

PNEUMATIC DIGITAL LINEAR GAGES



DUSTPROOF
WATERPROOF

ABSOLUTE ENCODER, THE ORIGINAL
DATA REMAINS AFTER POWER OFF



7134-10L

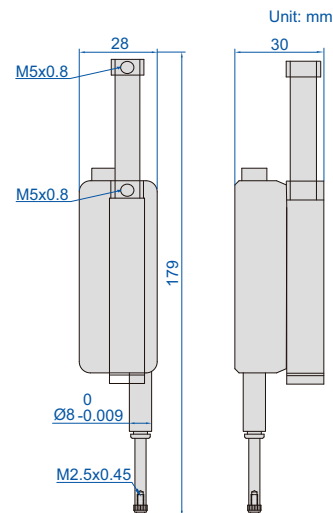

- Scale type: optical grating
- Absolute encoder, the original data remains after power off
- Digital signal output, amplifier is not required
- Air pressure: 0.2-0.5MPa
- Measuring force: $\leq 1.5\text{N}$
- Dust/waterproof: IP43/IP66
- Baud rate: 9600 (can be customized)
- Cable length: 3m (can be customized)



Dust/waterproof IP43, resolution 0.1 μm

Code	Range	Repeatability	Accuracy	Outgoing cable direction	Output signal	Output interface
7134-10	0-12.5mm	0.5 μm	1 μm	horizontal	RS232, TTL level	
7134-10L	0-12.5mm	0.5 μm	1 μm	vertical	RS232, TTL level	
7134-11	0-12.5mm	0.5 μm	1 μm	horizontal	RS232, 232 level	
7134-11L	0-12.5mm	0.5 μm	1 μm	vertical	RS232, 232 level	
7134-12	0-12.5mm	0.5 μm	1 μm	horizontal	RS485	
7134-12L	0-12.5mm	0.5 μm	1 μm	vertical	RS485	
7134-13	0-12.5mm	0.5 μm	1 μm	horizontal	RS232, TTL level	
7134-13L	0-12.5mm	0.5 μm	1 μm	vertical	RS232, TTL level	
7134-14	0-12.5mm	0.5 μm	1 μm	horizontal	RS232, 232 level	
7134-14L	0-12.5mm	0.5 μm	1 μm	vertical	RS232, 232 level	



Dust/waterproof IP43, resolution 0.5 μm

Code	Range	Repeatability	Accuracy	Outgoing cable direction	Output signal	Output interface
7134-20	0-12.5mm	1.5 μm	3 μm	horizontal	RS232, TTL level	
7134-20L	0-12.5mm	1.5 μm	3 μm	vertical	RS232, TTL level	
7134-21	0-12.5mm	1.5 μm	3 μm	horizontal	RS232, 232 level	
7134-21L	0-12.5mm	1.5 μm	3 μm	vertical	RS232, 232 level	
7134-22	0-12.5mm	1.5 μm	3 μm	horizontal	RS485	
7134-22L	0-12.5mm	1.5 μm	3 μm	vertical	RS485	
7134-23	0-12.5mm	1.5 μm	3 μm	horizontal	RS232, TTL level	
7134-23L	0-12.5mm	1.5 μm	3 μm	vertical	RS232, TTL level	
7134-24	0-12.5mm	1.5 μm	3 μm	horizontal	RS232, 232 level	
7134-24L	0-12.5mm	1.5 μm	3 μm	vertical	RS232, 232 level	

Dust/waterproof IP66, resolution 0.1µm

Code	Range	Repeatability	Accuracy	Outgoing cable direction	Output signal	Output interface
7134-30	0-12.5mm	0.5µm	1µm	horizontal	RS232, TTL level	
7134-30L	0-12.5mm	0.5µm	1µm	vertical	RS232, TTL level	
7134-31	0-12.5mm	0.5µm	1µm	horizontal	RS232, 232 level	
7134-31L	0-12.5mm	0.5µm	1µm	vertical	RS232, 232 level	
7134-32	0-12.5mm	0.5µm	1µm	horizontal	RS485	
7134-32L	0-12.5mm	0.5µm	1µm	vertical	RS485	
7134-33	0-12.5mm	0.5µm	1µm	horizontal	RS232, TTL level	
7134-33L	0-12.5mm	0.5µm	1µm	vertical	RS232, TTL level	
7134-34	0-12.5mm	0.5µm	1µm	horizontal	RS232, 232 level	
7134-34L	0-12.5mm	0.5µm	1µm	vertical	RS232, 232 level	

Dust/waterproof IP66, resolution 0.5µm

Code	Range	Repeatability	Accuracy	Outgoing cable direction	Output signal	Output interface
7134-40	0-12.5mm	1.5µm	3µm	horizontal	RS232, TTL level	
7134-40L	0-12.5mm	1.5µm	3µm	vertical	RS232, TTL level	
7134-41	0-12.5mm	1.5µm	3µm	horizontal	RS232, 232 level	
7134-41L	0-12.5mm	1.5µm	3µm	vertical	RS232, 232 level	
7134-42	0-12.5mm	1.5µm	3µm	horizontal	RS485	
7134-42L	0-12.5mm	1.5µm	3µm	vertical	RS485	
7134-43	0-12.5mm	1.5µm	3µm	horizontal	RS232, TTL level	
7134-43L	0-12.5mm	1.5µm	3µm	vertical	RS232, TTL level	
7134-44	0-12.5mm	1.5µm	3µm	horizontal	RS232, 232 level	
7134-44L	0-12.5mm	1.5µm	3µm	vertical	RS232, 232 level	