



LAMINA
TECHNOLOGIES



PRODUCT LINE

SWISS MANUFACTURER OF CARBIDE CUTTING TOOLS



LAMINA TECHNOLOGIES

PRODUCT CATALOG 2019 - 2020

TABLE OF CONTENTS

INTRODUCTION	3
TURNING	7
Aluminum Turning	39
Turning Tool Holders	45
Parting and Grooving	81
Thread Turning	87
MILLING	101
Face Milling	109
Shoulder Milling	127
High Feed Milling	145
Copy Milling	155
Slot Milling	167
Aluminum Milling	173
Solid End Mills	181
Thread Milling	199
Drilling	205
TECHNICAL INFORMATION	216
Machining Conditions	219
Technical Guide	351
Lamina Material Guide	377





SWISS MANUFACTURER OF CARBIDE CUTTING TOOLS

Lamina Technologies is a manufacturer of carbide cutting tools established in Switzerland.

From its inception, Lamina has been focused on understanding customers' needs and striving to exceed their expectations.

Since as early as 2003, we have been the global pioneers of the groundbreaking MULTI-MAT™ concept that, through innovative technologies, allows cutting tools to work on a multitude of materials. This reduces our customers' stock of unused and obsolete cutting tools, increases production flexibility and improves efficiency.

Our original ALPHA line of multi material cutting tools perform as good as or better than dedicated cutting tools from our competitors, on most materials.

Since 2012, we have complemented our offering by adding our MAGIA line, the highest performance cutting tools available.

Based on innovative tungsten carbide, CVD coating and our globally patented ultra thick hyper pulsed PVD coatings, we reach unparalleled performance.

Lamina continues its fast paced expansion with 7 subsidiaries and representation in over 50 countries.

PROUD SPONSOR OF JUNIOR NATIONAL TEAM OF



LAMINA'S DUAL PRODUCT LINE APPROACH

MAGIA

PREMIUM PRODUCT LINE
 MAGIA MULTI-MAT™ LT 1000, LT 3000 AND LT 4000
 MAGIA PRO LT 1110S, LT 1120M, LT 1125P, LT 3130

- Highest performance grades for top level machining
- Capable of outperforming the best on the market
- For customers that need ultimate performance

ALPHA

STANDARD PRODUCT LINE
 MULTI-MAT™ LT 10, LT 30 AND LT 40

- Lamina's original, pioneering universal grades
- Excellent performance at attractive price
- Best choice for machine shops with many short product runs and constant changes in workpiece material requiring the highest value for money

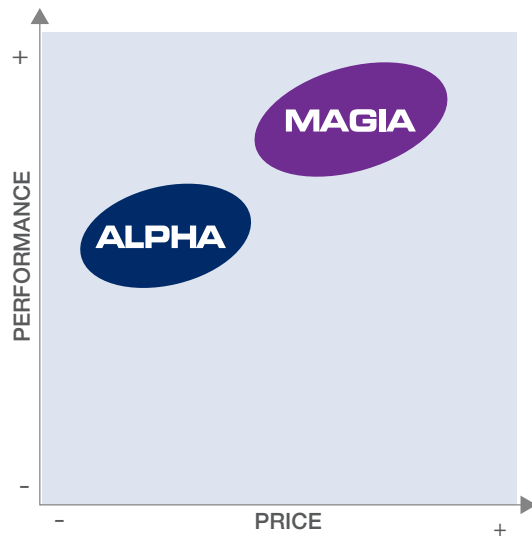

THE MULTI-MAT™ CONCEPT

The MULTI-MAT™ concept was conceived and developed by Lamina Technologies as a consequence of its understanding of the complexities faced by companies in the machining industry.

Through innovative sub-micron grades and advanced coatings, Lamina has developed a line of products that have excellent performance in wide variety of materials.

WHAT IS MULTI-MAT™?

- A focused range of multi material inserts
- Few grades required for all your machining needs
- Top quality Swiss manufacturing
- Reasonable price



MULTI-MAT™

TURNING

Simplify your process

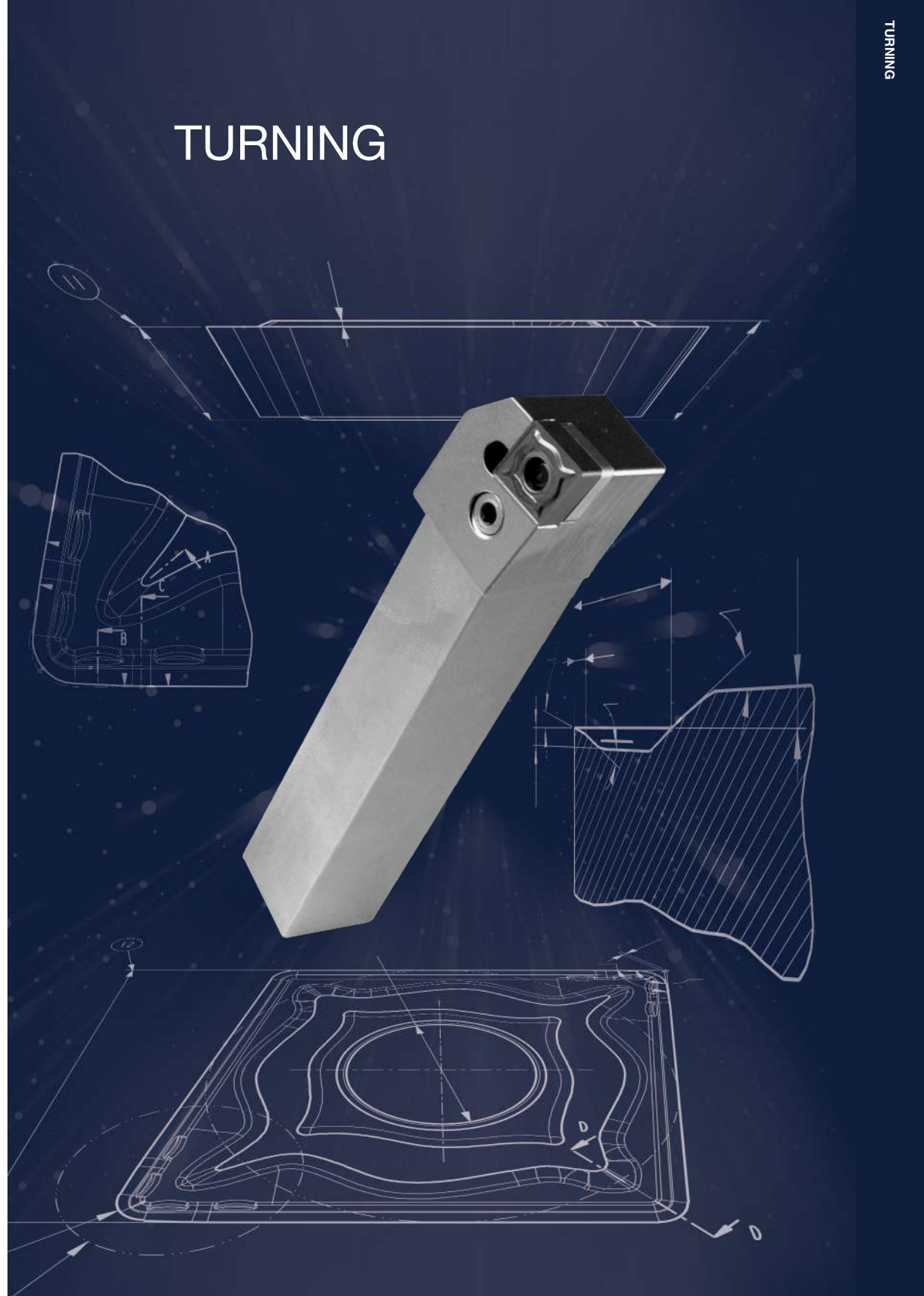

MAGIA TURNING GRADES

CHOOSE THE RIGHT PREMIUM TURNING GRADE

LT 1000

- Sub-micron PVD MULTI-MAT™, the most versatile of our MAGIA turning grades
- Excellent combination of hardness and toughness
- The first choice for customers with short production runs, different machining applications and different types of workpiece materials

MAGIA PRO TURNING GRADES

LT 1125P

- First choice, dedicated grade for turning steels
- Increased tool life
- Better reliability for machining all types of work pieces
- High wear resistance under demanding high temperature applications
- Impact resistance

LT 1120M

- First choice, dedicated grade for turning stainless steel
- Optimal balance between hardness and toughness
- Excellent for both stable and unstable conditions
- Works well in moderate to high speeds
- Outstanding wear resistance and extended tool life
- Enhanced built-up edge resistant

LT 1110S

- First choice, dedicated grade for turning high temperature alloys
- Combination of sub-micron substrate, nano-structured PVD coating reduce plastic deformation as well as notch and crater wear
- Innovative chipbreakers and precisely positioned deflectors facilitate chip flow and eliminate heat build up in the work zone
- Highly positive geometries provide better finish

INSERT DESIGNATION (BASED ON ISO 1832)



1. Insert Shape

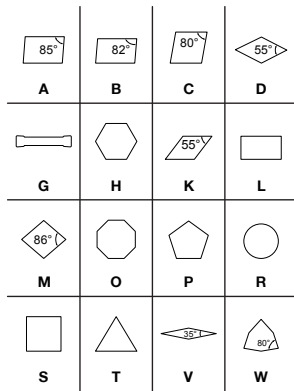

2. Clearance Angle

Letter Symbol	α
A	3°
B	5°
C	7°
D	15°
E	20°
F	25°
G	30°
N	0°
P	11°
O	Special

5. Cutting Edge Length

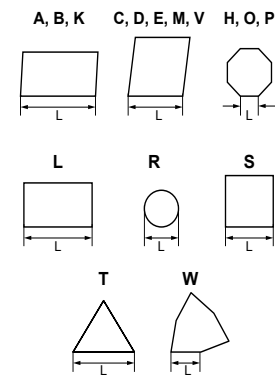

Disregarding any decimals e.g. 12,7 = 12

6. Insert Thickness

Symbol	mm
01	= 1.59
T1	= 1.98
02	= 2.38
03	= 3.18
T3	= 3.97
04	= 4.76
05	= 5.56
06	= 6.35
07	= 7.94
09	= 9.52

7. Insert Corner Radius

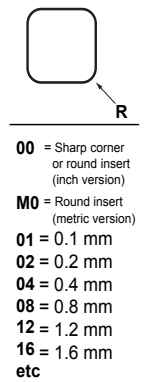

3. Tolerance Class

d (mm)	Symbol	D	M	S
m (mm)	A	± 0.025	± 0.005	± 0.025
s (mm)	C	± 0.025	± 0.013	± 0.025
	E	± 0.025	± 0.025	± 0.025
	F	± 0.013	± 0.005	± 0.025
	G	± 0.025	± 0.025	± 0.130
	H	± 0.013	± 0.013	± 0.025
	J*	± 0.05-0.15	± 0.005	± 0.025
	K*	± 0.05-0.15	± 0.013	± 0.025
	L*	± 0.05-0.15	± 0.025	± 0.025
	M*	± 0.05-0.15	± 0.08-0.20	± 0.130
	N*	± 0.05-0.15	± 0.08-0.20	± 0.025
	U*	± 0.08-0.25	± 0.13-0.38	± 0.130

* Depending on the insert size.

4. Fixing and Chipbreaker Types

Type	Symbol	Type	Symbol
A	[Symbol]	N	[Symbol]
B	[Symbol]	P	[Symbol]
F	[Symbol]	R	[Symbol]
G	[Symbol]	T	[Symbol]
H	[Symbol]	W	[Symbol]
M	[Symbol]	X	Special Design

8. Edge Preparation

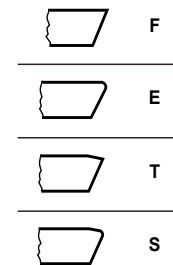

Optional information

9. Cutting Direction

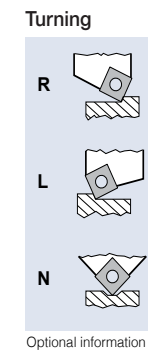

Optional information

10. Internal Designation

e.g. Chipbreaker (Turning)
 NN = General purpose
 NM = Roughing operations
 NX = General purpose Magia
 PP = All purpose grooving
 NS = Non-ferrous materials
 MP = Steel materials

Optional information

TURNING CHIPBREAKER RECOMMENDATIONS

NEGATIVE TURNING CHIPBREAKERS OVERVIEW

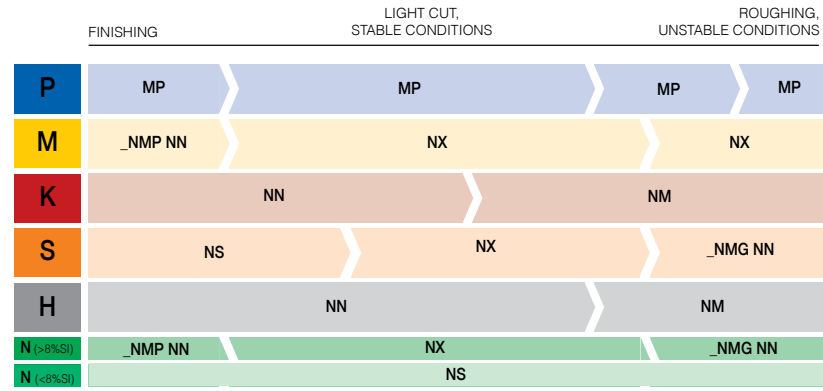

MULTI-MAT™ CHIPBREAKERS

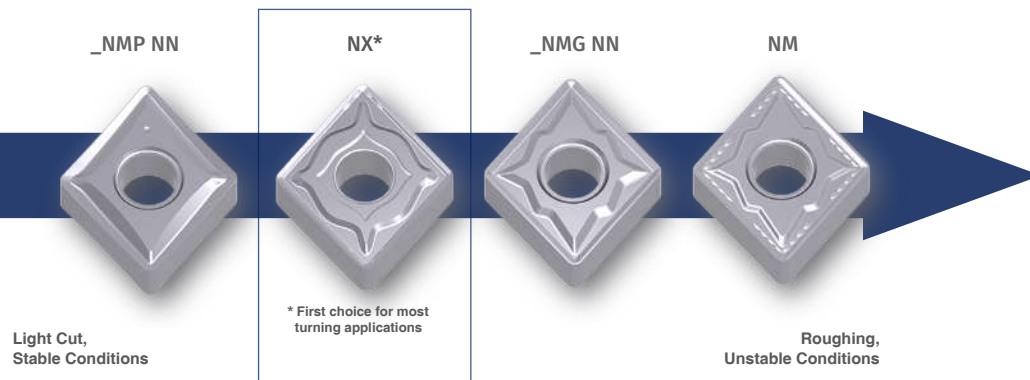

DEDICATED GEOMETRIES

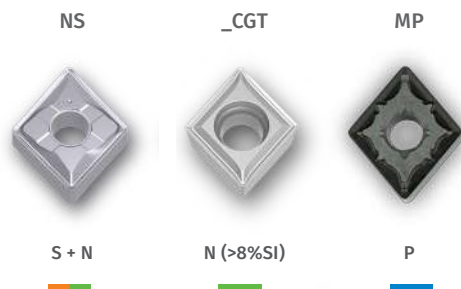

TURNING CHIPBREAKER FRAGMENTATION CHARTS

INSERT CORNER RADIUS = 0.8MM

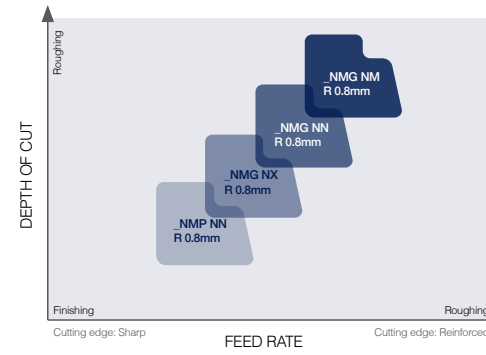

INSERT CORNER RADIUS = 0.4 AND 1.2

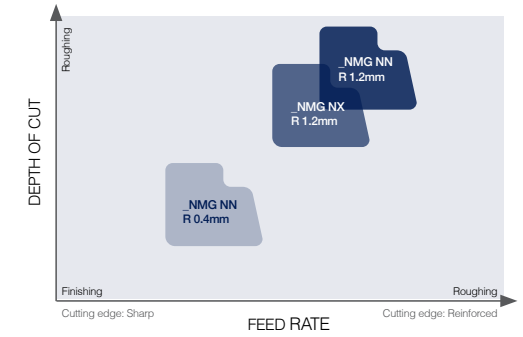

NS CHIPBREAKER

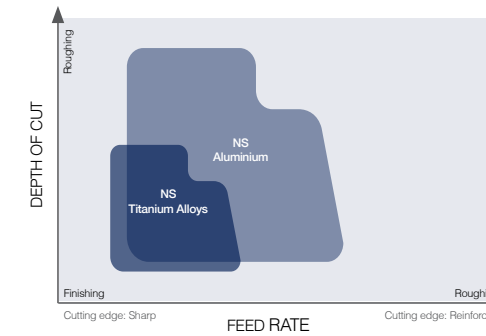

MP CHIPBREAKER

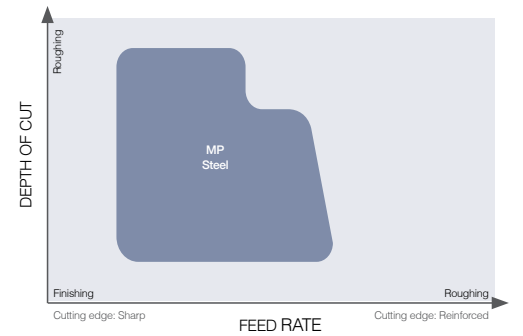

CCGT



NS Shown

MAGIA PRO

DESIGNATION	GRADE			V _c	CUTTING DATA	MATERIAL RECOMMENDATION	CATALOG #
CCGT 060204 NS	LT 1110S	●	●		p. 244		T0004671
CCGT 09T304 NS	LT 1110S	●	●		p. 244		T0004672

CNGG



NS Shown

MAGIA PRO

DESIGNATION	GRADE			V _c	CUTTING DATA	MATERIAL RECOMMENDATION	CATALOG #
CNGG 09T304 NS	LT 1110S	●	●		p. 244		T0004581
CNGG 120404 NS	LT 1110S	●	●		p. 244		T0004579
CNGG 120408 NS	LT 1110S	●	●		p. 244		T0004580

CCMT



NN Shown

MAGIA

DESIGNATION	GRADE			V _c	CUTTING DATA	MATERIAL RECOMMENDATION	CATALOG #
CCMT 060204 NN	LT 1000	●	●		p. 223		T0001888
CCMT 09T304 NN	LT 1000	●	●		p. 220		T0001889
CCMT 09T308 NN	LT 1000	●	●		p. 221		T0001890
CCMT 120404 NN	LT 1000	●	●		p. 220		T0001891
CCMT 120408 NN	LT 1000	●	●		p. 238		T0001892
CCMT 120412 NN	LT 1000	●	●		p. 222		T0001893

ALPHA

DESIGNATION	GRADE			V _c	CUTTING DATA	MATERIAL RECOMMENDATION	CATALOG #
CCMT 060204 NN	LT 10	●	●		p. 223		T0000055
CCMT 09T304 NN	LT 10	●	●		p. 220		T0000056
CCMT 09T308 NN	LT 10	●	●		p. 221		T0000117
CCMT 120404 NN	LT 10	●	●		p. 220		T0001456
CCMT 120408 NN	LT 10	●	●		p. 238		T0001457
CCMT 120412 NN	LT 10	●	●		p. 222		T0001776

CNMG



MP Shown

MAGIA PRO

DESIGNATION	GRADE			V _c	CUTTING DATA	MATERIAL RECOMMENDATION	CATALOG #
CNMG 120404 MP	LT 1125P	●	●		p. 249		T0004963
CNMG 120408 MP	LT 1125P	●	●		p. 249		T0004964
CNMG 120412 MP	LT 1125P	●	●		p. 250		T0004965
CNMG 160616 MP	LT 1125P	●	●		p. 250		T0005030
CNMG 120408 NX	LT 1120M	●	●		p. 247		T0004711
CNMG 120412 NX	LT 1120M	●	●		p. 247		T0004855
CNMG 120404 NN	LT 1110S	●	●		p. 248		T0004714
CNMG 120408 NX	LT 1110S	●	●		p. 247		T0004694
CNMG 120412 NX	LT 1110S	●	●		p. 247		T0004858

MAGIA

DESIGNATION	GRADE			V _c	CUTTING DATA	MATERIAL RECOMMENDATION	CATALOG #
CNMG 120404 NN	LT 1000	●	●		p. 220		T0001895
CNMG 120408 NX	LT 1000	●	●		p. 224		T0002741
CNMG 120408 NN	LT 1000	●	●		p. 225		T0001896
CNMG 120408 NM	LT 1000	●	●		p. 228		T0001968
CNMG 120412 NN	LT 1000	●	●		p. 226		T0001897
CNMG 120412 NX	LT 1000	●	●		p. 227		T0004859

	STABLE CONDITIONS		INTERRUPTED CUT	V _c	COOLANT	CHIPBREAKER	TECHNICAL SECTION
●	RECOMMENDED	●	RECOMMENDED				
◐	ACCEPTABLE	◐	ACCEPTABLE		p. 357	p. 12 - 13	p. 352 - 359
○	NOT RECOMMENDED	○	NOT RECOMMENDED				

MATERIAL GROUP	
	STEEL
	STAINLESS STEEL
	CAST IRON
	HIGH TEMP ALLOYS
	HARDENED MATERIAL
	ALU(>8%Si)

ORDERING EXAMPLE	
QUANTITY	10 PIECES
DESIGNATION + GRADE	CCMT 060204 NN LT 1000
CATALOG NUMBER	T0001888

C N M G

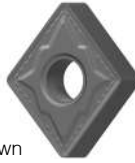

NM Shown

ALPHA

DESIGNATION	GRADE			V _c	CUTTING DATA	MATERIAL RECOMMENDATION	CATALOG #
CNMG 120404 NN	LT 10	●	◐		p. 220		T0000491
CNMG 120408 NN	LT 10	●	◐		p. 225		T0000059
CNMG 120408 NM	LT 10	●	◐		p. 228		T0001966
CNMG 120412 NN	LT 10	●	◐		p. 226		T0000061

C N M M



NR Shown

MAGIA

DESIGNATION	GRADE			V _c	CUTTING DATA	MATERIAL RECOMMENDATION	CATALOG #
CNMM 120412 NR	LT 1000	●	◐		p. 237		T0001899

ALPHA

DESIGNATION	GRADE			V _c	CUTTING DATA	MATERIAL RECOMMENDATION	CATALOG #
CNMM 120408 NR	LT 10	●	◐		p. 236		T0000669
CNMM 120412 NR	LT 10	●	◐		p. 237		T0000671

C N M P



NN Shown

MAGIA PRO

DESIGNATION	GRADE			V _c	CUTTING DATA	MATERIAL RECOMMENDATION	CATALOG #
CNMP 120408 NN	LT 1120M	●	◐		p. 248		T0004732
CNMP 120412 NN	LT 1120M	●	◐		p. 248		T0004734

MAGIA

DESIGNATION	GRADE			V _c	CUTTING DATA	MATERIAL RECOMMENDATION	CATALOG #
CNMP 120408 NN	LT 1000	●	○		p. 238		T0001900
CNMP 120412 NN	LT 1000	●	○		p. 222		T0001901

C P M T



NN Shown

MAGIA

DESIGNATION	GRADE			V _c	CUTTING DATA	MATERIAL RECOMMENDATION	CATALOG #
CPMT 060204 NN	LT 1000	●	◐		p. 223		T0003088
CPMT 060208 NN	LT 1000	●	◐		p. 243		T0003144
CPMT 09T304 NN	LT 1000	●	◐		p. 220		T0003145
CPMT 09T308 NN	LT 1000	●	◐		p. 221		T0003146

	STABLE CONDITIONS		INTERRUPTED CUT	V _c	COOLANT	CHIPBREAKER	TECHNICAL SECTION
●	RECOMMENDED	●	RECOMMENDED				
◐	ACCEPTABLE	◐	ACCEPTABLE		p. 357	p. 12 - 13	p. 352 - 359
○	NOT RECOMMENDED	○	NOT RECOMMENDED				

MATERIAL GROUP	
	STEEL
	STAINLESS STEEL
	CAST IRON
	HIGH TEMP ALLOYS
	HARDENED MATERIAL
	ALU(>8%SI)

ORDERING EXAMPLE	
QUANTITY	10 PIECES
DESIGNATION + GRADE	CCMT 060204 NN LT 1000
CATALOG NUMBER	T0001888

DCGT



NS Shown

MAGIA PRO

DESIGNATION	GRADE			V _c	CUTTING DATA	MATERIAL RECOMMENDATION	CATALOG #
DCGT 11T304 NS	LT 1110S	●	●		p. 244		T0004674

DCMT



NN Shown

MAGIA

DESIGNATION	GRADE			V _c	CUTTING DATA	MATERIAL RECOMMENDATION	CATALOG #
DCMT 070204 NN	LT 1000	●	●		p. 223		T0001902
DCMT 11T304 NN	LT 1000	●	●		p. 220		T0001903
DCMT 11T308 NN	LT 1000	●	●		p. 221		T0001904

ALPHA

DESIGNATION	GRADE			V _c	CUTTING DATA	MATERIAL RECOMMENDATION	CATALOG #
DCMT 070204 NN	LT 10	●	●		p. 223		T0000064
DCMT 11T304 NN	LT 10	●	●		p. 220		T0000065
DCMT 11T308 NN	LT 10	●	●		p. 221		T0000721

DNGG



NS Shown

MAGIA PRO

DESIGNATION	GRADE			V _c	CUTTING DATA	MATERIAL RECOMMENDATION	CATALOG #
DNGG 110404 NS	LT 1110S	●	●		p. 244		T0004593
DNGG 110408 NS	LT 1110S	●	●		p. 244		T0004606
DNGG 150604 NS	LT 1110S	●	●		p. 244		T0004561
DNGG 150608 NS	LT 1110S	●	●		p. 244		T0004562

DNMG



NX Shown

MAGIA PRO

DESIGNATION	GRADE			V _c	CUTTING DATA	MATERIAL RECOMMENDATION	CATALOG #
DNMG 110404 MP	LT 1125P	●	●		p. 249		T0004966
DNMG 110408 MP	LT 1125P	●	●		p. 249		T0004967
DNMG 150404 MP	LT 1125P	●	●		p. 249		T0004968
DNMG 150408 MP	LT 1125P	●	●		p. 249		T0004969
DNMG 150412 MP	LT 1125P	●	●		p. 250		T0004970
DNMG 150604 MP	LT 1125P	●	●		p. 249		T0004971
DNMG 150608 MP	LT 1125P	●	●		p. 249		T0004972
DNMG 150612 MP	LT 1125P	●	●		p. 250		T0004973
DNMG 110408 NN	LT 1120M	●	●		p. 248		T0004735
DNMG 150408 NX	LT 1120M	●	●		p. 247		T0004736
DNMG 150412 NN	LT 1120M	●	●		p. 248		T0004738
DNMG 150608 NX	LT 1120M	●	●		p. 247		T0004739
DNMG 150612 NN	LT 1120M	●	●		p. 248		T0004741
DNMG 150404 NN	LT 1110S	●	●		p. 246		T0004725
DNMG 150408 NX	LT 1110S	●	●		p. 245		T0004707
DNMG 150604 NN	LT 1110S	●	●		p. 246		T0004728
DNMG 150608 NX	LT 1110S	●	●		p. 245		T0004709

	STABLE CONDITIONS		INTERRUPTED CUT	V _c	COOLANT	CHIPBREAKER	TECHNICAL SECTION
●	RECOMMENDED	●	RECOMMENDED				
◐	ACCEPTABLE	◐	ACCEPTABLE		p. 357	p. 12 - 13	p. 352 - 359
○	NOT RECOMMENDED	○	NOT RECOMMENDED				

MATERIAL GROUP	
	STEEL
	STAINLESS STEEL
	CAST IRON
	HIGH TEMP ALLOYS
	HARDENED MATERIAL
	ALU(>8%Si)

ORDERING EXAMPLE	
QUANTITY	10 PIECES
DESIGNATION + GRADE	CCMT 060204 NN LT 1000
CATALOG NUMBER	T0001888



DNMG



NX Shown

MAGIA

DESIGNATION	GRADE			V _c	CUTTING DATA	MATERIAL RECOMMENDATION	CATALOG #
DNMG 110404 NN	LT 1000	●	◐		p. 220		T0001905
DNMG 110408 NN	LT 1000	●	◐		p. 225		T0001906
DNMG 150404 NN	LT 1000	●	◐		p. 220		T0001907
DNMG 150408 NX	LT 1000	●	◐		p. 224		T0003097
DNMG 150408 NN	LT 1000	●	◐		p. 225		T0001908
DNMG 150412 NN	LT 1000	●	◐		p. 226		T0001909
DNMG 150604 NN	LT 1000	●	◐		p. 220		T0001910
DNMG 150608 NX	LT 1000	●	◐		p. 224		T0003220
DNMG 150608 NN	LT 1000	●	◐		p. 225		T0001911
DNMG 150612 NN	LT 1000	●	◐		p. 226		T0001912

ALPHA

DESIGNATION	GRADE			V _c	CUTTING DATA	MATERIAL RECOMMENDATION	CATALOG #
DNMG 110404 NN	LT 10	●	◐		p. 220		T0000066
DNMG 110408 NN	LT 10	●	◐		p. 225		T0000675
DNMG 150404 NN	LT 10	●	◐		p. 220		T0000476
DNMG 150408 NN	LT 10	●	◐		p. 225		T0000475
DNMG 150412 NN	LT 10	●	◐		p. 226		T0001021
DNMG 150604 NN	LT 10	●	◐		p. 220		T0000583
DNMG 150608 NN	LT 10	●	◐		p. 225		T0000067
DNMG 150612 NN	LT 10	●	◐		p. 226		T0000672

DNUX



R Shown

MAGIA

DESIGNATION	GRADE			V _c	CUTTING DATA	MATERIAL RECOMMENDATION	CATALOG #
DNUX 150608 R11	LT 1000	●	◐		p. 224		T0002793

ALPHA

DESIGNATION	GRADE			V _c	CUTTING DATA	MATERIAL RECOMMENDATION	CATALOG #
DNUX 150608 R11	LT 10	●	◐		p. 224		T0002157

	STABLE CONDITIONS		INTERRUPTED CUT	V _c	COOLANT	CHIPBREAKER	TECHNICAL SECTION
●	RECOMMENDED	●	RECOMMENDED				
◐	ACCEPTABLE	◐	ACCEPTABLE		p. 357	p. 12 - 13	p. 352 - 359
○	NOT RECOMMENDED	○	NOT RECOMMENDED				

MATERIAL GROUP		ORDERING EXAMPLE	
	STEEL		HIGH TEMP ALLOYS
	STAINLESS STEEL		HARDENED MATERIAL
	CAST IRON		ALU(>8%SI)
QUANTITY	10 PIECES	DESIGNATION + GRADE	CMPT 060204 NN LT 1000
CATALOG NUMBER	T0001888		

KNUX



R Shown

ALPHA

DESIGNATION	GRADE			V _c	CUTTING DATA	MATERIAL RECOMMENDATION	CATALOG #
KNUX 160405 L	LT 10	●	◐		p. 224		T0003884
KNUX 160405 R	LT 10	●	◐		p. 224		T0000951

K

STABLE CONDITIONS
 ● RECOMMENDED
 ◐ ACCEPTABLE
 ○ NOT RECOMMENDED

INTERRUPTED CUT
 ● RECOMMENDED
 ◐ ACCEPTABLE
 ○ NOT RECOMMENDED

V_c

COOLANT

 p. 357

CHIPBREAKER

 p. 12 - 13

TECHNICAL SECTION

 p. 352 - 359

MATERIAL GROUP
 STEEL
 STAINLESS STEEL
 CAST IRON
 HIGH TEMP ALLOYS
 HARDENED MATERIAL
 ALU(>8%SI)

ORDERING EXAMPLE
 QUANTITY 10 PIECES
 DESIGNATION + GRADE CCMT 060204 NN LT 1000
 CATALOG NUMBER T0001888

RCMT



M0 Shown

MAGIA

DESIGNATION	GRADE			V _c	CUTTING DATA	MATERIAL RECOMMENDATION	CATALOG #
RCMT 0602 M0	LT 1000	●	◐		p. 239		T0001914
RCMT 0803 M0	LT 1000	●	◐		p. 240		T0001915
RCMT 10T3 M0	LT 1000	●	◐		p. 241		T0001916
RCMT 1204 M0	LT 1000	●	◐		p. 242		T0001917

ALPHA

DESIGNATION	GRADE			V _c	CUTTING DATA	MATERIAL RECOMMENDATION	CATALOG #
RCMT 0602 M0	LT 10	●	◐		p. 239		T0000090
RCMT 0803 M0	LT 10	●	◐		p. 240		T0000091
RCMT 10T3 M0	LT 10	●	◐		p. 241		T0000092
RCMT 1204 M0	LT 10	●	◐		p. 242		T0000093

STABLE CONDITIONS
 ● RECOMMENDED
 ◐ ACCEPTABLE
 ○ NOT RECOMMENDED

INTERRUPTED CUT
 ● RECOMMENDED
 ◐ ACCEPTABLE
 ○ NOT RECOMMENDED

V_c

COOLANT

 p. 357

CHIPBREAKER

 p. 12 - 13

TECHNICAL SECTION

 p. 352 - 359

MATERIAL GROUP
 STEEL
 STAINLESS STEEL
 CAST IRON
 HIGH TEMP ALLOYS
 HARDENED MATERIAL
 ALU(>8%SI)

ORDERING EXAMPLE
 QUANTITY 10 PIECES
 DESIGNATION + GRADE RCMT 060204 NN LT 1000
 CATALOG NUMBER T0001888

SCMT



NN Shown

MAGIA

DESIGNATION	GRADE			Vc	CUTTING DATA	MATERIAL RECOMMENDATION	CATALOG #
SCMT 09T304 NN	LT 1000	●	●		p. 220		T0001918
SCMT 09T308 NN	LT 1000	●	●		p. 221		T0001919

ALPHA

DESIGNATION	GRADE			Vc	CUTTING DATA	MATERIAL RECOMMENDATION	CATALOG #
SCMT 09T304 NN	LT 10	●	●		p. 220		T0001459
SCMT 09T308 NN	LT 10	●	●		p. 221		T0001458

SNMG



NX Shown

MAGIA PRO

DESIGNATION	GRADE			Vc	CUTTING DATA	MATERIAL RECOMMENDATION	CATALOG #
SNMG 120408 MP	LT 1125P	●	●		p. 249		T0004974
SNMG 120412 MP	LT 1125P	●	●		p. 250		T0004975
SNMG 120408 NX	LT 1120M	●	●		p. 247		T0004742
SNMG 120408 NX	LT 1110S	●	●		p. 245		T0004698

MAGIA

DESIGNATION	GRADE			Vc	CUTTING DATA	MATERIAL RECOMMENDATION	CATALOG #
SNMG 120408 NX	LT 1000	●	●		p. 229		T0003011
SNMG 120408 NN	LT 1000	●	●		p. 230		T0001921
SNMG 120412 NN	LT 1000	●	●		p. 231		T0001922

ALPHA

DESIGNATION	GRADE			Vc	CUTTING DATA	MATERIAL RECOMMENDATION	CATALOG #
SNMG 120408 NN	LT 10	●	●		p. 230		T0000322
SNMG 120412 NN	LT 10	●	●		p. 231		T0000323

S

	STABLE CONDITIONS		INTERRUPTED CUT	Vc	COOLANT	CHIPBREAKER	TECHNICAL SECTION
●	RECOMMENDED	●	RECOMMENDED				
◐	ACCEPTABLE	◐	ACCEPTABLE		p. 357	p. 12 - 13	p. 352 - 359
○	NOT RECOMMENDED	○	NOT RECOMMENDED				

MATERIAL GROUP		ORDERING EXAMPLE
	STEEL	QUANTITY
	STAINLESS STEEL	10 PIECES
	CAST IRON	DESIGNATION + GRADE
	HIGH TEMP ALLOYS	CCMT 060204 NN LT 1000
	HARDENED MATERIAL	CATALOG NUMBER
	ALU(>8%SI)	T0001888

TCMT



NN Shown

MAGIA

DESIGNATION	GRADE			Vc	CUTTING DATA	MATERIAL RECOMMENDATION	CATALOG #
TCMT 110204 NN	LT 1000	●	○		p. 223		T0001924
TCMT 110208 NN	LT 1000	●	○		p. 243		T0001925
TCMT 16T304 NN	LT 1000	●	○		p. 220		T0001927
TCMT 16T308 NN	LT 1000	●	○		p. 238		T0001928
TCMT 16T312 NN	LT 1000	●	○		p. 222		T0001929

ALPHA

DESIGNATION	GRADE			Vc	CUTTING DATA	MATERIAL RECOMMENDATION	CATALOG #
TCMT 110204 NN	LT 10	●	○		p. 223		T0000477
TCMT 110208 NN	LT 10	●	○		p. 243		T0000478
TCMT 16T304 NN	LT 10	●	○		p. 220		T0000479
TCMT 16T308 NN	LT 10	●	○		p. 238		T0000068
TCMT 16T312 NN	LT 10	●	○		p. 222		T0001774

TNGG



NS Shown

MAGIA PRO

DESIGNATION	GRADE			Vc	CUTTING DATA	MATERIAL RECOMMENDATION	CATALOG #
TNGG 160404 NS	LT 1110S	●	○		p. 244		T0004608
TNGG 160408 NS	LT 1110S	●	○		p. 244		T0004609

TNMG



NX Shown

MAGIA PRO

DESIGNATION	GRADE			Vc	CUTTING DATA	MATERIAL RECOMMENDATION	CATALOG #
TNMG 160404 MP	LT 1125P	●	○		p. 249		T0004976
TNMG 160408 MP	LT 1125P	●	○		p. 249		T0004977
TNMG 160412 MP	LT 1125P	●	○		p. 250		T0004978
TNMG 220408 MP	LT 1125P	●	○		p. 249		T0004979
TNMG 220412 MP	LT 1125P	●	○		p. 250		T0004980
TNMG 160408 NX	LT 1120M	●	○		p. 247		T0004746
TNMG 220408 NX	LT 1120M	●	○		p. 247		T0004748
TNMG 160404 NN	LT 1110S	●	○		p. 246		T0004719
TNMG 160408 NX	LT 1110S	●	○		p. 247		T0004700
TNMG 220404 NN	LT 1110S	●	○		p. 246		T0004724
TNMG 220408 NX	LT 1110S	●	○		p. 247		T0004703

MAGIA

DESIGNATION	GRADE			Vc	CUTTING DATA	MATERIAL RECOMMENDATION	CATALOG #
TNMG 160404 NN	LT 1000	●	○		p. 220		T0001931
TNMG 160408 NX	LT 1000	●	○		p. 224		T0003012
TNMG 160408 NN	LT 1000	●	○		p. 225		T0001932
TNMG 160412 NN	LT 1000	●	○		p. 226		T0001933
TNMG 220404 NN	LT 1000	●	○		p. 220		T0001934
TNMG 220408 NX	LT 1000	●	○		p. 224		T0003013
TNMG 220408 NN	LT 1000	●	○		p. 225		T0001935
TNMG 220412 NN	LT 1000	●	○		p. 226		T0001936

ALPHA

DESIGNATION	GRADE			Vc	CUTTING DATA	MATERIAL RECOMMENDATION	CATALOG #
TNMG 160404 NN	LT 10	●	○		p. 220		T0000457
TNMG 160408 NN	LT 10	●	○		p. 225		T0000069
TNMG 160412 NN	LT 10	●	○		p. 226		T0001734
TNMG 220404 NN	LT 10	●	○		p. 220		T0001873
TNMG 220408 NN	LT 10	●	○		p. 225		T0000113
TNMG 220412 NN	LT 10	●	○		p. 226		T0001735

	STABLE CONDITIONS		INTERRUPTED CUT	Vc	COOLANT	CHIPBREAKER	TECHNICAL SECTION
●	RECOMMENDED	●	RECOMMENDED				
◐	ACCEPTABLE	◐	ACCEPTABLE		p. 357	p. 12 - 13	p. 352 - 359
○	NOT RECOMMENDED	○	NOT RECOMMENDED				

MATERIAL GROUP		ORDERING EXAMPLE
	STEEL	QUANTITY
	STAINLESS STEEL	10 PIECES
	CAST IRON	DESIGNATION + GRADE
	HIGH TEMP ALLOYS	CCMT 060204 NN LT 1000
	HARDENED MATERIAL	CATALOG NUMBER
	ALU(>8%SI)	T0001888



T N M P



NN Shown

MAGIA PRO

DESIGNATION	GRADE			V _c	CUTTING DATA	MATERIAL RECOMMENDATION	CATALOG #
TNMP 160408 NN	LT 1120M	●	●		p. 248		T0004754

MAGIA

DESIGNATION	GRADE			V _c	CUTTING DATA	MATERIAL RECOMMENDATION	CATALOG #
TNMP 160408 NN	LT 1000	●	○		p. 238		T0001937

ALPHA

DESIGNATION	GRADE			V _c	CUTTING DATA	MATERIAL RECOMMENDATION	CATALOG #
TNMP 160408 NN	LT 10	●	○		p. 238		T0000492

T N U X



R Shown

MAGIA

DESIGNATION	GRADE			V _c	CUTTING DATA	MATERIAL RECOMMENDATION	CATALOG #
TNUX 160404 L	LT 1000	●	○		p. 220		T0002794
TNUX 160404 R	LT 1000	●	○		p. 220		T0001938
TNUX 160408 L	LT 1000	●	●		p. 224		T0002795
TNUX 160408 R	LT 1000	●	●		p. 224		T0001939

ALPHA

DESIGNATION	GRADE			V _c	CUTTING DATA	MATERIAL RECOMMENDATION	CATALOG #
TNUX 160404 L	LT 10	●	○		p. 220		T0001877
TNUX 160404 R	LT 10	●	○		p. 220		T0001125
TNUX 160408 L	LT 10	●	●		p. 224		T0003385
TNUX 160408 R	LT 10	●	●		p. 224		T0001137

T P M R



NN Shown

ALPHA

DESIGNATION	GRADE			V _c	CUTTING DATA	MATERIAL RECOMMENDATION	CATALOG #
TPMR 160304 NN	LT 10	●	●		p. 220		T0001638
TPMR 160308 NN	LT 10	●	●		p. 238		T0001535

	STABLE CONDITIONS		INTERRUPTED CUT	V _c	COOLANT	CHIPBREAKER	TECHNICAL SECTION
●	RECOMMENDED	●	RECOMMENDED				
●	ACCEPTABLE	●	ACCEPTABLE		p. 357	p. 12 - 13	p. 352 - 359
○	NOT RECOMMENDED	○	NOT RECOMMENDED				

MATERIAL GROUP	
	STEEL
	STAINLESS STEEL
	CAST IRON
	HIGH TEMP ALLOYS
	HARDENED MATERIAL
	ALU(>8%SI)

ORDERING EXAMPLE	
QUANTITY	10 PIECES
DESIGNATION + GRADE	CCMT 060204 NN LT 1000
CATALOG NUMBER	T0001888

VBMT



NN Shown

MAGIA

DESIGNATION	GRADE			V _c	CUTTING DATA	MATERIAL RECOMMENDATION	CATALOG #
VBMT 110304 NN	LT 1000	●	●		p. 223		T0001942
VBMT 160404 NN	LT 1000	●	●		p. 220		T0001943
VBMT 160408 NN	LT 1000	●	●		p. 221		T0001944

ALPHA

DESIGNATION	GRADE			V _c	CUTTING DATA	MATERIAL RECOMMENDATION	CATALOG #
VBMT 110304 NN	LT 10	●	●		p. 223		T0001460
VBMT 160404 NN	LT 10	●	●		p. 220		T0000070
VBMT 160408 NN	LT 10	●	●		p. 221		T0000071

VCGT



NS Shown

MAGIA PRO

DESIGNATION	GRADE			V _c	CUTTING DATA	MATERIAL RECOMMENDATION	CATALOG #
VCGT 160404 NS	LT 1110S	●	●		p. 244		T0004563
VCGT 160408 NS	LT 1110S	●	●		p. 244		T0004565

VCMT



NN Shown

MAGIA

DESIGNATION	GRADE			V _c	CUTTING DATA	MATERIAL RECOMMENDATION	CATALOG #
VCMT 160404 NN	LT 1000	●	●		220		T0001945
VCMT 160408 NN	LT 1000	●	●		221		T0001946

ALPHA

DESIGNATION	GRADE			V _c	CUTTING DATA	MATERIAL RECOMMENDATION	CATALOG #
VCMT 160404 NN	LT 10	●	●		p. 220		T0001102
VCMT 160408 NN	LT 10	●	●		p. 221		T0001103

VNGG



NS Shown

MAGIA PRO

DESIGNATION	GRADE			V _c	CUTTING DATA	MATERIAL RECOMMENDATION	CATALOG #
VNGG 160404 NS	LT 1110S	●	●		p. 244		T0004571
VNGG 160408 NS	LT 1110S	●	●		p. 244		T0004575

	STABLE CONDITIONS		INTERRUPTED CUT	V _c	COOLANT		CHIPBREAKER		TECHNICAL SECTION
●	RECOMMENDED	●	RECOMMENDED						
◐	ACCEPTABLE	◐	ACCEPTABLE		p. 357	p. 12 - 13			p. 352 - 359
○	NOT RECOMMENDED	○	NOT RECOMMENDED						

	STEEL		HIGH TEMP ALLOYS
	STAINLESS STEEL		HARDENED MATERIAL
	CAST IRON		ALU(>8%SI)

ORDERING EXAMPLE

QUANTITY	10 PIECES
DESIGNATION + GRADE	CCMT 060204 NN LT 1000
CATALOG NUMBER	T0001888



V N M G



NN Shown

MAGIA PRO

DESIGNATION	GRADE			V _c	CUTTING DATA	MATERIAL RECOMMENDATION	CATALOG #
VNMG 160408 NN	LT 1120M	●	●		p. 248		T0004756
VNMG 160404 MP	LT 1125P	●	●		p. 249		T0004981
VNMG 160408 MP	LT 1125P	●	●		p. 249		T0004982

MAGIA

DESIGNATION	GRADE			V _c	CUTTING DATA	MATERIAL RECOMMENDATION	CATALOG #
VNMG 160404 NN	LT 1000	●	●		p. 220		T0001947
VNMG 160408 NN	LT 1000	●	●		p. 221		T0001948

ALPHA

DESIGNATION	GRADE			V _c	CUTTING DATA	MATERIAL RECOMMENDATION	CATALOG #
VNMG 160404 NN	LT 10	●	●		p. 220		T0000072
VNMG 160408 NN	LT 10	●	●		p. 221		T0000073

W N G G



NS Shown

MAGIA PRO

DESIGNATION	GRADE			V _c	CUTTING DATA	MATERIAL RECOMMENDATION	CATALOG #
WNGG 060404 NS	LT 1110S	●	●		p. 244		T0004610
WNGG 060408 NS	LT 1110S	●	●		p. 244		T0004611
WNGG 080404 NS	LT 1110S	●	●		p. 244		T0004612
WNGG 080408 NS	LT 1110S	●	●		p. 244		T0004613

	STABLE CONDITIONS		INTERRUPTED CUT	V _c	COOLANT	CHIPBREAKER	TECHNICAL SECTION
●	RECOMMENDED	●	RECOMMENDED				
◐	ACCEPTABLE	◐	ACCEPTABLE		p. 357	p. 12 - 13	p. 352 - 359
○	NOT RECOMMENDED	○	NOT RECOMMENDED				

	STEEL		HIGH TEMP ALLOYS
	STAINLESS STEEL		HARDENED MATERIAL
	CAST IRON		ALU(>8%Si)

ORDERING EXAMPLE

QUANTITY	10 PIECES
DESIGNATION + GRADE	CCMT 060204 NN LT 1000
CATALOG NUMBER	T0001888



W N M G



NN Shown

MAGIA PRO

DESIGNATION	GRADE			V _c	CUTTING DATA	MATERIAL RECOMMENDATION	CATALOG #
WNMG 060408 MP	LT 1125P	●	●		p. 250		T0004983
WNMG 080404 MP	LT 1125P	●	●		p. 249		T0004984
WNMG 080408 MP	LT 1125P	●	●		p. 250		T0004990
WNMG 080412 MP	LT 1125P	●	●		p. 250		T0004989
WNMG 060408 NX	LT 1120M	●	●		p. 247		T0004758
WNMG 080408 NX	LT 1120M	●	●		p. 247		T0004759
WNMG 060404 NN	LT 1110S	●	○		p. 246		T0004716
WNMG 060408 NX	LT 1110S	●	○		p. 245		T0004695
WNMG 080404 NN	LT 1110S	●	○		p. 246		T0004717
WNMG 080408 NX	LT 1110S	●	○		p. 245		T0004696
WNMG 080412 NN	LT 1110S	●	○		p. 246		T0004718

MAGIA

DESIGNATION	GRADE			V _c	CUTTING DATA	MATERIAL RECOMMENDATION	CATALOG #
WNMG 060404 NN	LT 1000	●	○		p. 220		T0001949
WNMG 060408 NX	LT 1000	●	○		p. 232		T0003014
WNMG 060408 NN	LT 1000	●	○		p. 233		T0001950
WNMG 080404 NN	LT 1000	●	○		p. 220		T0001951
WNMG 080408 NX	LT 1000	●	○		p. 232		T0002742
WNMG 080408 NN	LT 1000	●	○		p. 233		T0001952
WNMG 080408 NM	LT 1000	●	○		p. 235		T0001969
WNMG 080412 NN	LT 1000	●	○		p. 234		T0001953

ALPHA

DESIGNATION	GRADE			V _c	CUTTING DATA	MATERIAL RECOMMENDATION	CATALOG #
WNMG 060404 NN	LT 10	●	○		p. 220		T0000133
WNMG 060408 NN	LT 10	●	○		p. 233		T0000137
WNMG 080404 NN	LT 10	●	○		p. 220		T0000584
WNMG 080408 NN	LT 10	●	○		p. 233		T0000075
WNMG 080408 NM	LT 10	●	○		p. 235		T0001967
WNMG 080412 NN	LT 10	●	○		p. 234		T0000077

W N M P



NN Shown

MAGIA PRO

DESIGNATION	GRADE			V _c	CUTTING DATA	MATERIAL RECOMMENDATION	CATALOG #
WNMP 080408 NN	LT 1120M	●	○		p. 248		T0004762

MAGIA

DESIGNATION	GRADE			V _c	CUTTING DATA	MATERIAL RECOMMENDATION	CATALOG #
WNMP 060404 NN	LT 1000	●	○		p. 220		T0001954
WNMP 060408 NN	LT 1000	●	○		p. 233		T0001955
WNMP 080408 NN	LT 1000	●	○		p. 233		T0001956

ALPHA

DESIGNATION	GRADE			V _c	CUTTING DATA	MATERIAL RECOMMENDATION	CATALOG #
WNMP 060404 NN	LT 10	●	○		p. 220		T0000306
WNMP 060408 NN	LT 10	●	○		p. 233		T0000307
WNMP 080408 NN	LT 10	●	○		p. 233		T0000308

	STABLE CONDITIONS		INTERRUPTED CUT	V _c	COOLANT	CHIPBREAKER	TECHNICAL SECTION
●	RECOMMENDED	●	RECOMMENDED				
○	ACCEPTABLE	○	ACCEPTABLE		p. 357	p. 12 - 13	p. 352 - 359
○	NOT RECOMMENDED	○	NOT RECOMMENDED				

MATERIAL GROUP	
	STEEL
	STAINLESS STEEL
	CAST IRON
	HIGH TEMP ALLOYS
	HARDENED MATERIAL
	ALU(>8%SI)

ORDERING EXAMPLE	
QUANTITY	10 PIECES
DESIGNATION + GRADE	CCMT 060204 NN LT 1000
CATALOG NUMBER	T0001888

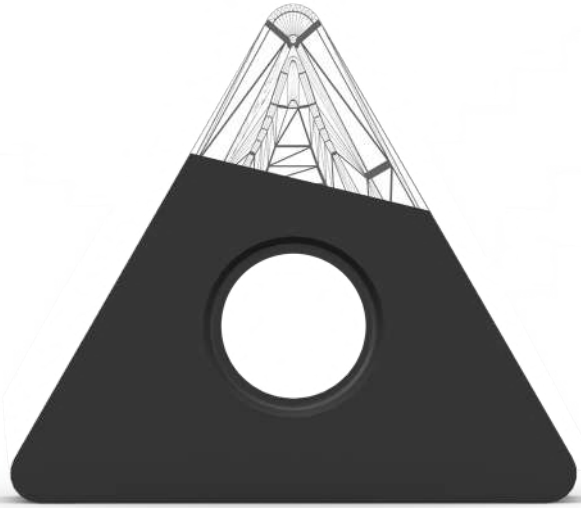

MADE IN SWITZERLAND



ALU TURNING

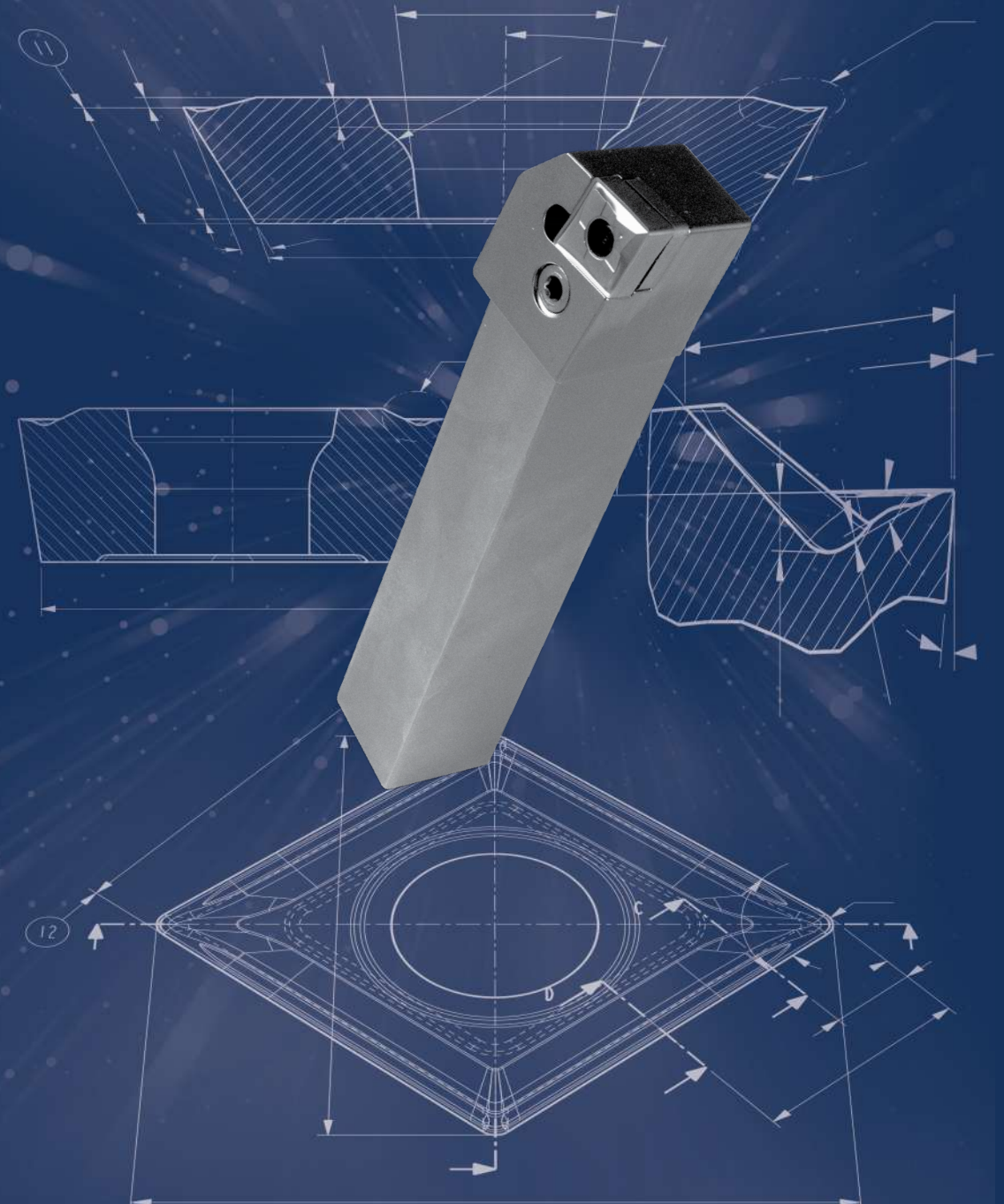

ALU
TURNING

LT 05

IMPROVED TURNING INSERTS FOR ALUMINIUM AND OTHER NON FERROUS MATERIALS

Our long lasting aluminium line has been improved by combining our unique PVD coating and sub-micron substrate with the newly designed NS chipbreaker for flawless aluminium turning.

The new NS chipbreaker has a larger supporting area in the pocket seat which provides greater stability and thus a better surface finish.

Lamina aluminium _CGT turning geometries are single sided positive inserts while our economic _NGG geometries are doubled sided and fit all standard ISO tool holders.

- Specially designed deflectors facilitate chip breaking and enhancing chip evacuation
- Larger supporting area in the pocket seat for greater stability and better surface finish
- Our unique PVD coating has low affinity for aluminium, eliminates built-up edge
- Sharp edges slide through aluminium without sticking

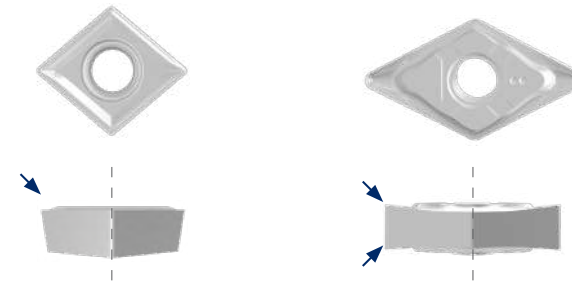

STANDARD SINGLE POSITIVE INSERTS
_CGT

LAMINA DOUBLE SIDED ALTERNATIVE
_NGG

CCGT



DESIGNATION	GRADE	MATERIAL RECOMMENDATION	CATALOG #
CCGT 060204 NS	LT 05		T0004773
CCGT 09T304 NS	LT 05		T0004774

CN GG



DESIGNATION	GRADE	MATERIAL RECOMMENDATION	CATALOG #
CN GG 09T304 NS	LT 05		T0004578
CN GG 120404 NS	LT 05		T0004576
CN GG 120408 NS	LT 05		T0004577

DCGT



DESIGNATION	GRADE	MATERIAL RECOMMENDATION	CATALOG #
DCGT 11T304 NS	LT 05		T0004775

DN GG



DESIGNATION	GRADE	MATERIAL RECOMMENDATION	CATALOG #
DN GG 110404 NS	LT 05		T0004589
DN GG 110408 NS	LT 05		T0004601
DN GG 150604 NS	LT 05		T0004403
DN GG 150608 NS	LT 05		T0004404

VCGT



DESIGNATION	GRADE	MATERIAL RECOMMENDATION	CATALOG #
VCGT 160404 NS	LT 05		T0004564
VCGT 160408 NS	LT 05		T0004566

VN GG



DESIGNATION	GRADE	MATERIAL RECOMMENDATION	CATALOG #
VN GG 160404 NS	LT 05		T0002830
VN GG 160408 NS	LT 05		T0002831

T N G G



DESIGNATION	GRADE	MATERIAL RECOMMENDATION	CATALOG #
TNGG 160404 NS	LT 05	■	T0004602
TNGG 160408 NS	LT 05	■	T0004603

W N G G



DESIGNATION	GRADE	MATERIAL RECOMMENDATION	CATALOG #
WNGG 060404 NS	LT 05	■	T0004605
WNGG 060408 NS	LT 05	■	T0004551
WNGG 080404 NS	LT 05	■	T0004598
WNGG 080408 NS	LT 05	■	T0004552

TURNING TOOL HOLDERS

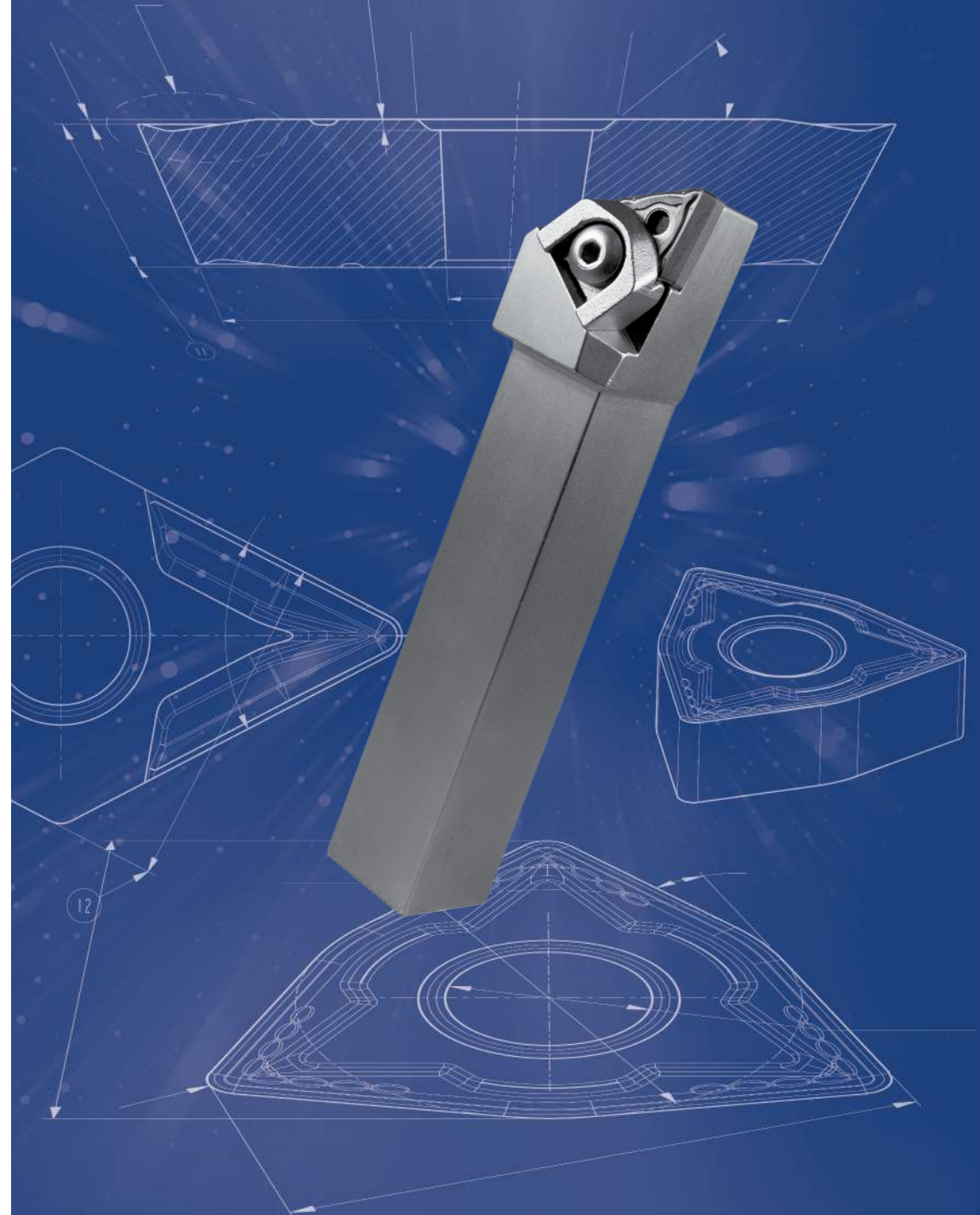

TURNING
TOOL
HOLDERS

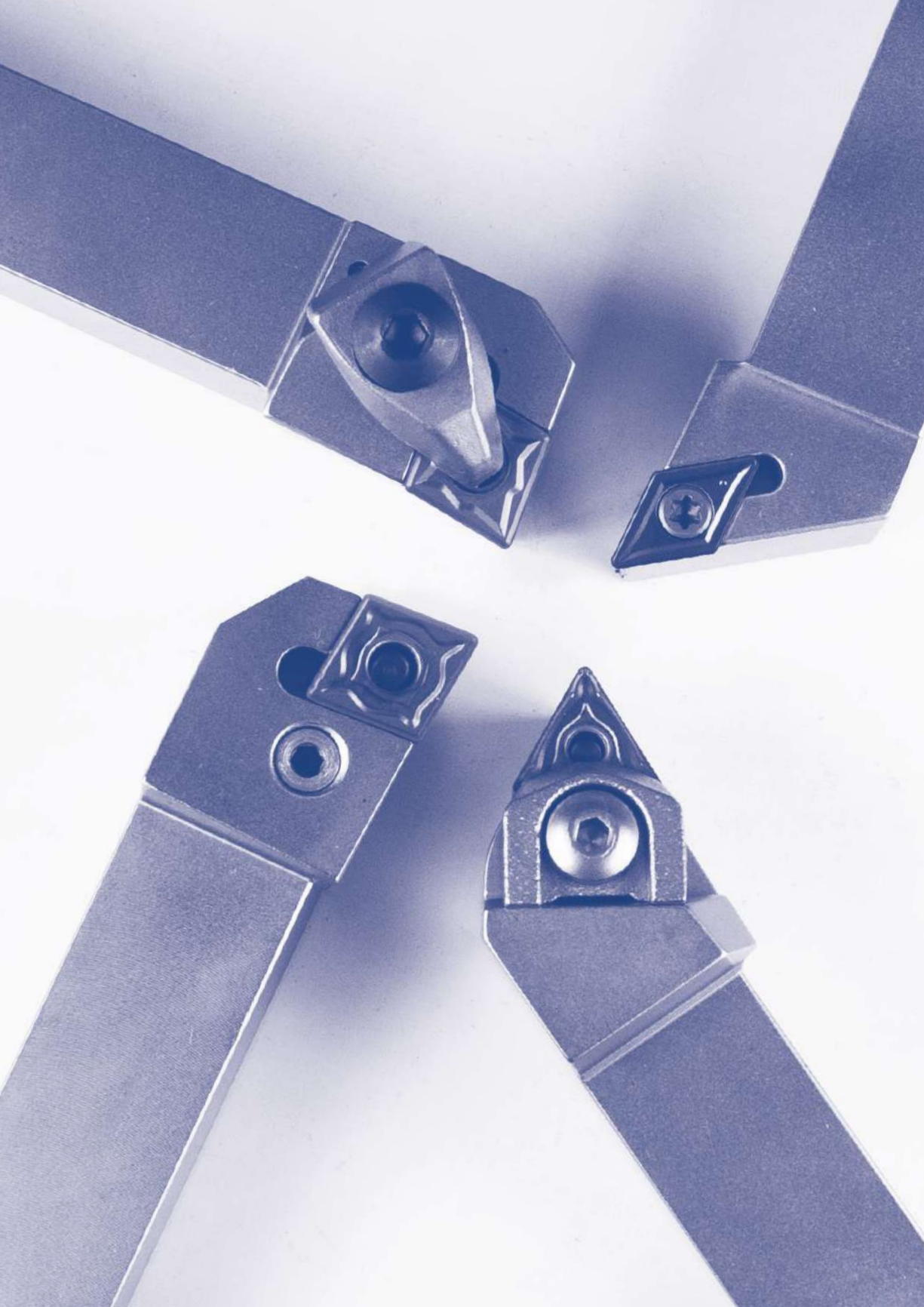

High quality tool holders for Turning operations.

- Available for all Lamina inserts geometries
- Internal and external operations
- Options with internal coolant

P	C	L	N	L	25	25	M	12
4	5	6	7	8	9	10	3	11
A	25	S	P	C	L	N	L	12
1	2	3	4	5	6	7	8	11

1. Boring Bar

- S** Steel Shank
- A** Coolant through Steel Shank
- C** Solid Carbide Shank
- E** Coolant through Carbide Shank

2. Bar Diameter

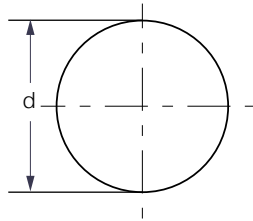

3. Tool Length

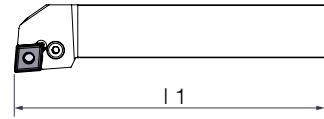

A = 32	H = 100	Q = 180
B = 40	J = 110	R = 200
C = 50	K = 125	S = 250
D = 60	L = 140	T = 300
E = 70	M = 150	U = 350
F = 80	N = 160	V = 400
G = 90	P = 170	W = 450
		X = 500
		Y = Special

4. Clamping System

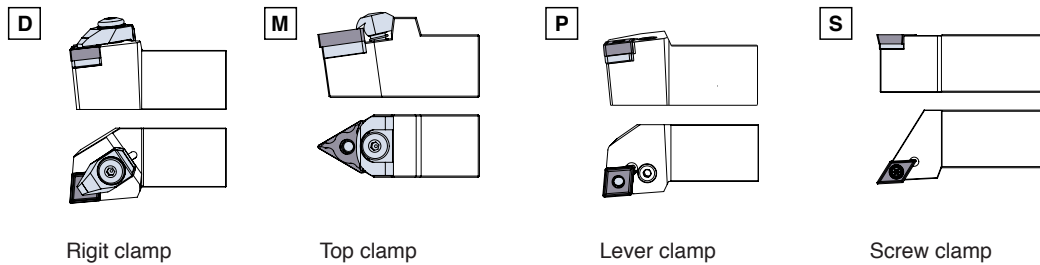

5. Insert shape

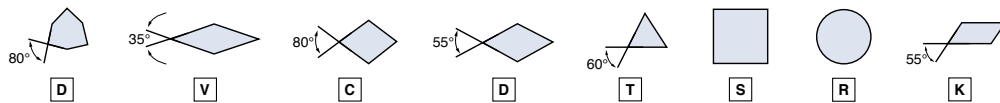

6. Approach Angle

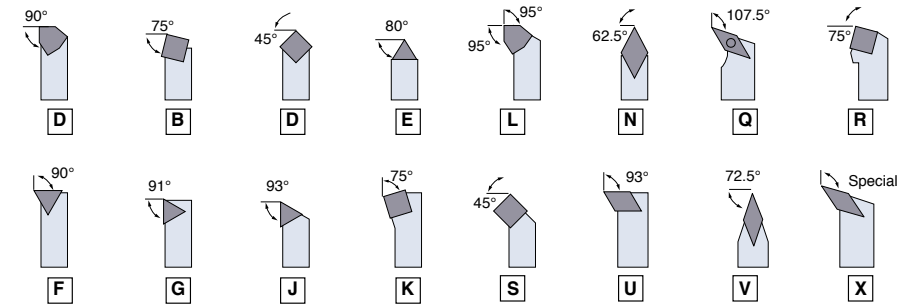

7. Insert Clearance Angle

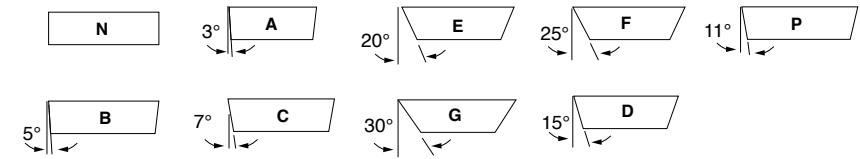

8. Hand of tool

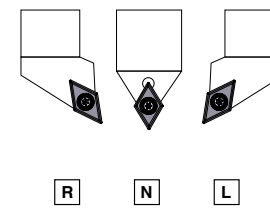

9. Shank Height

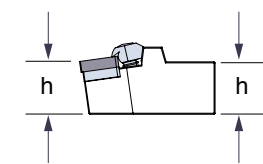

9. Shank Width

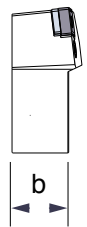

11. Insert Size

Cutting edge length

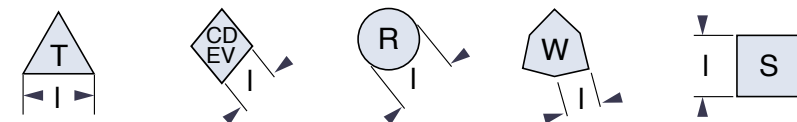

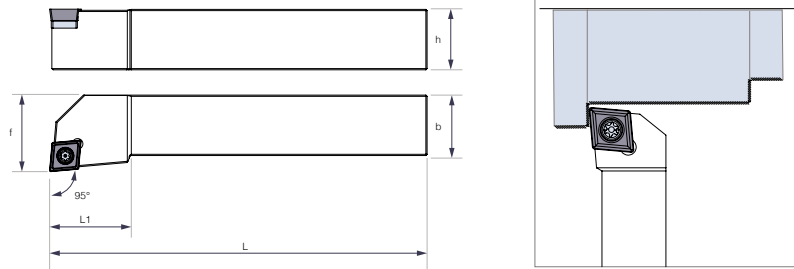

DESIGNATION	L	H	B	F	INSERT	CATALOG #
SCLCR 1010 J06	110	10	10	12	CC.. 0602	T2002910
SCLCL 1010 J06	110	10	10	12		T2005138

ACCESSORIES PAGE 74 - 79

* Tool holders and accessories on request

DESIGNATION	L	H	B	F	INSERT	CATALOG #
SCLCR 1212 J09	110	12	12	16	CC.. 09T3	T2005139
SCLCL 1212 J09	110	12	12	16		T2005140
SCLCR 1616 H09	100	16	16	20		T2005141
SCLCL 1616 H09	100	16	16	20		T2005142
SCLCR 2020 K09	125	20	20	25	CC.. 1204	T2005120
SCLCL 2020 K09	125	20	20	25		T2005098
SCLCR 2020 K12	125	20	20	25		T2005069
SCLCL 2020 K12	125	20	20	25		T2005070
SCLCR 2525 M12	150	25	25	32	CC.. 1204	T2002920
SCLCL 2525 M12	150	25	25	32		T2005298

ACCESSORIES PAGE 74 - 79

* Tool holders and accessories on request

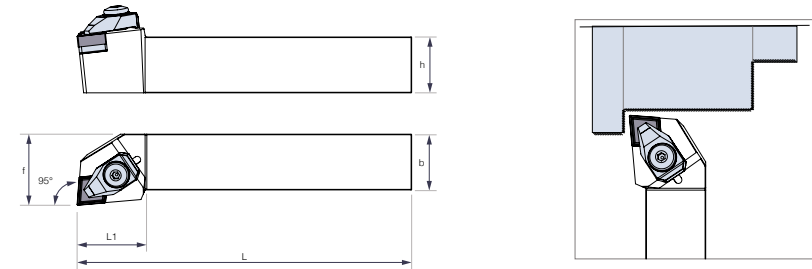

DESIGNATION	L	H	B	F	INSERT	CATALOG #
DCLNR 2020 K12	125	20	20	25	CN.. 1204	T2005072
DCLNL 2020 K12	125	20	20	25		T2005073
DCLNR 2525 M12	150	25	25	32		T2005299
DCLNL 2525 M12	150	25	25	32		T2005313
DCLNR 3232 P12	170	32	32	40	CN.. 1204	T2005314
DCLNL 3232 P12	170	32	32	40		T2005315

ACCESSORIES PAGE 74 - 79

* Tool holders and accessories on request

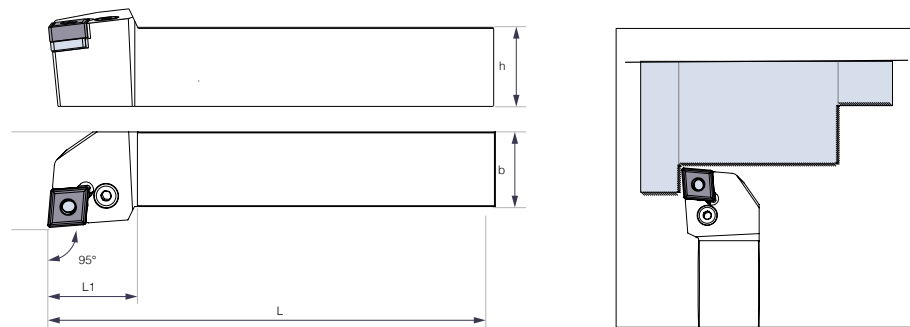

DESIGNATION	L	H	B	F	INSERT	CATALOG #
PCLNR 1616 H12	100	16	16	20	CN.. 1204	T2005063
PCLNL 1616 H12	100	16	16	20		T2005064
PCLNR 2020 K12	125	20	20	25		T2005065
PCLNL 2020 K12	125	20	20	25		T2005066
PCLNR 2525 M12	150	25	25	32		T2005306
PCLNL 2525 M12	150	25	25	32		T2005307

ACCESSORIES PAGE 74 - 79

* Tool holders and accessories on request

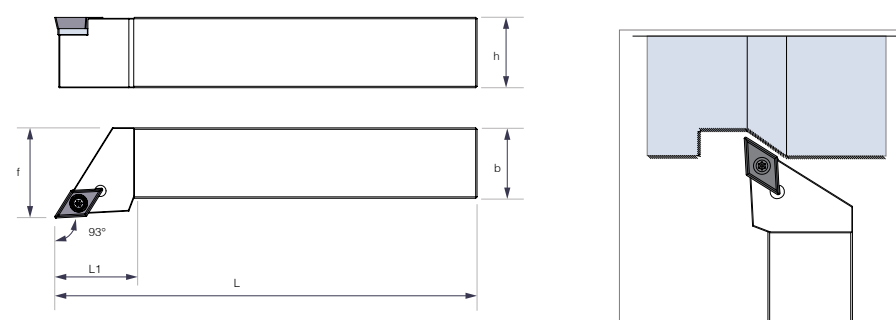

DESIGNATION	L	H	B	F	INSERT	CATALOG #
SDJCR 1010 J07	110	10	10	10	DC.. 0702	T2005067
SDJCL 1010 J07	110	10	10	10		T2005068
SDJCR 1212 J07	110	12	12	12		T2005076
SDJCL 1212 J07	110	12	12	12		T2005084
SDJCR 1616 H07	100	16	16	16		T2005085
SDJCL 1616 H07	100	16	16	16		T2005086

ACCESSORIES PAGE 74 - 79

* Tool holders and accessories on request

DESIGNATION	L	H	B	F	INSERT	CATALOG #
SDJCR 1616 H11	110	16	16	20	DC.. 11T3	T2005087
SDJCL 1616 H11	110	16	16	20		T2005088
SDJCR 2020 K11	125	20	20	25		T2005089
SDJCL 2020 K11	125	20	20	25		T2005090
SDJCR 2525 M11	150	25	25	32		T2005308
SDJCL 2525 M11	150	25	25	32		T2005309

ACCESSORIES PAGE 74 - 79

* Tool holders and accessories on request

EXTERNAL TURNING TOOL HOLDERS

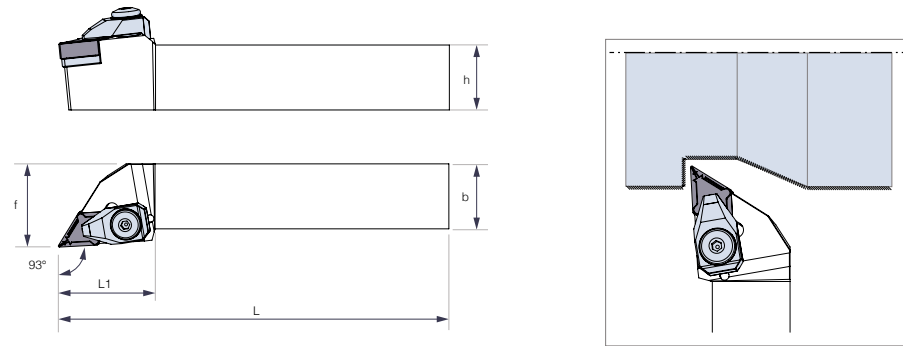

DESIGNATION	L	H	B	F	INSERT	CATALOG #
DDJNR 2020 K11	125	20	20	25	DN.. 1104	T2005077
DDJNL 2020 K11	125	20	20	25		T2005078
DDJNR 2525 M11	150	25	25	32		T2005310
DDJNL 2525 M11	150	25	25	32		T2005321

ACCESSORIES PAGE 74 - 79

* Tool holders and accessories on request

DESIGNATION	L	H	B	F	INSERT	CATALOG #
DDJNR 2020 K15	125	20	20	25	DN.. 1506	T2005061
DDJNL 2020 K15	125	20	20	25		T2005039
DDJNR 2525 M15	150	25	25	32		T2005255
DDJNL 2525 M15	150	25	25	32		T2005254
DDJNR 2020 K1504	125	20	20	25	DN.. 1504	T2005080
DDJNL 2020 K1504	125	20	20	25		T2005081
DDJNR 2525 M1504	150	25	25	32		T2005322
DDJNL 2525 M1504	150	25	25	32		T2005284

ACCESSORIES PAGE 74 - 79

* Tool holders and accessories on request

EXTERNAL TURNING TOOL HOLDERS

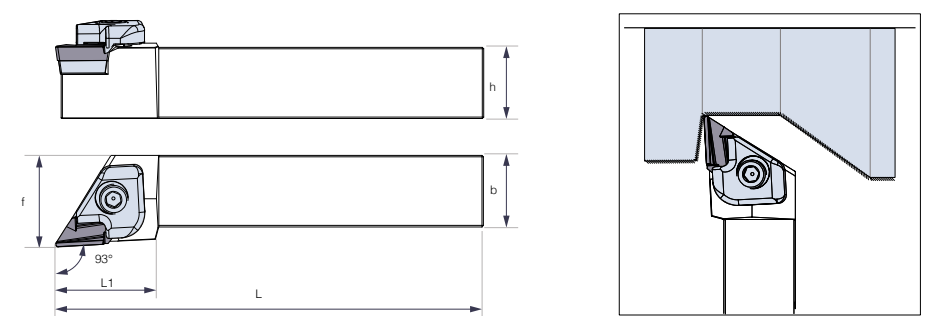

DESIGNATION	L	H	B	F	INSERT	CATALOG #
CKJNR 2020 K16	125	20	20	26.5	KNUX 1604	T2005042
CKJNL 2020 K16	125	20	20	26.5		T2005043
CKJNR 2525 M16	150	25	25	30		T2005251
CKJNL 2525 M16	150	25	25	30		T2005276

ACCESSORIES PAGE 74 - 79

* Tool holders and accessories on request

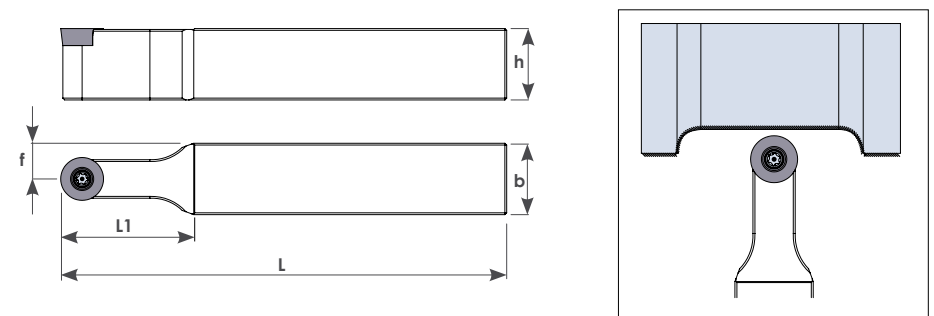

DESIGNATION	L	H	B	F	INSERT	CATALOG #
SRDCN 2020 K06	125	20	20	10	RC.. 0602	T2005032
SRDCN 2525 M06	150	25	25	12.5		T2005275

ACCESSORIES PAGE 74 - 79

* Tool holders and accessories on request

EXTERNAL TURNING TOOL HOLDERS

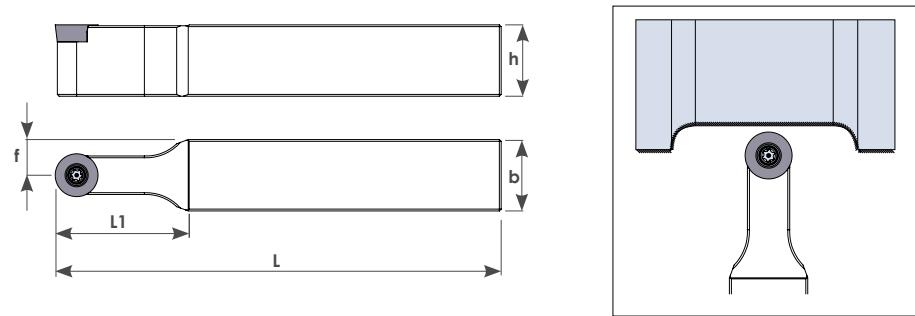

DESIGNATION	L	H	B	F	INSERT	CATALOG #
SRDCN 2020 K08	125	20	20	10	RC.. 0803	T2005034
SRDCN 2525 M08	150	25	25	12.5		T2005273

ACCESSORIES PAGE 74 - 79

* Tool holders and accessories on request

DESIGNATION	L	H	B	F	INSERT	CATALOG #
SRDCN 2020 K10	125	20	20	10	RC.. 10T3	T2005036
SRDCN 2525 M10	150	25	25	12.5		T2005279

ACCESSORIES PAGE 74 - 79

* Tool holders and accessories on request

DESIGNATION	L	H	B	F	INSERT	CATALOG #
SRDCN 2020 K12	125	20	20	10	RC.. 1204	T2005038
SRDCN 2525 M12	150	25	25	12.5		T2005264

ACCESSORIES PAGE 74 - 79

* Tool holders and accessories on request

EXTERNAL TURNING TOOL HOLDERS

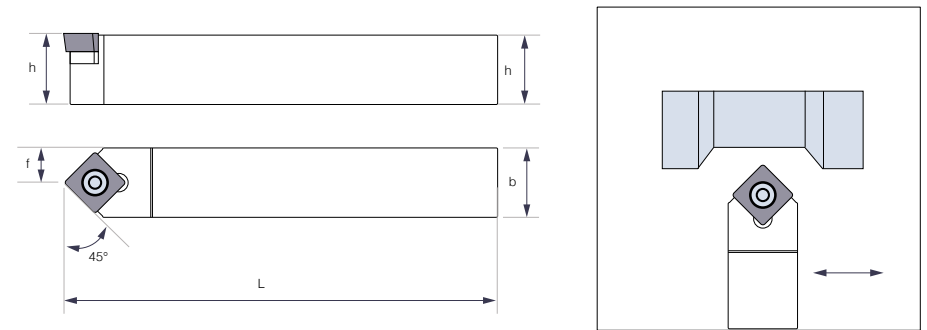

DESIGNATION	L	H	B	F	INSERT	CATALOG #
SSDCN 1616 H09	100	16	16	6	SC.. 09T3	T2005054
SSDCN 2020 K09	125	20	20	10		T2005055

ACCESSORIES PAGE 74 - 79

* Tool holders and accessories on request

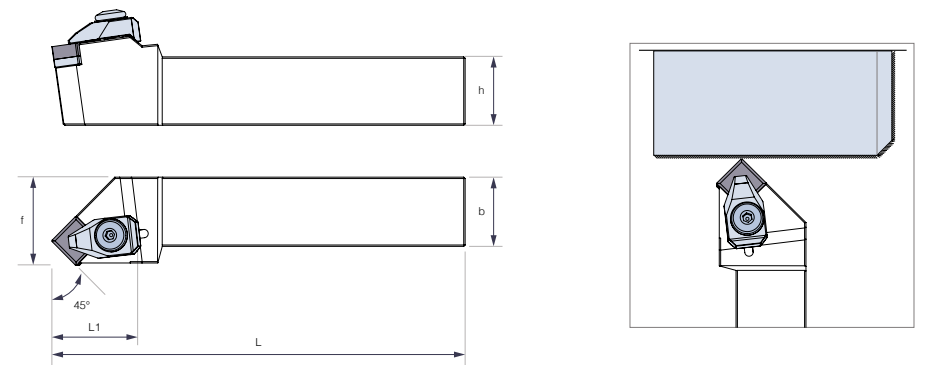

DESIGNATION	L	H	B	F	INSERT	CATALOG #
DSSNR 2020 K12	100	20	20	25	SN.. 1204	T2005056
DSSNR 2525 M12	125	25	25	32		T2005271

ACCESSORIES PAGE 74 - 79

* Tool holders and accessories on request

EXTERNAL TURNING TOOL HOLDERS

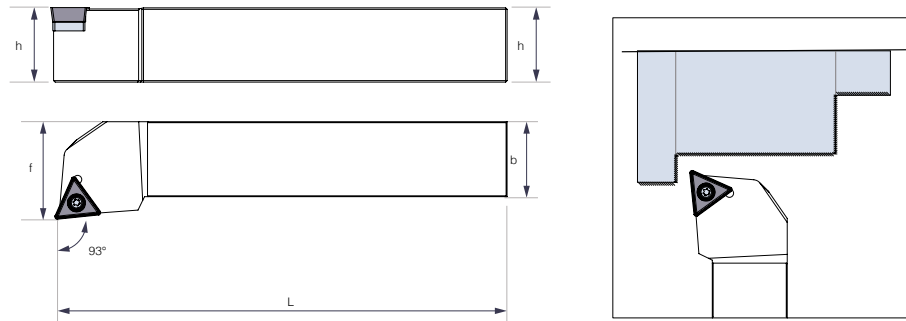

DESIGNATION	L	H	B	F	INSERT	CATALOG #
STJCR 1212 F11	80	12	12	16	TC.. 1102	T2005058
STJCL 1212 F11	80	12	12	16		T2005059
STJCR 1616 H11	100	16	16	20		T2005057
STJCL 1616 H11	100	16	16	20		T2005046

ACCESSORIES PAGE 74 - 79

* Tool holders and accessories on request

DESIGNATION	L	H	B	F	INSERT	CATALOG #
STJCR 1616 H16	100	16	16	20	TC.. 16T3	T2005037
STJCL 1616 H16	100	16	16	20		T2005035
STJCR 2020 K16	125	20	20	25		T2005033
STJCL 2020 K16	125	20	20	25		T2005045
STJCR 2525 M16	150	25	25	32		T2005041
STJCL 2525 M16	150	25	25	32		T2005044

ACCESSORIES PAGE 74 - 79

* Tool holders and accessories on request

EXTERNAL TURNING TOOL HOLDERS

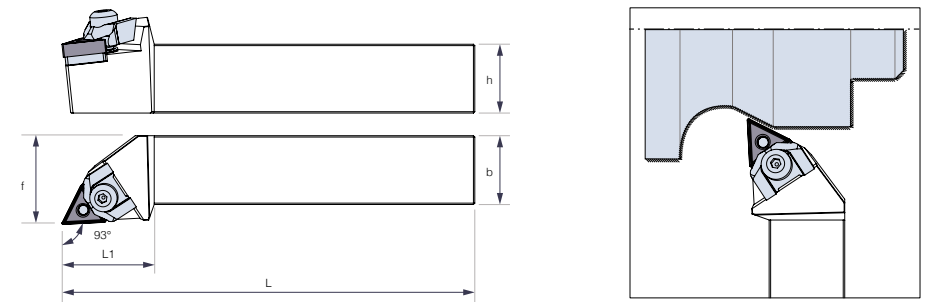

DESIGNATION	L	H	B	F	INSERT	CATALOG #
MTJNR 2020 K16	125	20	20	25	TN.. 1604	T2005040
MTJNL 2020 K16	125	20	20	25		T2005083
MTJNR 2525 M16	150	25	25	32		T2005082
MTJNL 2525 M16	150	25	25	32		T2005079
MTJNR 3232 P16	170	32	32	40		T2005280
MTJNL 3232 P16	170	32	32	40		T2005282

ACCESSORIES PAGE 74 - 79

* Tool holders and accessories on request

DESIGNATION	L	H	B	F	INSERT	CATALOG #
MTJNR 2525 M22	150	25	25	32	TN.. 2204	T2005283
MTJNL 2525 M22	150	25	25	32		T2005252
MTJNR 3232 P22	170	32	32	40		T2005253
MTJNL 3232 P22	170	32	32	40		T2005256

ACCESSORIES PAGE 74 - 79

* Tool holders and accessories on request

EXTERNAL TURNING TOOL HOLDERS

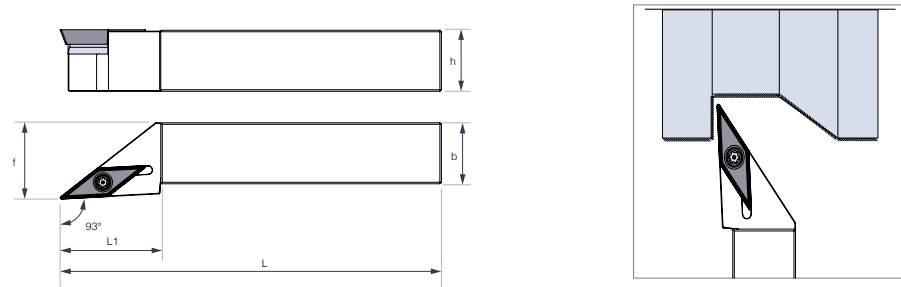

DESIGNATION	L	H	B	F	INSERT	CATALOG #
SVJBR 1212 J11	110	12	12	12	VB.. 1103	T2005062
SVJBL 1212 J11	110	12	12	12		T2005075
SVJBR 1616 H11	100	16	16	16		T2005074
SVJBL 1616 H11	100	16	16	16		T2005071
SVJBR 2020 K11	125	20	20	25		T2005127
SVJBL 2020 K11	125	20	20	25		T2005135

ACCESSORIES PAGE 74 - 79

* Tool holders and accessories on request

EXTERNAL TURNING TOOL HOLDERS

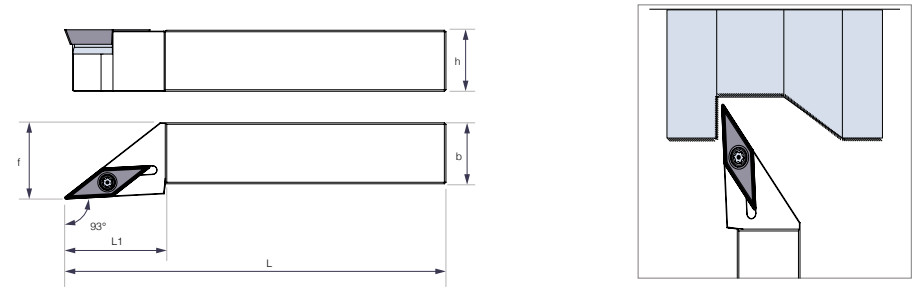

DESIGNATION	L	H	B	F	INSERT	CATALOG #
SVJBR 1616 H16	100	16	16	20	VB.. 1604	T2005143
SVJBL 1616 H16	100	16	16	20		T2005144
SVJBR 2020 K16	125	20	20	25		T2005145
SVJBL 2020 K16	125	20	20	25		T2005146
SVJBR 2525 M16	150	25	25	32		T2005274
SVJBL 2525 M16	150	25	25	32		T2005278

ACCESSORIES PAGE 74- 79

* Tool holders and accessories on request

EXTERNAL TURNING TOOL HOLDERS

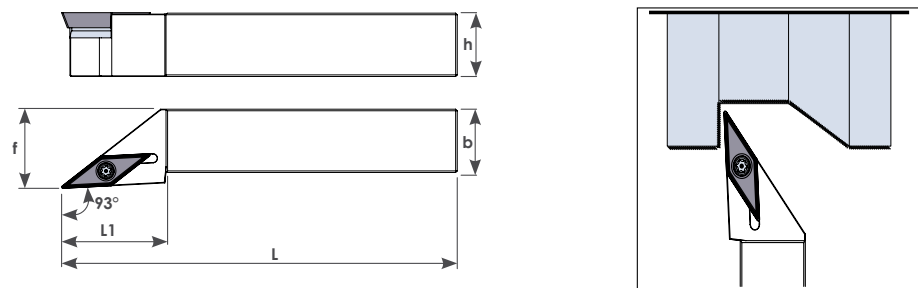

DESIGNATION	L	H	B	F	INSERT	CATALOG #
SVJCR 2020 K16	125	20	20	25	VC.. 1604	T2005148
SVJCL 2020 K16	125	20	20	25		T2005149
SVJCR 2525 M16	150	25	25	32		T2005265
SVJCL 2525 M16	150	25	25	32		T2005270

ACCESSORIES PAGE 74 - 79

* Tool holders and accessories on request

EXTERNAL TURNING TOOL HOLDERS

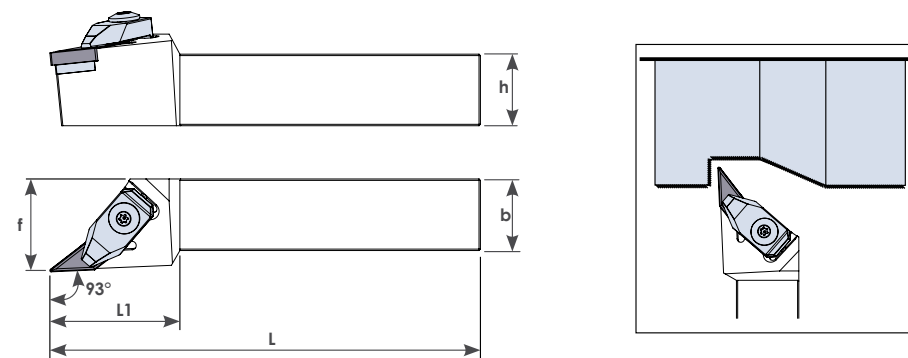

DESIGNATION	L	H	B	F	INSERT	CATALOG #
DVJNR 2020 K16	125	20	20	25	VN.. 1604	T2005137
DVJNL 2020 K16	125	20	20	25		T2005157
DVJNR 2525 M16	150	25	25	32		T2005163
DVJNL 2525 M16	150	25	25	32		T2005267

ACCESSORIES PAGE 74 - 79

* Tool holders and accessories on request

EXTERNAL TURNING TOOL HOLDERS

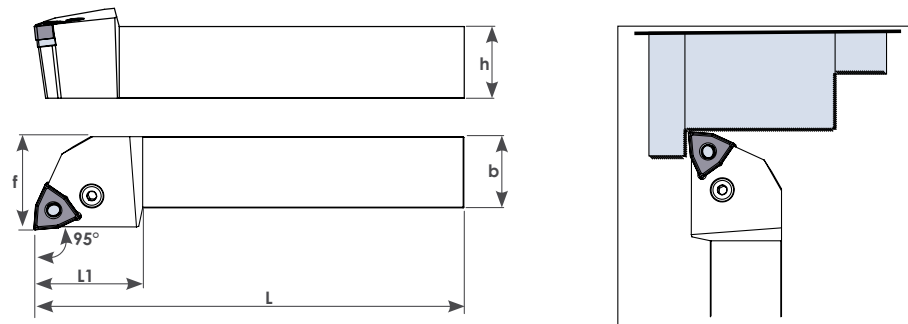

DESIGNATION	L	H	B	F	INSERT	CATALOG #
PWLNK 2020 K06	100	20	20	25	WN.. 0604	T2005160
PWLNK 2020 K06	100	20	20	25		T2005171
PWLNK 2525 M06	150	25	25	32		T2005268
PWLNK 2525 M06	150	25	25	32		T2005269

ACCESSORIES PAGE 74 - 79

* Tool holders and accessories on request

EXTERNAL TURNING TOOL HOLDERS

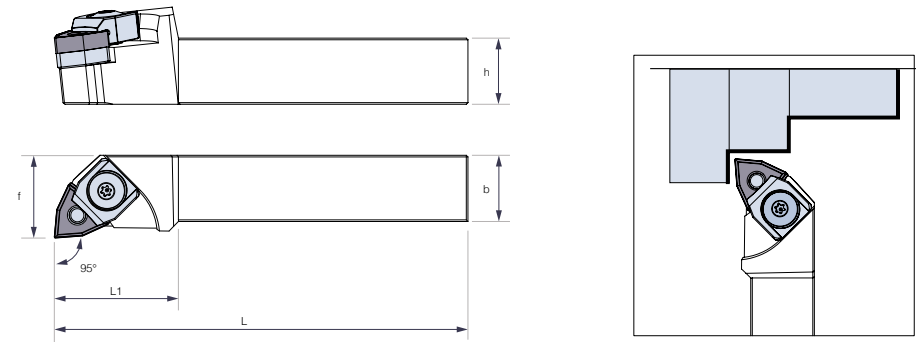

DESIGNATION	L	H	B	F	INSERT	CATALOG #
MWLNK 2020 K08	125	20	20	25	WN.. 0804	T2005172
MWLNK 2020 K08	125	20	20	25		T2005156
MWLNK 2525 M08	150	25	25	32		T2005260
MWLNK 2525 M08	150	25	25	32		T2005259
MWLNK 3232 P08	170	32	32	40		T2005258
MWLNK 3232 P08	170	32	32	40		T2005257

ACCESSORIES PAGE 74 - 79

* Tool holders and accessories on request

INTERNAL TURNING TOOL HOLDERS

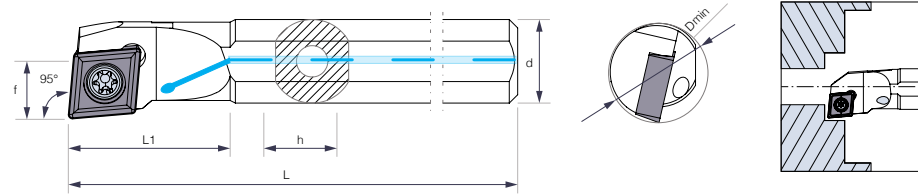

DESIGNATION	Dmin	d (mm)	L (mm)	L1 (mm)	f (mm)	h (mm)	INSERT	CATALOG #
A08H SCLCR 06	11	8	100	17	5	7	CC.. 0602	T2005368
A08H SCLCL 06	11	8	100	17	5	7		T2005369
A10J SCLCR 06	14	10	110	20	6	7		T2005370
A10J SCLCL 06	14	10	110	20	6	7		T2005371
A12K SCLCR 06	17	12	125	22	9	11		T2005372
A12K SCLCL 06	17	12	125	22	9	11		T2005373

ACCESSORIES PAGE 74 - 79

* Tool holders and accessories on request

DESIGNATION	Dmin	d (mm)	L (mm)	L1 (mm)	f (mm)	h (mm)	INSERT	CATALOG #
A16Q SCLCR 09	20	16	180	30	11	15	CC.. 09T3	T2005374
A16Q SCLCL 09	20	16	180	30	11	15		T2005375
A20Q SCLCR 09	25	20	180	38	13	19		T2005376
A20Q SCLCL 09	25	20	180	38	13	19		T2005377

ACCESSORIES PAGE 74 - 79

* Tool holders and accessories on request

DESIGNATION	Dmin	d (mm)	L (mm)	L1 (mm)	f (mm)	h (mm)	INSERT	CATALOG #
A25R SCLCR 12		25	200				CC.. 1204	T2005378
A25R SCLCL 12		25	200					T2005379

ACCESSORIES PAGE 74 - 79

* Tool holders and accessories on request

INTERNAL TURNING TOOL HOLDERS

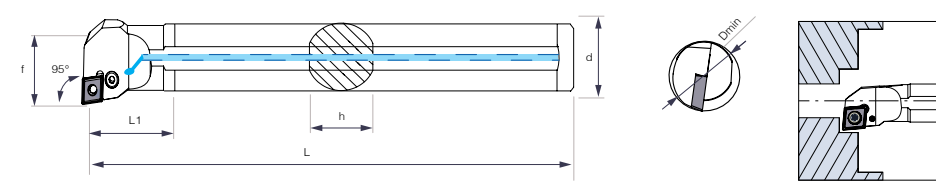

DESIGNATION	Dmin	d (mm)	L (mm)	L1 (mm)	f (mm)	h (mm)	INSERT	CATALOG #
A25S PCLNR 12	32	25	250	50	17	23	CN.. 1204	T2005380
A25S PCLNL 12	32	25	250	50	17	23		T2005381
A32T PCLNR 12	40	32	300	50	22	30		T2005382
A32T PCLNL 12	40	32	300	50	22	30		T2005383

ACCESSORIES PAGE 74 - 79

* Tool holders and accessories on request

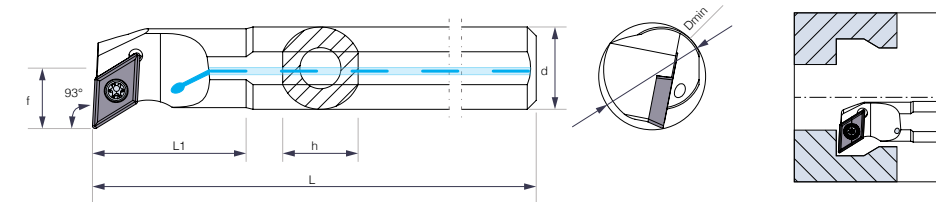

DESIGNATION	Dmin	d (mm)	L (mm)	L1 (mm)	f (mm)	h (mm)	INSERT	CATALOG #
A10J SDUCR 07	14	10	110	20	7	9	DC.. 0702	T2005384
A10J SDUCL 07	14	10	110	20	7	9		T2005385
A12K SDUCR 07	17	12	125	24	9	11		T2005386
A12K SDUCL 07	17	12	125	24	9	11		T2005387

ACCESSORIES PAGE 74 - 79

* Tool holders and accessories on request

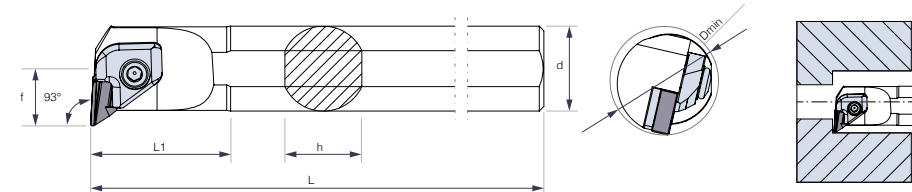
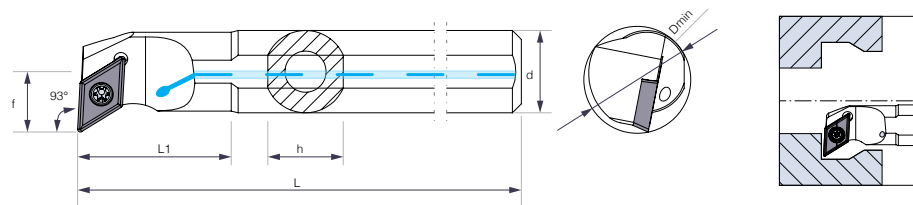

DESIGNATION	Dmin	d (mm)	L (mm)	L1 (mm)	f (mm)	h (mm)	INSERT	CATALOG #
A16Q SDUCR 11	21	16	180	30	11	15	DC.. 11T3	T2005388
A16Q SDUCL 11	21	16	180	30	11	15		T2005389
A20Q SDUCR 11	25	20	180	32	13	18		T2005390
A20Q SDUCL 11	25	20	180	32	13	18		T2005391
A25R SDUCR 11	32	25	200	40	17	23		T2005392
A25R SDUCL 11	32	25	200	40	17	23		T2005393

ACCESSORIES PAGE 74 - 79

* Tool holders and accessories on request

DESIGNATION	Dmin	d (mm)	L (mm)	L1 (mm)	f (mm)	h (mm)	INSERT	CATALOG #
S25S CKUNR 16	32	25	300	52	20	23	KNUX 1604	T2005398
S32U CKUNR 16	32	25	300	52	20	23		T2005399

ACCESSORIES PAGE 74 - 79

* Tool holders and accessories on request

DESIGNATION	Dmin	d (mm)	L (mm)	L1 (mm)	f (mm)	h (mm)	INSERT	CATALOG #
S25S PSKNR 12		25	250				SN.. 1204	T2005400
S25S PSKNL 12		25	250					T2005401
S32T PSKNR 12		32	300					T2005402
S32T PSKNL 12		32	300					T2005403

ACCESSORIES PAGE 74 - 79

* Tool holders and accessories on request

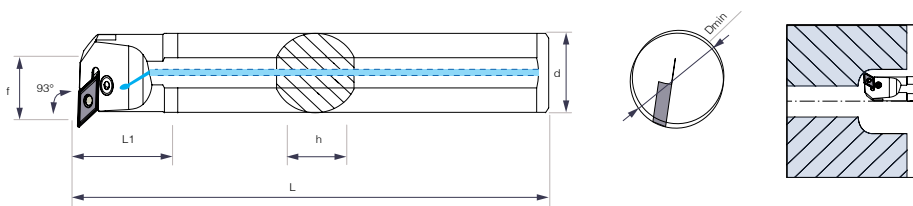

DESIGNATION	Dmin	d (mm)	L (mm)	L1 (mm)	f (mm)	h (mm)	INSERT	CATALOG #
A25S PDUNR 15	32	25	250	50	17	23	DN.. 1506	T2005394
A25S PDUNL 15	32	25	250	50	17	23		T2005395
A32T PDUNR 15	40	32	300	55	22	30		T2005396
A32T PDUNL 15	40	32	300	55	22	30		T2005397

ACCESSORIES PAGE 74 - 79

* Tool holders and accessories on request

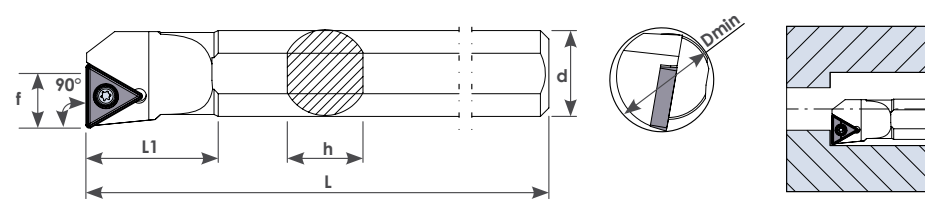

DESIGNATION	Dmin	d (mm)	L (mm)	L1 (mm)	f (mm)	h (mm)	INSERT	CATALOG #
S12K STFCR 11	17	12	125	24	9	11	TC.. 1102	T2005404
S12Q STFCL 11	17	12	125	24	9	11		T2005405
S16Q STFCR 11	21	16	180	30	11	15		T2005406
S16Q STFCL 11	21	16	180	30	11	15		T2005407

ACCESSORIES PAGE 74 - 79

* Tool holders and accessories on request

DESIGNATION	Dmin	d (mm)	L (mm)	L1 (mm)	f (mm)	h (mm)	INSERT	CATALOG #
S16Q STFCR 16	21	16	180	30	11	15	TC.. 16T3	T2005408
S16Q STFCL 16	21	16	180	30	11	15		T2005409
S20Q STFCR 16	25	20	180	30	13	18		T2005410
S20Q STFCL 16	25	20	180	30	13	18		T2005411
S25R STFCR 16	32	25	200	37	16	23		T2005412
S25R STFCL 16	32	25	200	37	16	23		T2005413

ACCESSORIES PAGE 74 - 79

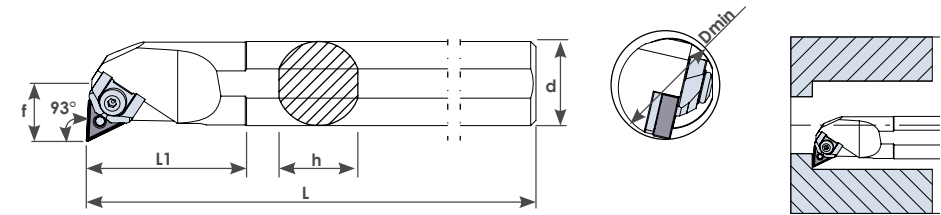

DESIGNATION	Dmin	d (mm)	L (mm)	L1 (mm)	f (mm)	h (mm)	INSERT	CATALOG #
S20R MTUNR 16	26	20	200	30	13	18	TN.. 1604	T2005414
S20R MTUNL 16	26	20	200	30	13	18		T2005415
S25S MTUNR 16	32	25	250	50	17	23		T2005416
S25S MTUNL 16	32	25	250	50	17	23		T2005417
S32T MTUNR 16	40	32	300	60	22	30		T2005418
S32T MTUNL 16	40	32	300	60	22	30		T2005419

ACCESSORIES PAGE 74 - 79

DESIGNATION	Dmin	d (mm)	L (mm)	L1 (mm)	f (mm)	h (mm)	INSERT	CATALOG #
S32T MTUNR 22	40	32	300	60	22	30	TN.. 2204	T2005420
S32T MTUNL 22	40	32	300	60	22	30		T2005421
S40T MTUNR 22	50	40	300	60	27	38		T2005422
S40T MTUNL 22	50	40	300	60	27	38		T2005423

ACCESSORIES PAGE 74 - 79

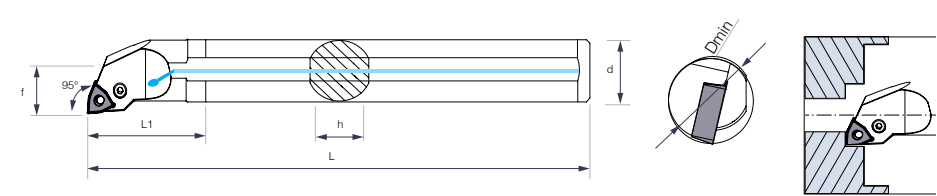
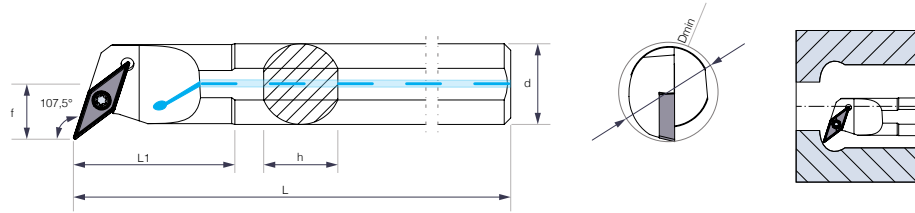

DESIGNATION	Dmin	d (mm)	L (mm)	L1 (mm)	f (mm)	h (mm)	INSERT	CATALOG #
A16Q SVQBR 11	21	16	180	30	11	15	VB.. 1103	T2005424
A16Q SVQBL 11	21	16	180	30	11	15		T2005425
A20Q SVQBR 11	25	20	180	30	13	18		T2005426
A20Q SVQBL 11	25	20	180	30	13	18		T2005427

ACCESSORIES PAGE 74 - 79

DESIGNATION	Dmin	d (mm)	L (mm)	L1 (mm)	f (mm)	h (mm)	INSERT	CATALOG #
A20R PWLNR 06	25	20	180	40	13	18	WN.. 0604	T2005432
A20R PWLNL 06	25	20	180	40	13	18		T2005433
A25R PWLNR 06		25	200					T2005434
A25R PWLNL 06		25	200					T2005435

ACCESSORIES PAGE 74 - 79

* Tool holders and accessories on request

DESIGNATION	Dmin	d (mm)	L (mm)	L1 (mm)	f (mm)	h (mm)	INSERT	CATALOG #
A25R SVQBR 16		25	200				VB.. 1604	T2005428
A25R SVQBL 16		25	200					T2005429

ACCESSORIES PAGE 74 - 79

DESIGNATION	Dmin	d (mm)	L (mm)	L1 (mm)	f (mm)	h (mm)	INSERT	CATALOG #
A25S PWLNR 08	32	25	250	50	17	23	WN.. 0804	T2005436
A25S PWLNL 08	32	25	250	50	17	23		T2005437
A32T PWLNR 08	40	32	300	60	22	30		T2005438
A32T PWLNL 08	40	32	300	60	22	30		T2005439

ACCESSORIES PAGE 74 - 79

* Tool holders and accessories on request

DESIGNATION	Dmin	d (mm)	L (mm)	L1 (mm)	f (mm)	h (mm)	INSERT	CATALOG #
A25R SVQCR 16		25	200				VC.. 1604	T2005430
A25R SVQCL 16		25	200					T2005431

ACCESSORIES PAGE 74 - 79

* Tool holders and accessories on request

ACCESSORIES - EXTERNAL TURNING TOOL HOLDERS

* Tool holders and accessories on request

DESIGNATION	ACCESSORIES												
	SHIM	CLAMP SCREW	LEVER PLATE	LEVER	SHIM SCREW	CLAMP	PIN	LOCKING SCREW	ALLEN KEY	TORKX KEY	LOCKING SCREW	SPRING	WASHER
SCLCR 1010 J06		T2005533								M2002915			
SCLCL 1010 J06		T2005533								M2002915			
SCLCR 1212 J09	T2005440	T2005535								M2000602			
SCLCL 1212 J09	T2005440	T2005535								M2000602			
SCLCR 1616 H09	T2005440	T2005535								M2000602	T2005493		
SCLCL 1616 H09	T2005440	T2005535								M2000602	T2005493		
SCLCR 2020 K09	T2005440	T2005535								M2000602	T2005493		
SCLCL 2020 K09	T2005440	T2005535								M2000602	T2005493		
SCLCR 2020 K12		T2005494								M2000602	T2005523		
SCLCL 2020 K12		T2005494								M2000602	T2005523		
SCLCR 2525 M12		T2005494								M2000602	T2005523		
SCLCL 2525 M12		T2005494								M2000602	T2005523		
DCLNR 2020 K12	T2005476				T2005536	T2005515		T2005495	M2000609			T2005483	T2005496
DCLNL 2020 K12	T2005476				T2005536	T2005515		T2005495	M2000609			T2005483	T2005496
DCLNR 2525 M12	T2005476				T2005536	T2005515		T2005495	M2000609			T2005483	T2005496
DCLNL 2525 M12	T2005476				T2005536	T2005515		T2005495	M2000609			T2005483	T2005496
DCLNR 3232 P12	T2005476				T2005536	T2005515		T2005495	M2000609			T2005483	T2005496
DCLNL 3232 P12	T2005476				T2005536	T2005515		T2005495	M2000609			T2005483	T2005496
PCLNR 1616 H12	T2005484	T2005527	T2005529	T2005511						M2002913			
PCLNL 1616 H12	T2005484	T2005527	T2005529	T2005511						M2002913			
PCLNR 2020 K12	T2005484	T2005528	T2005529	T2005511						M2002913			
PCLNL 2020 K12	T2005484	T2005528	T2005529	T2005511						M2002913			
PCLNR 2525 M12	T2005484	T2005528	T2005529	T2005511						M2002913			
PCLNL 2525 M12	T2005484	T2005528	T2005529	T2005511						M2002913			
SDJCR 1010 J07		T2005533								M2002915			
SDJCL 1010 J07		T2005533								M2002915			
SDJCR 1212 J07		T2005533								M2002915			
SDJCL 1212 J07		T2005533								M2002915			
SDJCR 1616 H07		T2005533								M2002915			
SDJCR 1616 H07		T2005533								M2002915			
SDJCR 1616 H11	T2005485	T2005535								M2000602	T2005493		
SDJCL 1616 H11	T2005485	T2005535								M2000602	T2005493		
SDJCR 2020 K11	T2005485	T2005535								M2000602	T2005493		
SDJCL 2020 K11	T2005485	T2005535								M2000602	T2005493		
SDJCR 2525 M11	T2005485	T2005535								M2000602	T2005493		
SDJCL 2525 M11	T2005485	T2005535								M2000602	T2005493		

ACCESSORIES - EXTERNAL TURNING TOOL HOLDERS

* Tool holders and accessories on request

DESIGNATION	ACCESSORIES												
	SHIM	CLAMP SCREW	LEVER PLATE	LEVER	SHIM SCREW	CLAMP	PIN	LOCKING SCREW	ALLEN KEY	TORKX KEY	LOCKING SCREW	SPRING	WASHER
DDJNR 2020 K11	T2005485												
DDJNL 2020 K11	T2005485												
DDJNR 2525 M11	T2005485												
DDJNL 2525 M11	T2005485												
DDJNR 2020 K1504	T2005486												
DDJNL 2020 K1504	T2005486												
DDJNR 2525 M1504	T2005486												
DDJNL 2525 M1504	T2005486												
DDJNR 2020 K15	T2005486												
DDJNL 2020 K15	T2005486												
DDJNR 2525 M15	T2005486												
DDJNL 2525 M15	T2005486												
CKJNR 2020 K16	T2005488												
CKJNL 2020 K16	T2005487												
CKJNR 2525 M16	T2005488												
CKJNL 2525 M16	T2005487												
SRDCN 2020 K06		T2005500											
SRDCN 2525 M06		T2005500											
SRDCN 2020 K08		T2005500											
SRDCN 2525 M08		T2005500											
SRDCN 2020 K10		T2005503											
SRDCN 2525 M10		T2005503											
SRDCN 2020 K12		T2005503											
SRDCN 2525 M12		T2005503											
SSDCN 1616 H09		T2005533											
SSDCN 2020 K09		T2005533											
DSSNR 2020 K12		T2005495											
DSSNR 2525 M12		T2005495											
STJCR 1212 F11		T2005533											
STJCL 1212 F11		T2005533											
STJCR 1616 H11		T2005533											
STJCL 1616 H11		T2005533											
DDJNR 2020 K11	T2005485												
DDJNL 2020 K11	T2005485												
DDJNR 2525 M11	T2005485												
DDJNL 2525 M11	T2005485												
DDJNR 2020 K1504	T2005486												
DDJNL 2020 K1504	T2005486												
DDJNR 2525 M1504	T2005486												
DDJNL 2525 M1504	T2005486												
DDJNR 2020 K15	T2005486												
DDJNL 2020 K15	T2005486												
DDJNR 2525 M15	T2005486												
DDJNL 2525 M15	T2005486												
CKJNR 2020 K16	T2005488												
CKJNL 2020 K16	T2005487												
CKJNR 2525 M16	T2005488												
CKJNL 2525 M16	T2005487												
SRDCN 2020 K06		T2005500											
SRDCN 2525 M06		T2005500											
SRDCN 2020 K08		T2005500											
SRDCN 2525 M08		T2005500											
SRDCN 2020 K10		T2005503											
SRDCN 2525 M10		T2005503											
SRDCN 2020 K12		T2005503											
SRDCN 2525 M12		T2005503											
SSDCN 1616 H09		T2005533											
SSDCN 2020 K09		T2005533											
DSSNR 2020 K12		T2005495											
DSSNR 2525 M12		T2005495											
STJCR 1212 F11		T2005533											
STJCL 1212 F11		T2005533											
STJCR 1616 H11		T2005533											
STJCL 1616 H11		T2005533											

ACCESSORIES - EXTERNAL TURNING TOOL HOLDERS

* Tool holders and accessories on request

DESIGNATION	ACCESSORIES													
	SHIM	CLAMP SCREW	LEVER PLATE	LEVER	SHIM SCREW	CLAMP	PIN	LOCKING SCREW	ALLEN KEY	TORKX KEY	LOCKING SCREW	SPRING	WASHER	
STJCR 1616 H16		T2005533								M2002915				
STJCL 1616 H16		T2005533								M2002915				
STJCR 2020 K16		T2005533								M2002915				
STJCL 2020 K16		T2005533								M2002915				
STJCR 2525 M16		T2005533								M2002915				
STJCR 2525 M16		T2005533								M2002915				
MTJNR 2020 K16					T2005517	T2005530	T2005492	M2002913			T2005482	T2005497		
MTJNL 2020 K16					T2005517	T2005530	T2005492	M2002913			T2005482	T2005497		
MTJNR 2525 M16					T2005517	T2005530	T2005492	M2002913			T2005482	T2005497		
MTJNL 2525 M16					T2005517	T2005530	T2005492	M2002913			T2005482	T2005497		
MTJNR 3232 P16					T2005517	T2005530	T2005492	M2002913			T2005482	T2005497		
MTJNL 3232 P16					T2005517	T2005530	T2005492	M2002913			T2005482	T2005497		
MTJNR 2525 M22					T2005518	T2005531	T2005495	M2000609			T2005483	T2005496		
MTJNL 2525 M22					T2005518	T2005531	T2005495	M2000609			T2005483	T2005496		
MTJNR 3232 P22					T2005518	T2005531	T2005495	M2000609			T2005483	T2005496		
MTJNL 3232 P22					T2005518	T2005531	T2005495	M2000609			T2005483	T2005496		
SVJBR 1212 J11		T2005499								M2002915				
SVJBL 1212 J11		T2005499								M2002915				
SVJBR 1616 H11		T2005499								M2002915				
SVJBL 1616 H11		T2005499								M2002915				
SVJBR 2020 K11		T2005499								M2002915				
SVJBL 2020 K11		T2005499								M2002915				
SVJBR 1616 H16		T2005502			T2005505					M2000602				
SVJBL 1616 H16		T2005502			T2005505					M2000602				
SVJBR 2020 K16		T2005502			T2005505					M2000602				
SVJBL 2020 K16		T2005502			T2005505					M2000602				
SVJBR 2525 M16		T2005502			T2005505					M2000602				
SVJBL 2525 M16		T2005502			T2005505					M2000602				
SVJCR 2020 K16		T2005502			T2005505					M2000602				
SVJCL 2020 K16		T2005502			T2005505					M2000602				
SVJCR 2525 M16		T2005502			T2005505					M2000602				
SVJCL 2525 M16		T2005502			T2005505					M2000602				
DVJNR 2020 K16					T2005504	T2005519		T2005492	M2002913		T2005482	T2005498		
DVJNL 2020 K16					T2005504	T2005519		T2005492	M2002913		T2005482	T2005498		
DVJNR 2525 M16					T2005504	T2005519		T2005492	M2002913		T2005482	T2005498		
DVJNL 2525 M16					T2005504	T2005519		T2005492	M2002913		T2005482	T2005498		

ACCESSORIES - EXTERNAL TURNING TOOL HOLDERS

* Tool holders and accessories on request

DESIGNATION	ACCESSORIES													
	SHIM	CLAMP SCREW	LEVER PLATE	LEVER	SHIM SCREW	CLAMP	PIN	LOCKING SCREW	ALLEN KEY	TORKX KEY	LOCKING SCREW	SPRING	WASHER	
PWLNR 2020 K06		T2005526	T2005521	T2005510									M2002914	
PWLNL 2020 K06		T2005526	T2005521	T2005510									M2002914	
PWLNR 2525 M06		T2005526	T2005521	T2005510									M2002914	
PWLNL 2525 M06		T2005526	T2005521	T2005510									M2002914	
MWLNR 2020 K08					T2005520	T2005531	T2005495	M2000609						
MWLNL 2020 K08					T2005520	T2005531	T2005495	M2000609						
MWLNR 2525 M08					T2005520	T2005531	T2005495	M2000609						
MWLNL 2525 M08					T2005520	T2005531	T2005495	M2000609						
MWLNR 3232 P08					T2005520	T2005531	T2005495	M2000609						
MWLNL 3232 P08					T2005520	T2005531	T2005495	M2000609						

ACCESSORIES - INTERNAL TURNING TOOL HOLDERS

* Tool holders and accessories on request

DESIGNATION	ACCESSORIES										
	TORKX SCREW	SHIM	CLAMP SCREW	LEVER	PIN	PLATE	SHIM SCREW	KEY	CLAMP	SPRING	WASHER
A08H SCLCR 06	T2005533							M2002915			
A08H SCLCL 06	T2005533							M2002915			
A10J SCLCR 06	T2005533							M2002915			
A10J SCLCL 06	T2005533							M2002915			
A12K SCLCR 06	T2005533							M2002915			
A12K SCLCL 06	T2005533							M2002915			
A16Q SCLCR 09	T2005534							M2000602			
A16Q SCLCL 09	T2005534							M2000602			
A20Q SCLCR 09	T2005534							M2000602			
A20Q SCLCL 09	T2005534							M2000602			
A25R SCLCR 12	T2005534							M2000602			
A25R SCLCL 12	T2005534							M2000602			
A25S PCLNR 12			T2005525	T2005512				M2002914			
A25S PCLNL 12			T2005525	T2005512				M2002914			
A32T PCLNR 12		T2005484	T2005525	T2005512		T2005529		M2002913			
A32T PCLNL 12		T2005484	T2005525	T2005512		T2005529		M2002913			
A10J SDUCR 07	T2005533							M2002915			
A10J SDUCL 07	T2005533							M2002915			
A12K SDUCR 07	T2005533							M2002915			
A12K SDUCL 07	T2005533							M2002915			
A16Q SDUCR 11	T2005534							M2000602			
A16Q SDUCL 11	T2005534							M2000602			
A20Q SDUCR 11	T2005534							M2000602			
A20Q SDUCL 11	T2005534							M2000602			
A25R SDUCR 11	T2005534							M2000602			
A25R SDUCL 11	T2005534							M2000602			
A25S PDUNR 15			T2005525	T2005512				M2002914			
A25S PDUNL 15			T2005525	T2005512				M2002914			
A32T PDUNR 15		T2005484	T2005506	T2005513		T2005529		M2002913			
A32T PDUNL 15		T2005484	T2005506	T2005513		T2005529		M2002913			
S25S CKUNR 16									T2005516		
S32U CKUNR 16									T2005516		
S25S PSKNR 12			T2005525	T2005512				M2002914			
S25S PSKNL 12			T2005525	T2005512				M2002914			
S32T PSKNR 12			T2005528	T2005511		T2005529		M2002913			
S32T PSKNL 12			T2005528	T2005511		T2005529		M2002913			

ACCESSORIES - INTERNAL TURNING TOOL HOLDERS

* Tool holders and accessories on request

DESIGNATION	ACCESSORIES										
	TORKX SCREW	SHIM	CLAMP SCREW	LEVER	PIN	PLATE	SHIM SCREW	KEY	CLAMP	SPRING	WASHER
S12K STFCR 11	T2005533							M2002915			
S12Q STFCL 11	T2005533							M2002915			
S16Q STFCR 11	T2005533							M2002915			
S16Q STFCL 11	T2005533							M2002915			
S16Q STFCR 16	T2005533							M2000602			
S16Q STFCL 16	T2005533							M2000602			
S20Q STFCR 16	T2005533							M2000602			
S20Q STFCL 16	T2005533							M2000602			
S25R STFCR 16	T2005533							M2000602			
S25R STFCL 16	T2005533							M2000602			
S20R MTUNR 16	T2005492	T2005489			T2005530			M2002913	T2005517	T2005482	T2005497
S20R MTUNL 16	T2005492	T2005489			T2005530			M2002913	T2005517	T2005482	T2005497
S25S MTUNR 16	T2005492	T2005489			T2005530			M2002913	T2005517	T2005482	T2005497
S25S MTUNL 16	T2005492	T2005489			T2005530			M2002913	T2005517	T2005482	T2005497
S32T MTUNR 16	T2005492	T2005489			T2005530			M2002913	T2005517	T2005482	T2005497
S32T MTUNL 16	T2005492	T2005489			T2005530			M2002913	T2005517	T2005482	T2005497
S32T MTUNR 22	T2005495	T2005490			T2005531			M2000609	T2005518	T2005483	T2005497
S32T MTUNL 22	T2005495	T2005490			T2005531			M2000609	T2005518	T2005483	T2005497
S40T MTUNR 22	T2005495	T2005490			T2005531			M2000609	T2005518	T2005483	T2005497
S40T MTUNL 22	T2005495	T2005490			T2005531			M2000609	T2005518	T2005483	T2005497
A16Q SVQBR 11	T2005532							M2002915			
A16Q SVQBL 11	T2005532							M2002915			
A20Q SVQBR 11	T2005532							M2002915			
A20Q SVQBL 11	T2005532							M2002915			
A25R SVQBR 16	T2005522							M2000602			
A25R SVQBL 16	T2005522							M2000602			
A25R SVQCR 16	T2005522							M2000602			
A25R SVQCL 16	T2005522							M2000602			
A20R PWLNR 06			T2005524	T2005509				M2002916			
A20R PWLNL 06			T2005524	T2005509				M2002916			
A25R PWLNR 06			T2005524	T2005509				M2002916			
A25R PWLNL 06			T2005524	T2005509				M2002916			
A25S PWLNR 08			T2005525	T2005512				M2002914			
A25S PWLNL 08			T2005525	T2005512				M2002914			
A32T PWLNR 08		T2005480	T2005528	T2005511		T2005529		M2002913			
A32T PWLNL 08		T2005480	T2005528	T2005511		T2005529		M2002913			

**With Lamina you
have the right tool,
at the right time, all
the time**



PARTING & GROOVING

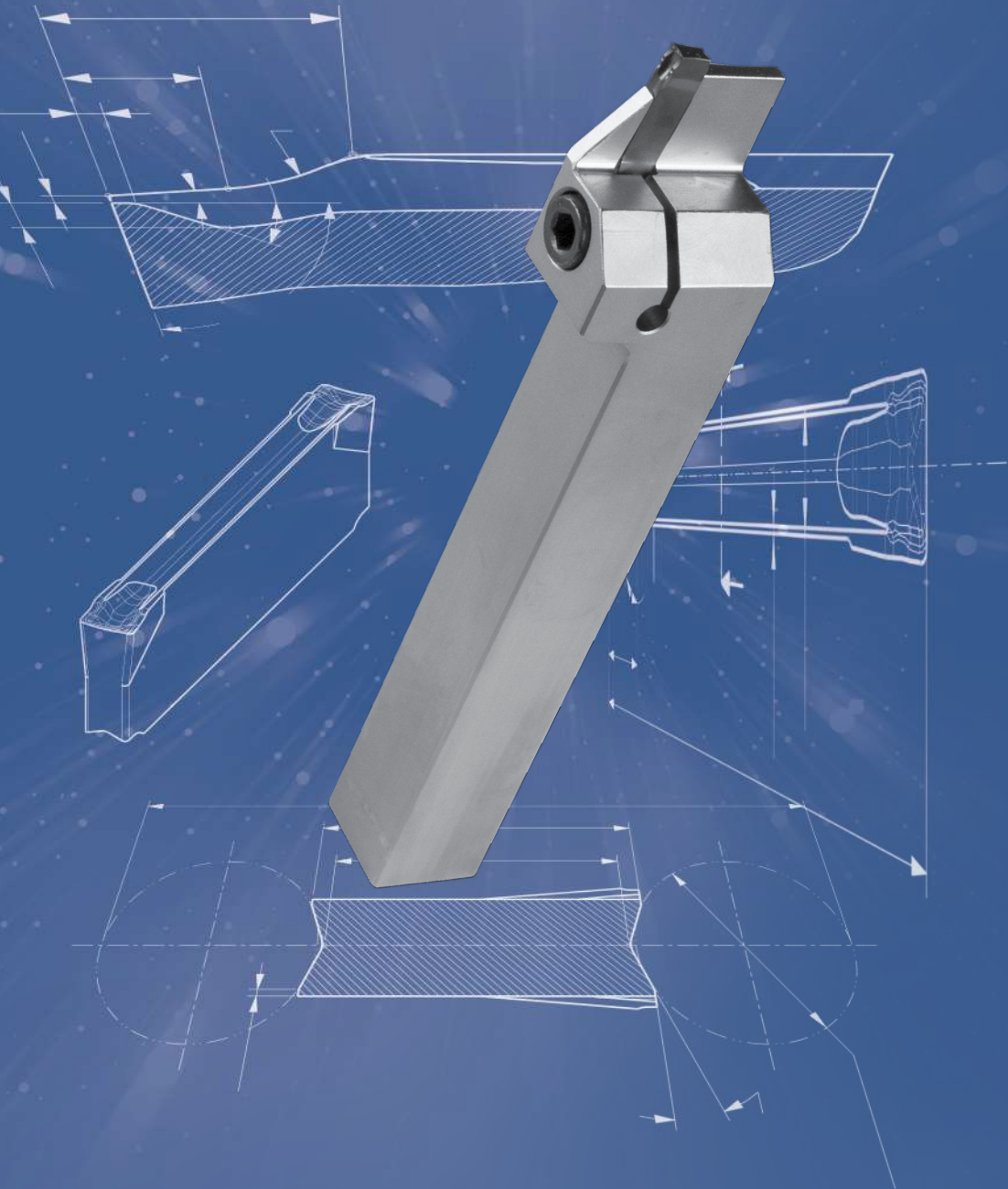

PARTING AND GROOVING

MULTI-MAT™ PARTING INSERTS AND TOOLS FOR MULTIPLE APPLICATIONS

Our Swiss quality, precision made parting and grooving inserts are designed for efficient and trouble free application in a wide variety of materials.

- Universal grade for long tool life in numerous workpiece materials
- ISO standard blocks and blades

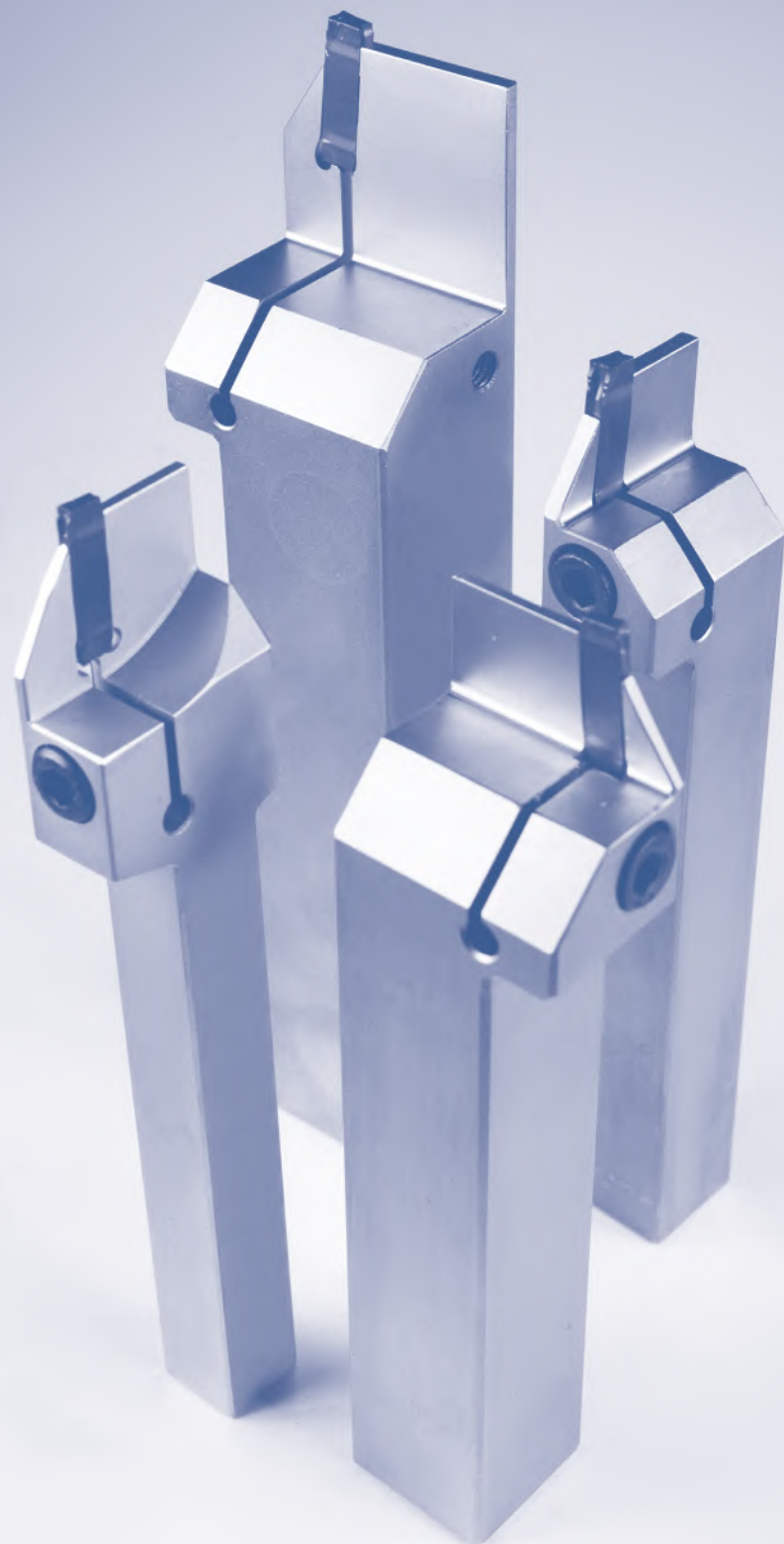

GCTX



MAGIA

DESIGNATION	GRADE	W	R	MATERIAL RECOMMENDATION	CATALOG #
GCTX 2002 NN	LT 1000	2.00	0.18		T0002825
GCTX 3003 NN	LT 1000	3.00	0.25		T0002826
GCTX 3003 PP	LT 1000	3.00	0.25		T0002828

M G M N



ALPHA

DESIGNATION	GRADE	W	R	MATERIAL RECOMMENDATION	CATALOG #
MGMN 200 G	LT 10	2.00	0.2		T0003909
MGMN 300 M	LT 10	3.00	0.4		T0003910
MGMN 400 M	LT 10	4.00	0.4		T0003911
MGMN 500 M	LT 10	5.00	0.8		T0003921

W G E



ALPHA

DESIGNATION	GRADE	W	R	MATERIAL RECOMMENDATION	CATALOG #
WGE 2000	LT 10	2.00	0.2		T0003932
WGE 3000	LT 10	3.00	0.2		T0003933
WGE 4000	LT 10	4.00	0.2		T0003934
WGE 5000	LT 10	5.00	0.2		T0003935

PARTING AND GROOVING TOOL HOLDERS

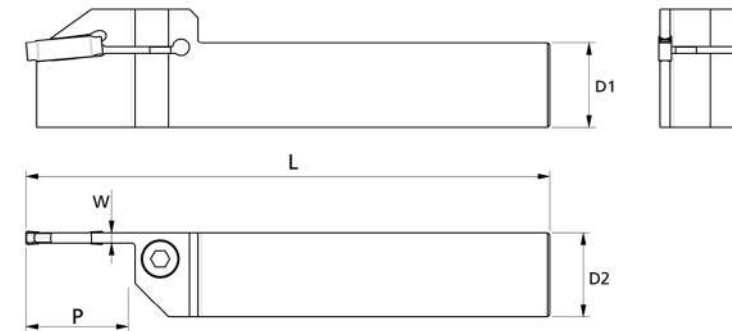

GCTX 2002

DESIGNATION	D	D2	L	W	Pmax	HAND	CATALOG #
LT PNG-L 12-2.0	12	12	120	1.6	15	LEFT	T2001164
LT PNG-R 12-2.0	12	12	120	1.6	15	RIGHT	T2001165
LT PNG-L 16-2.0	16	16	120	1.6	15	LEFT	T2001166
LT PNG-R 16-2.0	16	16	120	1.6	15	RIGHT	T2001167
LT PNG-L 20-2.0	20	20	120	1.6	15	LEFT	T2001484
LT PNG-R 20-2.0	20	20	120	1.6	15	RIGHT	T2001485
LT PNG-L 25-2.0	25	25	120	1.6	15	LEFT	T2001482
LT PNG-R 25-2.0	25	25	120	1.6	15	RIGHT	T2001483

SCREW M2001797
KEY M2000609

GCTX 3003

DESIGNATION	D	Dmin	L	W	Pmax	HAND	CATALOG #
LT PNG-L 16-3.0	16	16	120	2.4	15	LEFT	T2001168
LT PNG-R 16-3.0	16	16	120	2.4	15	RIGHT	T2001169
LT PNG-L 20-3.0	20	20	125	2.4	15	LEFT	T2001170
LT PNG-R 20-3.0	20	20	125	2.4	15	RIGHT	T2001171
LT PNG-L 25-3.0	25	25	125	2.4	15	LEFT	T2001197
LT PNG-R 25-3.0	25	25	125	2.4	15	RIGHT	T2001198

SCREW M2001797
KEY M2000609

BLADES AND BLOCKS

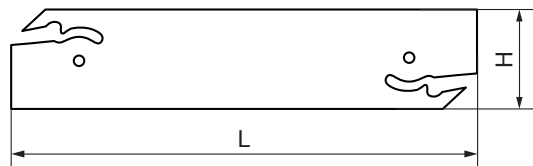

GCTX 3003

DESIGNATION	L	H	-	-	-	-	CATALOG #
LT BNG-32-3	32	32	-	-	-	-	T2002751

KEY T2002761

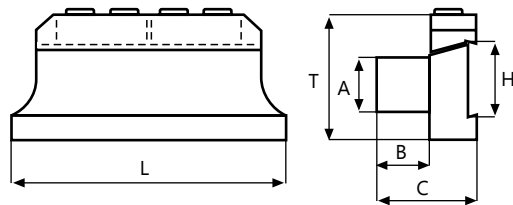

BLOCKS

DESIGNATION	H	A	B	C	L	T	CATALOG #
LT PNB-N 2020-32	32	20	19	38	120	48	T2002762
LT PNB-N 2525-32	32	25	23	42	120	48	T2002763

SCREW T2002785
KEY T2002786

CUTTING DATA



p. 253 - 256

THREAD TURNING



THREAD TURNING

MULTI-MAT™ INTERNAL AND EXTERNAL THREADING INSERTS

Our threading inserts offer superior tool life and versatility in a range of materials.

We offer a broad selection of triangular thread turning inserts and tool-holders for external and internal threads and a variety of thread standards.

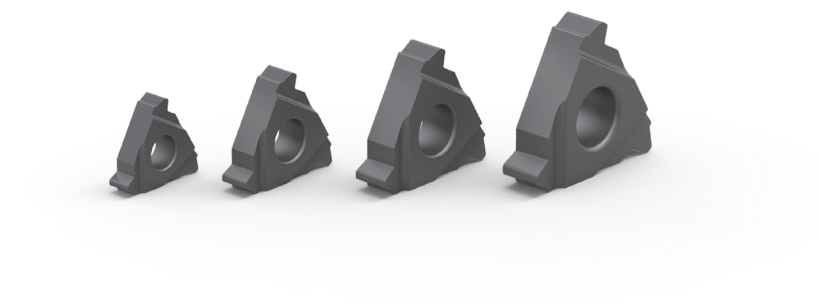

CUTTING DATA

 p. 339 - 342

TECHNICAL SECTION

 p. 360 - 365

INSERT ORDERING CODE

ISO	0.5	ER	16			
PROFILE	PITCH		TYPE OF INSERT	INSERT SIZE		
PARTIAL PROFILE 60°, 55°	SHAPE	mm	TPI	ER External right handed	L	I.C.
		A	0.5 - 1.5		48 - 16	06
FULL PROFILE ISO METRIC, BSPT, NPT, UN, TRAPEZ, WITHWORTH	Full Profile	G	1.75 - 3.0	14 - 8	08	5.0
		AG	0.5 - 3.0	48 - 8	11	6.3
		N	3.5 - 5.0	7 - 5	16	9.5
		Q	5.5 - 6.0	4.5 - 4	22	12.7
	-	3.5 - 6.0	72 - 4	IL Internal left handed	27	15.8

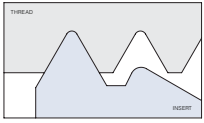
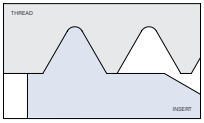
PARTIAL (A,G,AG,N,Q)	FULL
 <ul style="list-style-type: none"> • Most economical solution • Used for wide range of pitches • It is partial because the exterior major or internal minor diameter is not machined 	 <ul style="list-style-type: none"> • Cuts all thread shapes according to the requirements • Wide range of inserts needed in order to fit each standard and range of pitches

TOOL HOLDER ORDERING CODE

HER	2525	M	16		
HOLDER TYPE	SHANK	TOOL LENGTH		INSERT SIZE	
HER External right handed	External Tool holders Square Shank:	H	100	L	I.C.
		K	125	06	4.0
HEL External left handed	8, 10, 12, 16, 20, 25, 32	L	140	08	5.0
		M	150	11	6.3
HIR Internal right handed	Internal Tool holders Round Shank:	P	170	16	9.5
		R	200	22	12.7
HIL Internal left handed	10, 12, 16, 20, 25, 32, 40	S	250	27	15.8
		T	300		

PARTIAL PROFILE 60°

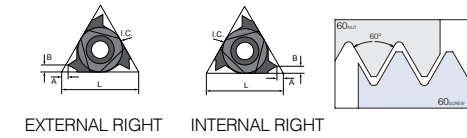

DESIGNATION	GRADE	PITCH RANGE		DIMENSIONS				CATALOG #
		mm	TPI	L mm	I.C.	A	B	
EXTERNAL								
A60 ER16	LT 10	0.5 - 1.5	48 - 16	16	9.5	0.8	0.9	TH000004
G60 ER16	LT 10	1.75 - 3.0	14 - 8	16	9.5	1.2	1.7	TH000010
AG60 ER16	LT 10	0.5 - 3.0	48 - 8	16	9.5	1.2	1.7	TH000016
N60 ER 22	LT 10	3.5 - 5.0	7 - 5	22	12.7	1.7	2.5	TH000116
INTERNAL								
A60 IR11	LT 10	0.5 - 1.5	48 - 16	11	6.3	0.8	0.9	TH000001
A60 IR16	LT 10	0.5 - 1.5	48 - 16	16	9.5	0.8	0.9	TH000007
G60 IR16	LT 10	1.75 - 3.0	14 - 8	16	9.5	1.2	1.7	TH000013
AG60 IR16	LT 10	0.5 - 3.0	48 - 8	16	9.5	1.2	1.7	TH000019
N60 IR 22	LT 10	3.5 - 5.0	7 - 5	22	12.7	1.7	2.5	TH000119

PARTIAL PROFILE 55°

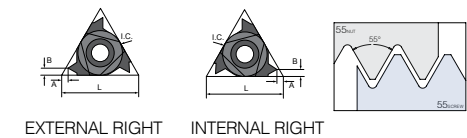

DESIGNATION	GRADE	PITCH RANGE		DIMENSIONS				CATALOG #
		mm	TPI	L mm	I.C.	A	B	
EXTERNAL								
A55 ER16	LT 10	0.5 - 1.5	48 - 8	16	9.5	0.8	0.9	TH000167
AG55 ER16	LT 10	0.5 - 3.0	48 - 8	16	9.5	1.2	1.7	TH000022
G55 ER16	LT 10	1.75 - 3.0	7 - 5	16	9.5	1.2	1.7	TH000168
N55 ER22	LT 10	3.5 - 5.0	7 - 5	22	12.7	1.7	2.5	TH000120
INTERNAL								
A55 IR16	LT 10	0.5 - 1.5	48 - 8	16	9.5	0.8	0.9	TH000183
AG55 IR16	LT 10	0.5 - 3.0	48 - 8	16	9.5	1.2	1.7	TH000025
G55 IR16	LT 10	1.75 - 3.0	7 - 5	16	9.5	1.2	1.7	TH000184
N55 IR22	LT 10	3.5 - 5.0	7 - 5	22	12.7	1.7	2.5	TH000121

BSPT

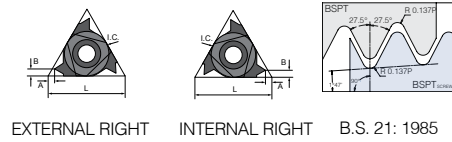

DESIGNATION	GRADE	TPI	DIMENSIONS				CATALOG #
			L mm	I.C.	A	B	
EXTERNAL							
BSPT11 ER16	LT 10	11	16	9.525	1.1	1.5	TH000138
BSPT14 ER16	LT 10	14	16	9.525	1.0	1.2	TH000137
BSPT19 ER16	LT 10	19	16	9.525	0.8	0.9	TH000136
INTERNAL							
BSPT11 IR16	LT 10	11	16	9.525	1.1	1.5	TH000141
BSPT14 IR16	LT 10	14	16	9.525	1.0	1.2	TH000140
BSPT19 IR16	LT 10	19	16	9.525	0.8	0.9	TH000139

NPT

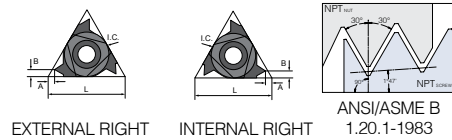

DESIGNATION	GRADE	TPI	DIMENSIONS				CATALOG #
			L mm	I.C.	A	B	
EXTERNAL							
NPT 8 ER16	LT 10	8	16	9.525	1.3	1.8	TH000145
NPT 11.5 ER16	LT 10	11.5	16	9.525	1.1	1.5	TH000144
NPT 14 ER16	LT 10	14	16	9.525	0.9	1.2	TH000143
NPT 18 ER16	LT 10	18	16	9.525	0.8	1.0	TH000142
INTERNAL							
NPT 8 IR16	LT 10	8	16	9.525	1.3	1.8	TH000148
NPT 11.5 IR16	LT 10	11.5	16	9.525	1.1	1.5	TH000147
NPT 14 IR16	LT 10	14	16	9.525	0.9	1.2	TH000146
NPT 27 IR16	LT 10	27	16	9.525	0.7	0.8	TH000181

UN

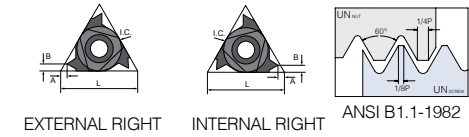

DESIGNATION	GRADE	TPI	DIMENSIONS				CATALOG #
			L mm	I.C.	A	B	
EXTERNAL							
UN 10 ER16	LT 10	10	16	9.525	1.1	1.5	TH000161
UN 12 ER16	LT 10	12	16	9.525	1.1	1.4	TH000088
UN 13 ER16	LT 10	13	16	9.525	1.0	1.3	TH000163
UN 16 ER16	LT 10	16	16	9.525	0.9	1.1	TH000082
UN 20 ER16	LT 10	20	16	9.525	0.8	0.9	TH000076
UN 24 ER16	LT 10	24	16	9.525	0.7	0.8	TH000165
UN 32 ER16	LT 10	32	16	9.525	0.6	0.6	TH000166
UN 5 ER22	LT 10	5	22	12.70	1.7	2.4	TH000186
UN 6 ER22	LT 10	6	22	12.70	1.6	2.3	TH000189
UN 7 ER22	LT 10	7	22	12.70	1.6	2.3	TH000190
INTERNAL							
UN 8 IR16	LT 10	8	16	9.525	1.2	1.6	TH000170
UN 9 IR16	LT 10	9	16	9.525	1.2	1.7	TH000171
UN 10 IR16	LT 10	10	16	9.525	1.1	1.5	TH000172
UN 11 IR16	LT 10	11	16	9.525	1.1	1.5	TH000173
UN 11.5 IR16	LT 10	11.5	16	9.525	1.1	1.5	TH000174
UN 12 IR16	LT 10	12	16	9.525	0.8	0.9	TH000091
UN 13 IR16	LT 10	13	16	9.525	1.0	1.3	TH000175
UN 16 IR16	LT 10	16	16	9.525	0.9	1.1	TH000085
UN 20 IR16	LT 10	20	16	9.525	1.1	1.4	TH000079
UN 32 IR16	LT 10	32	16	9.525	0.6	0.6	TH000182
UN 6 IR22	LT 10	6	22	12.70	1.6	2.3	TH000196
UN 7 IR22	LT 10	7	22	12.70	1.6	2.3	TH000198

TRAPEZ

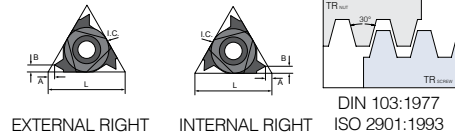

DESIGNATION	GRADE	PITCH mm	DIMENSIONS				CATALOG #
			L mm	I.C.	A	B	
EXTERNAL							
TR 2.0 ER16	LT 10	2.00	16	9.525	1.0	1.3	TH000160
TR 3.0 ER16	LT 10	3.00	16	9.525	1.3	1.5	TH000149
TR 5.0 ER22	LT 10	5.00	22	12.70	2.0	2.4	TH000185
TR 6.0 ER22	LT 10	6.00	22	12.70	2.0	2.4	TH000188
TR 4.0 ER22	LT 10	4.00	22	12.70	1.7	1.9	TH000150
INTERNAL							
TR 2.0 IR16	LT 10	2.00	16	9.525	1.0	1.3	TH000169
TR 3.0 IR16	LT 10	3.00	16	9.525	1.3	1.5	TH000151
TR 4.0 IR22	LT 10	4.00	22	12.70	1.7	1.9	TH000152
TR 5.0 IR22	LT 10	5.00	22	12.70	2.0	2.4	TH000194
TR 6.0 IR22	LT 10	6.00	22	12.70	2.0	2.4	TH000195

WHITWORTH

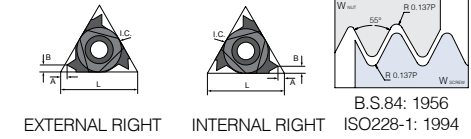

DESIGNATION	GRADE	TPI	DIMENSIONS				CATALOG #
			L mm	I.C.	A	B	
EXTERNAL							
W 10 ER16	LT 10	10	16	9.525	1.1	1.5	TH000162
W 11 ER16	LT 10	11	16	9.525	1.1	1.5	TH000100
W 14 ER16	LT 10	14	16	9.525	1.0	1.2	TH000094
W 16 ER16	LT 10	16	16	9.525	0.9	1.1	TH000164
W 19 ER16	LT 10	19	16	9.525	0.8	1.0	TH000134
W 5 ER22	LT 10	5	22	12.70	1.7	2.4	TH000187
W 7 ER22	LT 10	7	22	12.70	1.6	2.3	TH000191
INTERNAL							
W 11 IR16	LT 10	11	16	9.525	1.1	1.5	TH000103
W 14 IR16	LT 10	14	16	9.525	1.0	1.2	TH000097
W 16 IR16	LT 10	16	16	9.525	0.9	1.1	TH000176
W 18 IR16	LT 10	18	16	9.525	0.8	1.0	TH000177
W 19 IR16	LT 10	19	16	9.525	0.8	1.0	TH000135
W 20 IR16	LT 10	20	16	9.525	0.8	0.9	TH000178
W 24 IR16	LT 10	24	16	9.525	0.7	0.8	TH000179
W 26 IR16	LT 10	26	16	9.525	0.7	0.7	TH000180
W 6 IR22	LT 10	6	22	12.70	1.6	2.3	TH000197
W 7 IR22	LT 10	7	22	12.70	1.6	2.3	TH000199

ISO

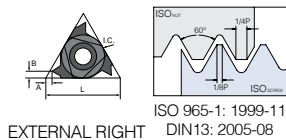

DESIGNATION	GRADE	PITCH mm	L mm	DIMENSIONS			CATALOG #
				I.C.	A	B	
EXTERNAL							
ISO 0.5 ER16	LT 10	0.5	16	9.525	0.6	0.6	TH000122
ISO 0.6 ER16	LT 10	0.6	16	9.525	0.6	0.6	TH000123
ISO 0.7 ER16	LT 10	0.7	16	9.525	0.6	0.6	TH000124
ISO 0.75 ER16	LT 10	0.75	16	9.525	0.6	0.6	TH000125
ISO 0.8 ER16	LT 10	0.8	16	9.525	0.6	0.6	TH000036
ISO 1.0 ER16	LT 10	1.0	16	9.525	0.6	0.7	TH000037
ISO 1.25 ER16	LT 10	1.25	16	9.525	0.8	0.9	TH000043
ISO 1.5 ER16	LT 10	1.5	16	9.525	0.8	1.0	TH000049
ISO 1.75 ER16	LT 10	1.75	16	9.525	0.9	1.2	TH000055
ISO 2.0 ER16	LT 10	2.0	16	9.525	1.0	1.3	TH000058
ISO 2.5 ER16	LT 10	2.5	16	9.525	1.1	1.5	TH000064
ISO 3.0 ER16	LT 10	3.0	16	9.525	1.1	1.5	TH000070
ISO 3.5 ER22	LT 10	3.5	22	12.70	1.6	2.3	TH000126
ISO 4.0 ER22	LT 10	4.0	22	12.70	1.6	1.5	TH000127
ISO 5.0 ER22	LT 10	5.0	22	12.70	1.6	1.3	TH000192
ISO 6.0 ER22	LT 10	6.0	22	12.70	1.6	2.4	TH000193

ISO

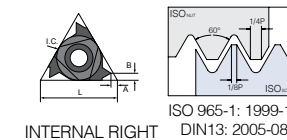

DESIGNATION	GRADE	PITCH mm	L mm	DIMENSIONS			CATALOG #
				I.C.	A	B	
INTERNAL							
ISO 1.0 IR11	LT 10	1.0	11	6.35	0.6	0.7	TH000028
ISO 1.5 IR11	LT 10	1.5	11	6.35	0.8	1.0	TH000031
ISO 2.0 IR11	LT 10	2.0	11	6.35	0.8	0.9	TH000034
ISO 0.5 IR16	LT 10	0.5	16	9.525	0.6	0.4	TH000128
ISO 0.6 IR16	LT 10	0.6	16	9.525	0.6	0.6	TH000129
ISO 0.7 IR16	LT 10	0.7	16	9.525	0.6	0.6	TH000130
ISO 0.75 IR16	LT 10	0.75	16	9.525	0.6	0.6	TH000131
ISO 0.8 IR16	LT 10	0.8	16	9.525	0.6	0.6	TH000132
ISO 1.0 IR16	LT 10	1.0	16	9.525	0.7	0.7	TH000040
ISO 1.25 IR16	LT 10	1.25	16	9.525	0.8	0.9	TH000046
ISO 1.5 IR16	LT 10	1.5	16	9.525	0.8	1.8	TH000052
ISO 1.75 IR16	LT 10	1.75	16	9.525	0.9	1.2	TH000056
ISO 2.0 IR16	LT 10	2.0	16	9.525	1.0	1.3	TH000061
ISO 2.5 IR16	LT 10	2.5	16	9.525	1.1	1.5	TH000067
ISO 3.0 IR16	LT 10	3.0	16	9.525	1.1	1.5	TH000073
ISO 3.5 IR22	LT 10	3.5	16	9.525	1.6	2.3	TH000200
ISO 4.0 IR22	LT 10	4.0	22	12.70	1.6	2.3	TH000133
ISO 4.5 IR22	LT 10	4.5	22	12.70	1.6	2.4	TH000201
ISO 5.0 IR22	LT 10	5.0	22	12.70	1.6	2.3	TH000202
ISO 5.5 IR22	LT 10	5.5	22	12.70	1.6	2.3	TH000203
ISO 6.0 IR22	LT 10	6.0	22	12.70	1.6	2.4	TH000204

ISO

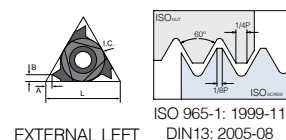

DESIGNATION	GRADE	PITCH mm	L mm	DIMENSIONS			CATALOG #
				I.C.	A	B	
EXTERNAL							
ISO 1.0 EL16	LT 10	1.0	16	9.525	0.7	0.7	TH000210
ISO 1.25 EL16	LT 10	1.25	16	9.525	0.8	0.9	TH000212
ISO 1.5 EL16	LT 10	1.5	16	9.525	0.8	1.0	TH000158
ISO 2.0 EL16	LT 10	2.0	16	9.525	1.0	1.3	TH000206
ISO 2.5 EL16	LT 10	2.5	16	9.525	1.1	1.5	TH000208

ISO

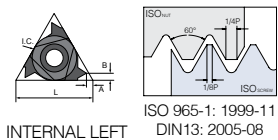

INTERNAL LEFT

ISO 965-1: 1999-11
DIN13: 2005-08

DESIGNATION	GRADE	PITCH mm	DIMENSIONS				CATALOG #
			L mm	I.C.	A	B	
INTERNAL							
ISO 1.0 IL11	LT 10	1.0	11	6.35	0.6	0.7	TH000211
ISO 1.25 IL11	LT 10	1.5	11	6.35	0.8	0.8	TH000213
ISO 1.5 IL16	LT 10	1.5	16	9.525	0.8	1.0	TH000159
ISO 1.75 IL16	LT 10	1.75	16	9.525	0.9	1.2	TH000205
ISO 2.0 IL16	LT 10	2.0	16	9.525	1.0	1.3	TH000207
ISO 2.5 IL16	LT 10	2.5	16	9.525	1.1	1.5	TH000209

THREADING TOOL HOLDERS

EXTERNAL RIGHT HANDED TOOL HOLDERS

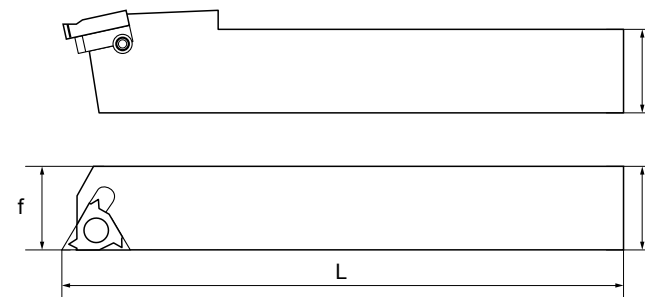

DESIGNATION	TYPE	H	B	F	L	CATALOG #
HEL2020K16	EL 16	20	20	20	125	TH200005
HEL2525M16	EL 16	25	25	25	150	TH200008
HER1616H16	ER 16	16	16	16	100	TH200001
HER2020K16	ER 16	20	20	20	125	TH200004
HER2525M16	ER 16	25	25	25	150	TH200007

* Accessories on request

INSERT SCREW TH290008
SHIM SCREW TH290021
KEY M2002911

DESIGNATION	TYPE	H	B	F	L	CATALOG #
HEL2525M22	EL22	25	25	25	150	TH200018
HEL3232M22	EL22	32	32	32	170	TH200021
HER2525M22	ER22	25	25	25	150	TH200017
HER3232M22	ER22	32	32	32	170	TH200020

* Accessories on request

INSERT SCREW TH290022
SHIM SCREW TH290023
KEY M2000603

INTERNAL RIGHT HANDED TOOL HOLDERS

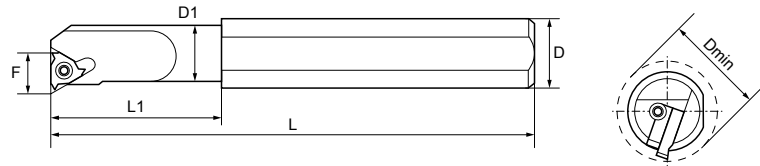

DESIGNATION	TYPE	D	D1	D min	L	L1	F	CATALOG #
HIR0010H11	IR11	10	10	12.5	100	-	7.3	TH200010
HIR0010K11	IR11	16	10	12.5	125	25	7.3	TH200013

* Accessories on request

INSERT SCREW M2001549
KEY M2000601

DESIGNATION	TYPE	D	D1	D min	L	L1	F	CATALOG #
HIR0013M16	IR16	16	13	16.5	150	32	10.4	TH200016
HIR0016P16	IR16	20	16	19.5	170	40	11.6	TH200019
HIR0020P16	IR16	20	20	23.5	170	-	13.6	TH200022
HIR0025R16	IR16	25	25	28.5	200	-	16.3	TH200025

* Accessories on request

INSERT SCREW TH290008
SHIM SCREW TH290021
KEY M2002911

MILLING



FACE MILLING	109
SHOULDER MILLING	127
HIGH FEED MILLING	145
COPY MILLING	155
SLOT MILLING	167

MAGIA MILLING GRADES

High performance grades for top level machining

CHOOSE THE RIGHT PREMIUM MILLING GRADE

LT 3000 - RECOMMENDED FOR GENERAL USE

- Progressive and predictable wear. The silver top layer of our MULTI-MAT™ LT 3000 shows higher contrast on worn edges making it easy to identify which edges have been used and the level of wear development.
- More flexibility and extended application range. With a more tolerant coating, LT 3000 permits added flexibility and a wider application range as it can be applied at higher and lower cutting speeds than LT 30.

LT 3130 - RECOMMENDED FOR STEELS & STAINLESS STEELS

- MAGIA PRO LT 3130 has been specifically designed for remarkable performance in steels and stainless steels
- Low friction coefficient reduces heat generation and provides excellent thermal stability for milling at high speeds
- Higher hardness delivers substantial improvement in tool life and exceptional wear resistance leading to fewer production stops



MILLING GRADES - LT 30, LT 3000, LT 3130

INSERT DESIGNATION (BASED ON ISO NORMS)



1. Insert Shape

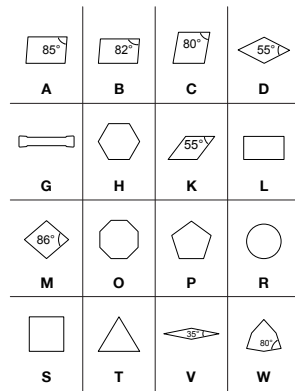

2. Clearance Angle

Letter Symbol	α
A	3°
B	5°
C	7°
D	15°
E	20°
F	25°
G	30°
N	0°
P	11°
O	Special

3. Tolerance Class

Symbol	D	M	S
A	± 0.025	± 0.005	± 0.025
C	± 0.025	± 0.013	± 0.025
E	± 0.025	± 0.025	± 0.025
F	± 0.013	± 0.005	± 0.025
G	± 0.025	± 0.025	± 0.130
H	± 0.013	± 0.013	± 0.025
J*	$\pm 0.05-0.15$	± 0.005	± 0.025
K*	$\pm 0.05-0.15$	± 0.013	± 0.025
L*	$\pm 0.05-0.15$	± 0.025	± 0.025
M*	$\pm 0.05-0.15$	$\pm 0.08-0.20$	± 0.130
N*	$\pm 0.05-0.15$	$\pm 0.08-0.20$	± 0.025
U*	$\pm 0.08-0.25$	$\pm 0.13-0.38$	± 0.130

* Depending on the insert size.

4. Fixing and Chipbreaker Types

Type	Symbol	Type	Symbol
A		N	
B		P	
F		R	
G		T	
H		W	
M		X	Special Design

5. Cutting Edge Length

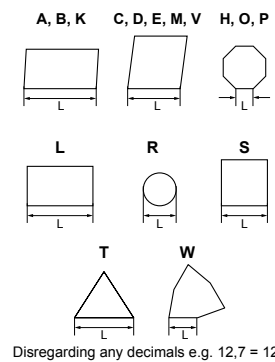

Disregarding any decimals e.g. 12,7 = 12

6. Insert Thickness

Symbol	mm
01	= 1.59
T1	= 1.98
02	= 2.38
03	= 3.18
T3	= 3.97
04	= 4.76
05	= 5.56
06	= 6.35
07	= 7.94
09	= 9.52

7. Insert Corner Radius

1 st letter (Milling)	2 nd letter (Milling)
A = 45°	A = 3°
D = 60°	B = 5°
E = 75°	C = 7°
F = 85°	D = 15°
P = 90°	E = 20°
Z = other	F = 25°
	G = 30°
	N = 0°
	P = 11°
	Z = other

8. Edge Preparation

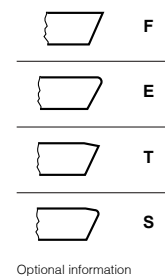

Optional information

9. Cutting Direction

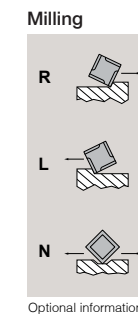

Optional information

10. Internal Designation

e.g. Application (Milling)
 - 45 = 45° Approach Angle
 - 90 = 90° Approach Angle
 - HF = High Feed

Optional information

LAMINA TECHNOLOGIES CUTTER DESIGNATION

LT 741 C - W - D016 / 2

1	2	3	4	5	6
1. Standard	2. Lamina Cutter Family Number	3. Coupling	4. Internal Coolant	5. Diameter	6. # of Teeth
LT - Metric RILT - Imperial		C - Cylindrical CL - Cylindrical Long W - Weldon WL - Weldon Long M - Shell Mill S - Screw Coupling FW - Long Edge	D - No Internal Coolant W - Internal Coolant	D016 = 16 mm D1000 = 1"	2 = 2 teeth

LAMINA MILLING CUTTER LINES

CUTTER LINE	FITS INSERT
LT 060	RD.. 0602 M0
LT 070	RD.. 0702 M0
LT 080	RD.. 0803 M0
LT 100	RD.. 10T3 M0
LT 101	RX.. 10T3 M0
LT 120	RD.. 1204 M0
LT 121	RX.. 1204 M0
LT 160	RD.. 1604 M0
LT 400	SPMT 060304 TN SPMT 09T308 FN/TN SPMT 120408 TN
LT 600	SEKT 1204 AFTN
LT 610	SEKT 12T3 AGSN
LT 645	HNKX 0604-45
LT 731	APKT 160408 PDTR

CUTTER LINE	FITS INSERT
LT 737	APKT 1705 PETR
LT 741	APKT 100308 PDTR
LT 745	APKT 100332/40 PDTR
LT 752	APKT 060204 PDTR
LT 770	LDMT 1504 PDSR
LT 790	ADKT 1505 PDTR
LT 800	OFMT 05T305 TN
LT 902	SDKX 0904-HF
LT 903	SDKX 1205-HF
LT 910	XPKT 0602-HF XPKW 0602-HF
LT 946	SNKX 1205-45
LT 947	SNKX 1607-45
LT 987	ONKX 0806-45

LTEXT C - W - M10

1	2	3	4	5
LT - Metric RILT - Imperial	Screw-on Coupling Extension	C - Cylindric W - Weldon S - Screw Coupling	D - No Internal Coolant W - Internal Coolant	Coupling Dimension
6	7	8	9	10
Shank Diameter	Neck Diameter	Total Length	Neck Length	ST - Steel CC - Cemented Carbide

D19(19) L150(30) - ST

RECOMMENDED SCREW COUPLING TIGHTENING TORQUES

CONNECTING THREAD SIZE	TIGHTENING TORQUE	MOUNTING KEY SIZE (MM)
M6	10 NM	9
M8	25 NM	11
M10	40 NM	15
M12	60 NM	19
M16	80 NM	26

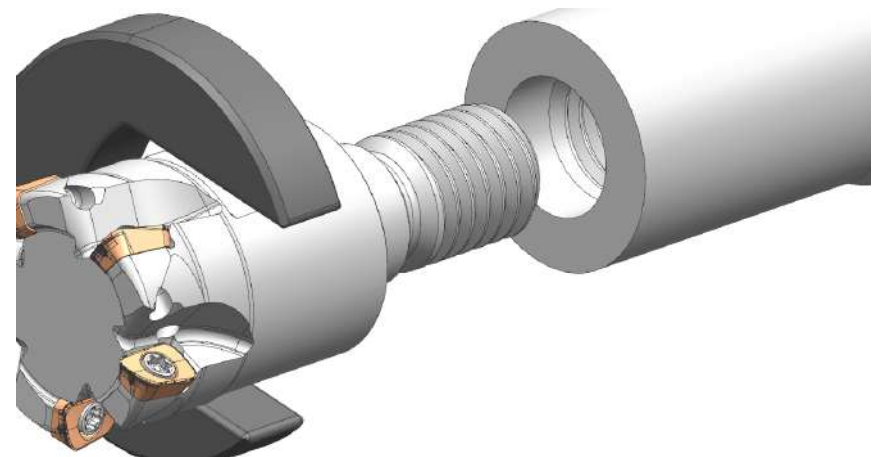

MILLING

EXTENSIONS FOR SCREW COUPLING

CATALOG	LAMINA DESIGNATION	D	D1	L	L1	M	TYPE	MATERIAL
M2004932	LT EXT C-W-M08-D15(14) L150(30)-ST	15	14	150	30	M08	A	STEEL
M2004933	LT EXT C-W-M08-D16(14) L100(30)-ST*	16	14	100	30	M08	A	STEEL
M2004934	LT EXT C-W-M08-D16(14) L150(30)-ST	16	14	150	30	M08	A	STEEL
M2004935	LT EXT C-W-M10-D19(19) L150(30)-ST	19	18.7	150	30	M10	A	STEEL
M2004936	LT EXT C-W-M10-D20(19) L100(30)-ST*	20	18.7	100	30	M10	A	STEEL
M2004937	LT EXT C-W-M10-D20(19) L150(40)-ST	20	18.7	150	40	M10	A	STEEL
M2004938	LT EXT C-W-M12-D24(22) L150(40)-ST	24	22	150	40	M12	A	STEEL
M2004939	LT EXT C-W-M12-D25(22) L150(40)-ST*	25	22	150	40	M12	A	STEEL
M2004940	LT EXT C-W-M12-D25(22) L200(40)-ST	25	22	200	40	M12	A	STEEL
M2004941	LT EXT C-W-M12-D25(22) L250(40)-ST	25	22	250	40	M12	A	STEEL
M2004942	LT EXT C-W-M16-D32(30) L170(40)-ST	32	30	170	40	M16	A	STEEL
M2004943	LT EXT C-W-M16-D32(30) L220(40)-ST	32	30	220	40	M16	A	STEEL
M2004944	LT EXT C-W-M16-D32(30) L300(40)-ST	32	30	300	40	M16	A	STEEL
M2004949	LT EXT C-W-M06-D12(12) L100(24)-CC*	12	11.8	100	24	M06	A	CARBIDE**
M2004957	LT EXT C-W-M06-D12(12) L200(00)-CC*	12	12	200	00	M06	B	CARBIDE**
M2004968	LT EXT C-W-M06-D16(12) L150(70)-CC*	16	11.8	150	70	M06	A	CARBIDE**
M2004951	LT EXT C-W-M08-D16(15) L150(30)-CC*	16	15	150	30	M08	A	CARBIDE**
M2004952	LT EXT C-W-M08-D16(15) L200(40)-CC*	16	15	200	40	M08	A	CARBIDE**
M2004958	LT EXT C-W-M08-D16(16) L250(00)-CC*	16	16	250	00	M08	B	CARBIDE**
M2004945	LT EXT C-W-M08-D20(16) L200(90)-CC*	20	16	200	90	M08	A	CARBIDE**
M2004950	LT EXT C-W-M10-D20(19) L150(40)-CC*	20	19	150	40	M10	A	CARBIDE**
M2004953	LT EXT C-W-M10-D20(19) L150(40)-CC*	20	19	150	40	M10	A	CARBIDE**
M2004954	LT EXT C-W-M10-D20(19) L200(40)-CC*	20	19	200	40	M10	A	CARBIDE**
M2004959	LT EXT C-W-M10-D20(20) L250(00)-CC*	20	20	250	00	M10	B	CARBIDE**
M2004960	LT EXT C-W-M10-D20(20) L300(00)-CC*	20	20	300	00	M10	B	CARBIDE**
M2004946	LT EXT C-W-M10-D25(20) L200(90)-CC*	25	20	200	90	M10	A	CARBIDE**
M2004955	LT EXT C-W-M12-D25(24) L150(48)-CC*	25	24	150	48	M12	A	CARBIDE**
M2004956	LT EXT C-W-M12-D25(24) L200(48)-CC*	25	24	200	48	M12	A	CARBIDE**
M2004947	LT EXT C-W-M12-D32(25) L200(90)-CC*	32	25	200	90	M12	A	CARBIDE**

* On request.

**CC = Cemented Carbide shanks decrease vibration risks

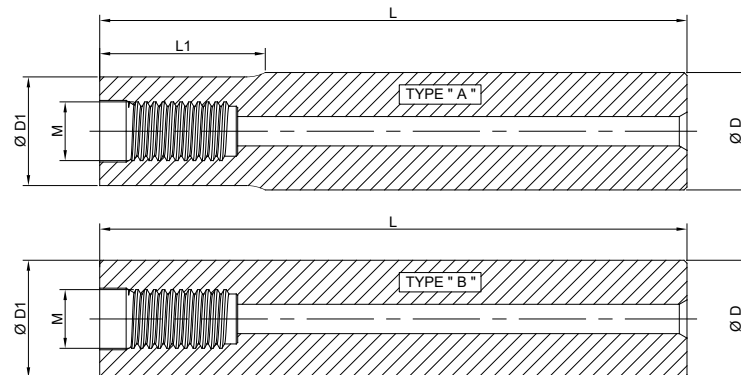

FACE MILLING

FACE MILLING



FACE MILLING

FEATURED GEOMETRIES

SNKX

- Square positive insert with 8 cutting edges
- Full MULTI-MAT™ flexibility in a thick and strong insert
- Positive edges provide soft and stable cut

ONKX

- Double-sided octagonal milling insert for face milling
- Economical solution with 16 cutting edges!
- Roughing and Semi-Finishing
- Mostly recommended for use on steel and cast Iron - up to 4.5mm d.o.c.

HNKX

- Double-sided hexagonal insert with 12 cutting edges
- MAGIA LT 3000 and MAGIA PRO LT 3130 for steels and stainless steels
- Positive edges provide soft and stable cut

SEKT



MAGIA PRO

DESIGNATION	GRADE	RADIUS (mm)	CUTTING EDGES	CUTTER LINE	MATERIAL RECOMMENDATION	CUTTING DATA	CATALOG #
SEKT 1204 AFTN	LT 3130	-	4	LT 600		p. 322	M0004486
SEKT 12T3 AGSN	LT 3130	-	4	LT 610		p. 322	M0004487

MAGIA

DESIGNATION	GRADE	RADIUS (mm)	CUTTING EDGES	CUTTER LINE	MATERIAL RECOMMENDATION	CUTTING DATA	CATALOG #
SEKT 1204 AFTN	LT 3000	-	4	LT 600		p. 296	M0002230
SEKT 12T3 AGSN	LT 3000	-	4	LT 610		p. 296	M0002231

ALPHA

DESIGNATION	GRADE	RADIUS (mm)	CUTTING EDGES	CUTTER LINE	MATERIAL RECOMMENDATION	CUTTING DATA	CATALOG #
SEKT 1204 AFTN	LT 30	-	4	LT 600		p. 296	M0000045
SEKT 12T3 AGSN	LT 30	-	4	LT 610		p. 296	M0000455

CUTTERS SEKT

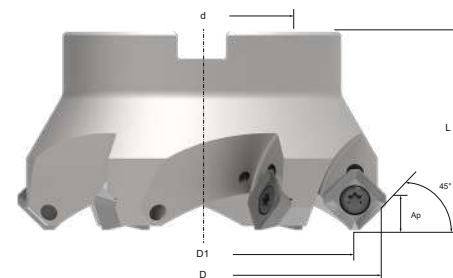

SHELL MILL - SEKT 1204

DESIGNATION	D	D1	d	L	Ap	Z	α	CATALOG #
LT 600 M-W-D040/3	53	40	16	40	6	3	10	M2000546
LT 600 M-W-D050/4	63	50	22	48	6	4	8	M2000547
LT 600 M-W-D063/5	76	63	22	48	6	5	6	M2000548
LT 600 M-W-D080/6	93	80	27	50	6	6	4.5	M2000549
LT 600 M-W-D100/6	113	100	32	50	6	6	3.5	M2000550

SCREW M2000599
KEY M2000603

SHELL MILL - SEKT 12T3

DESIGNATION	D	D1	d	L	Ap	Z	α	CATALOG #
LT 610 M-W-D040/3	53	40	16	40	6	3	10	M2001431
LT 610 M-W-D050/4	63	50	22	48	6	4	8	M2001382
LT 610 M-W-D063/5	76	63	22	48	6	5	6	M2001383
LT 610 M-W-D080/6	93	80	27	50	6	6	4.5	M2001384
LT 610 M-W-D100/6	113	100	32	50	6	6	3.5	M2001432

SCREW M2001418
KEY M2000602

MATERIAL GROUP

- STEEL
- STAINLESS STEEL
- CAST IRON
- HIGH TEMP ALLOYS
- HARDENED MATERIAL
- ALU(>8%Si)

COOLANT



p. 357

ORDERING EXAMPLE

QUANTITY 10 PIECES
DESIGNATION + GRADE APKT 060204 PDTR LT 3000
CATALOG NUMBER M0004026

TECHNICAL SECTION



p. 366 - 376

SNKX



MAGIA PRO

DESIGNATION	GRADE	RADIUS (mm)	CUTTING EDGES	CUTTER LINE	MATERIAL RECOMMENDATION	CUTTING DATA	CATALOG #
SNKX 1205-45	LT 3130	-	8	LT 946		p. 323	M0004490
SNKX 1607-45	LT 3130	-	8	LT 947		p. 323	M0004491

MAGIA

DESIGNATION	GRADE	RADIUS (mm)	CUTTING EDGES	CUTTER LINE	MATERIAL RECOMMENDATION	CUTTING DATA	CATALOG #
SNKX 1205-45	LT 3000	-	8	LT 946		p. 297	M0003415
SNKX 1607-45	LT 3000	-	8	LT 947		p. 298	M0002237

ALPHA

DESIGNATION	GRADE	RADIUS (mm)	CUTTING EDGES	CUTTER LINE	MATERIAL RECOMMENDATION	CUTTING DATA	CATALOG #
SNKX 1205-45	LT 30	-	8	LT 946		p. 297	M0003221
SNKX 1607-45	LT 30	-	8	LT 947		p. 298	M0002205

CUTTERS SNKX - 45

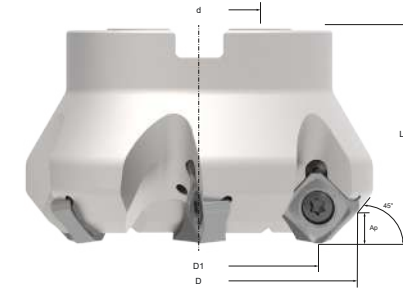

SHELL MILL - SNKX 1205-45

DESIGNATION	D	D1	d	L	Ap	Z	CATALOG #
LT 946 M-W-D050/4	64	50	22	48	6	4	M2003223
LT 946 M-W-D063/6	77	63	22	48	6	6	M2003224
LT 946 M-W-D080/7	94	80	27	50	6	7	M2003225
LT 946 M-W-D100/8	114	100	32	50	6	8	M2003226
LT 946 M-W-D125/10	139	125	40	63	6	10	M2003227
LT 946 M-D-D160/12*	174	160	40	63	6	12	M2003228

*On Request

SCREW KEY M2003295
M2003296

SHELL MILL - SNKX 1607-45

DESIGNATION	D	D1	d	L	Ap	Z	CATALOG #
LT 947 M-W-D050/4	69	50	22	50	7	4	M2002200
LT 947 M-W-D063/5	82	63	22	50	7	5	M2002201
LT 947 M-W-D080/6	99	80	27	50	7	6	M2002202
LT 947 M-W-D100/7	119	100	32	63	7	7	M2002203
LT 947 M-W-D125/8	144	125	40	63	7	8	M2002204
LT 947 M-D-D160/10	179	160	40	63	7	10	M2003670
LT 947 M-D-D200/12*	219	200	60	63	7	12	M2003671
LT 947 M-D-D250/14*	269	250	60	63	7	14	M2003672

*On Request

SCREW KEY M2002733
M2000603

MATERIAL GROUP

- STEEL
- STAINLESS STEEL
- CAST IRON
- HIGH TEMP ALLOYS
- HARDENED MATERIAL
- ALU(>8%Si)

COOLANT



p. 357

ORDERING EXAMPLE

QUANTITY 10 PIECES
DESIGNATION + GRADE APKT 060204 PDTR LT 3000
CATALOG NUMBER M0004026

TECHNICAL SECTION



p. 366 - 376

H N K X



MAGIA PRO

DESIGNATION	GRADE	RADIUS (mm)	CUTTING EDGES	CUTTER LINE	MATERIAL RECOMMENDATION	CUTTING DATA	CATALOG #
HNKX 0604-45	LT 3130	-	12	LT 645		p. 314	M0004473

MAGIA

DESIGNATION	GRADE	RADIUS (mm)	CUTTING EDGES	CUTTER LINE	MATERIAL RECOMMENDATION	CUTTING DATA	CATALOG #
HNKX 0604-45	LT 3000	-	12	LT 645		p. 276	M0004364

CUTTERS HNKX

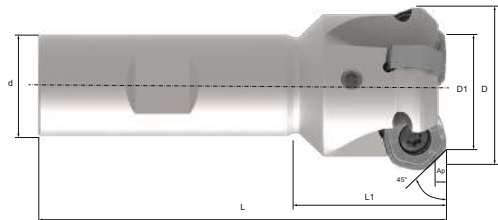

END MILL - HNKX 0604-45

DESIGNATION	D	D1	d	L	L1	Ap	Z	CATALOG #
LT 645 W-W-D025/3	34	25	20	32	82	3.2	3	M2001440
LT 645 W-W-D032/4	41	32	25	40	97	3.2	4	M2001441
LT 645 W-W-D040/5	49	40	32	40	115	3.2	5	M2001442

SCREW KEY
M2000597
M2000602

CUTTERS HNKX - 45

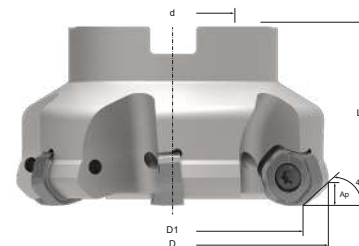

SHELL MILL - HNKX 0604-45

DESIGNATION	D	D1	d	L1	Ap	Z	CATALOG #
LT 645 M-W-D050/5	59	50	22	40	3.2	5	M2001435
LT 645 M-W-D063/6	72	63	22	40	3.2	6	M2001436
LT 645 M-W-D080/8	89	80	27	50	3.2	8	M2001437
LT 645 M-W-D100/9	109	100	32	50	3.2	9	M2001438
LT 645 M-W-D125/12	134	125	40	63	3.2	12	M2001439

SCREW KEY
M2000597
M2000602

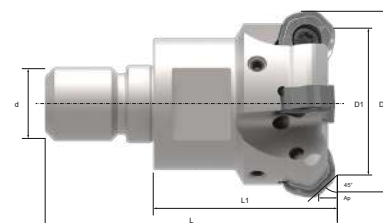

SCREW COUPLING - HNKX 0604-45

DESIGNATION	D	D1	d	L	Ap	Z	CATALOG #
LT 645 S-W-D025/3	34	25	M16	32	3.2	3	M2001443
LT 645 S-W-D032/4	41	32	M16	40	3.2	4	M2001444
LT 645 S-W-D040/5	49	40	M16	40	3.2	5	M2001445

SCREW KEY
M2000597
M2000602

MATERIAL GROUP

- STEEL
- STAINLESS STEEL
- CAST IRON
- HIGH TEMP ALLOYS
- HARDENED MATERIAL
- ALU(>8%SI)

COOLANT



p. 357

ORDERING EXAMPLE

QUANTITY 10 PIECES
DESIGNATION + GRADE APKT 060204 PDTR LT 3000
CATALOG NUMBER M0004026

TECHNICAL SECTION



p. 366 - 376

ONKX



CUTTERS ONKX

MAGIA PRO

DESIGNATION	GRADE	RADIUS (mm)	CUTTING EDGES	CUTTER LINE	MATERIAL RECOMMENDATION	CUTTING DATA	CATALOG #
ONKX 0806-45	LT 3130	0.8	16	LT 987		p. 315	M0004475

MAGIA

DESIGNATION	GRADE	RADIUS (mm)	CUTTING EDGES	CUTTER LINE	MATERIAL RECOMMENDATION	CUTTING DATA	CATALOG #
ONKX 0806-45	LT 3000	0.8	16	LT 987		p. 282	M0002211

ALPHA

DESIGNATION	GRADE	RADIUS (mm)	CUTTING EDGES	CUTTER LINE	MATERIAL RECOMMENDATION	CUTTING DATA	CATALOG #
ONKX 0806-45	LT 30	0.8	16	LT 987		p. 282	M0003673

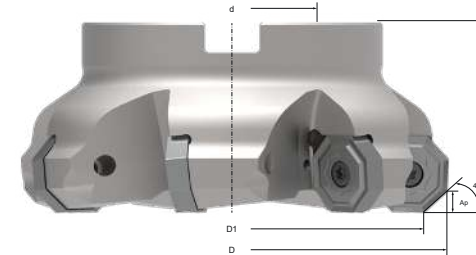

SHELL MILL - ONKX 0806

DESIGNATION	D	D1	d	L	Ap	Z	CATALOG #
LT 987 M-W-D063/5	75.7	63	22	50	5	5	M2003631
LT 987 M-W-D080/6	92.7	80	27	50	5	6	M2003632
LT 987 M-W-D100/7	112.7	100	32	50	5	7	M2003633
LT 987 M-W-D125/8	137.7	125	40	63	5	8	M2003634
LT 987 M-D-D160/10 ¹	172.7	160	40	63	5	10	M2003635
LT 987 M-D-D200/12 ¹	212.7	200	60	63	5	12	M2003636
LT 987 M-D-D250/14 ¹	262.7	250	60	63	5	14	M2003637

¹On Request

SCREW M2000599
KEY M2000603

¹ Accessories for coolant available

CUTTER	ACCESSORY
M2003635	M2004024
M2003636	M2001847
M2003637	M2001847

MATERIAL GROUP

- STEEL
- STAINLESS STEEL
- CAST IRON
- HIGH TEMP ALLOYS
- HARDENED MATERIAL
- ALU(>8%SI)

COOLANT



p. 357

ORDERING EXAMPLE

QUANTITY 10 PIECES
DESIGNATION + GRADE APKT 060204 PDTR LT 3000
CATALOG NUMBER M0004026

TECHNICAL SECTION



p. 366 - 376

OFMT



MAGIA

DESIGNATION	GRADE	RADIUS (mm)	CUTTING EDGES	CUTTER LINE	MATERIAL RECOMMENDATION	CUTTING DATA	CATALOG #
OFMT 050405 TR	LT 3000	0.8	8	-		p. 278	M0002220
OFMT 05T305 TN	LT 3000	0.8	8	LT 800		p. 278	M0002221
OFMT 070405 TN	LT 3000	0.5	8	-		p. 281	M0002222

ALPHA

DESIGNATION	GRADE	RADIUS (mm)	CUTTING EDGES	CUTTER LINE	MATERIAL RECOMMENDATION	CUTTING DATA	CATALOG #
OFMT 050405 TR	LT 30	0.8	8	-		p. 278	M0000034
OFMT 05T305 TN	LT 30	0.8	8	LT 800		p. 278	M0000591
OFMT 070405 TN	LT 30	0.5	8	-		p. 281	M0000592

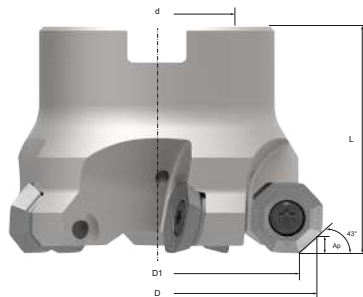

SHELL MILL - OFMT 05T305 TN

DESIGNATION	D	D1	d	L	Ap	Z	CATALOG #
LT 800 M-W-D040/3	47	40	16	40	3	3	M2000502
LT 800 M-W-D050/4	57	50	22	40	3	4	M2000503
LT 800 M-W-D063/5	70	63	22	40	3	5	M2000504
LT 800 M-W-D080/6	87	80	27	50	3	6	M2000505
LT 800 M-W-D100/7	107	100	32	50	3	7	M2000506
LT 800 M-W-D125/8	132	125	40	63	3	8	M2000507

SCREW M2000597
KEY M2000602

MATERIAL GROUP

- STEEL
- STAINLESS STEEL
- CAST IRON
- HIGH TEMP ALLOYS
- HARDENED MATERIAL
- ALU(>8%Si)

COOLANT



p. 357

ORDERING EXAMPLE

QUANTITY 10 PIECES
DESIGNATION + GRADE APKT 060204 PDTR LT 3000
CATALOG NUMBER M0004026

TECHNICAL SECTION



p. 366 - 376

ODMT



MAGIA

DESIGNATION	GRADE	RADIUS (mm)	CUTTING EDGES	CUTTER LINE	MATERIAL RECOMMENDATION	CUTTING DATA	CATALOG #
ODMT 0504 ZZTR	LT 3000	0.80	8	-		p. 278	M0003399
ODMT 060508 TN	LT 3000	0.80	8	-		p. 279	M0002219

ALPHA

DESIGNATION	GRADE	RADIUS (mm)	CUTTING EDGES	CUTTER LINE	MATERIAL RECOMMENDATION	CUTTING DATA	CATALOG #
ODMT 0504 ZZTR	LT 30	0.80	8	-		p. 278	M0000664
ODMT 060508 TN	LT 30	0.80	8	-		p. 279	M0001104

ODMW



MAGIA

DESIGNATION	GRADE	RADIUS (mm)	CUTTING EDGES	CUTTER LINE	MATERIAL RECOMMENDATION	CUTTING DATA	CATALOG #
ODMW 060508 TN	LT 3000	0.80	8	-		p. 280	M0003400

ALPHA

DESIGNATION	GRADE	RADIUS (mm)	CUTTING EDGES	CUTTER LINE	MATERIAL RECOMMENDATION	CUTTING DATA	CATALOG #
ODMW 060508 TN	LT 30	0.80	8	-		p. 280	M0000451

MATERIAL GROUP

- STEEL
- STAINLESS STEEL
- CAST IRON
- HIGH TEMP ALLOYS
- HARDENED MATERIAL
- ALU(>8%Si)

COOLANT



p. 357

ORDERING EXAMPLE

QUANTITY 10 PIECES
DESIGNATION + GRADE APKT 060204 PDTR LT 3000
CATALOG NUMBER M0004026

TECHNICAL SECTION



p. 366 - 376

O F E R



MAGIA

DESIGNATION	GRADE	RADIUS (mm)	CUTTING EDGES	CUTTER LINE	MATERIAL RECOMMENDATION	CUTTING DATA	CATALOG #
OFER 070405 TN	LT 3000	0.80	8	-		p. 281	M0003401

ALPHA

DESIGNATION	GRADE	RADIUS (mm)	CUTTING EDGES	CUTTER LINE	MATERIAL RECOMMENDATION	CUTTING DATA	CATALOG #
OFER 070405 TN	LT 30	0.80	8	-		p. 281	M0000033

S E K N



MAGIA

DESIGNATION	GRADE	RADIUS (mm)	CUTTING EDGES	CUTTER LINE	MATERIAL RECOMMENDATION	CUTTING DATA	CATALOG #
SEKN 1203 AFTN	LT 3000	-	4	-		p. 294	M0004031
SEKN 1204 AFTN	LT 3000	-	4	-		p. 294	M0004032
SEKN 1504 AFTN	LT 3000	-	4	-		p. 295	M0004033

ALPHA

DESIGNATION	GRADE	RADIUS (mm)	CUTTING EDGES	CUTTER LINE	MATERIAL RECOMMENDATION	CUTTING DATA	CATALOG #
SEKN 1203 AFTN	LT 30	-	4	-		p. 294	M0000041
SEKN 1204 AFTN	LT 30	-	4	-		p. 294	M0000042
SEKN 1504 AFTN	LT 30	-	4	-		p. 295	M0000045

S E K R



MAGIA

DESIGNATION	GRADE	RADIUS (mm)	CUTTING EDGES	CUTTER LINE	MATERIAL RECOMMENDATION	CUTTING DATA	CATALOG #
SEKR 1203 AFTN	LT 3000	-	4	-		p. 294	M0004034
SEKR 1204 AFTN	LT 3000	-	4	-		p. 294	M0004035

ALPHA

DESIGNATION	GRADE	RADIUS (mm)	CUTTING EDGES	CUTTER LINE	MATERIAL RECOMMENDATION	CUTTING DATA	CATALOG #
SEKR 1203 AFTN	LT 30	-	4	-		p. 294	M0000043
SEKR 1204 AFTN	LT 30	-	4	-		p. 294	M0000044

S D K T



MAGIA

DESIGNATION	GRADE	RADIUS (mm)	CUTTING EDGES	CUTTER LINE	MATERIAL RECOMMENDATION	CUTTING DATA	CATALOG #
SDKT 1204 AETN	LT 3000	-	4	-		p. 290	M0003411

ALPHA

DESIGNATION	GRADE	RADIUS (mm)	CUTTING EDGES	CUTTER LINE	MATERIAL RECOMMENDATION	CUTTING DATA	CATALOG #
SDKT 1204 AETN	LT 30	-	4	-		p. 290	M0000171

MATERIAL GROUP

- STEEL
- STAINLESS STEEL
- CAST IRON
- HIGH TEMP ALLOYS
- HARDENED MATERIAL
- ALU(>8%Si)

COOLANT



p. 357

ORDERING EXAMPLE

QUANTITY 10 PIECES
 DESIGNATION + GRADE APKT 060204 PDTR LT 3000
 CATALOG NUMBER M0004026

TECHNICAL SECTION



p. 366 - 376

MATERIAL GROUP

- STEEL
- STAINLESS STEEL
- CAST IRON
- HIGH TEMP ALLOYS
- HARDENED MATERIAL
- ALU(>8%Si)

COOLANT



p. 357

ORDERING EXAMPLE

QUANTITY 10 PIECES
 DESIGNATION + GRADE APKT 060204 PDTR LT 3000
 CATALOG NUMBER M0004026

TECHNICAL SECTION



p. 366 - 376

SPUN



MAGIA

DESIGNATION	GRADE	RADIUS (mm)	CUTTING EDGES	CUTTER LINE	MATERIAL RECOMMENDATION	CUTTING DATA	CATALOG #
SPUN 120308	LT 3000	0.80	4	-		p. 306	M0004039

ALPHA

DESIGNATION	GRADE	RADIUS (mm)	CUTTING EDGES	CUTTER LINE	MATERIAL RECOMMENDATION	CUTTING DATA	CATALOG #
SPUN 120308	LT 30	0.80	4	-		p. 306	M0000050

SPKN



MAGIA

DESIGNATION	GRADE	RADIUS (mm)	CUTTING EDGES	CUTTER LINE	MATERIAL RECOMMENDATION	CUTTING DATA	CATALOG #
SPKN 1203 EDTR	LT 3000	-	4	-		p. 299	M0004036
SPKN 1204 EDTR	LT 3000	-	4	-		p. 299	M0004181
SPKN 1504 EDTR	LT 3000	-	4	-		p. 299	M0004037

ALPHA

DESIGNATION	GRADE	RADIUS (mm)	CUTTING EDGES	CUTTER LINE	MATERIAL RECOMMENDATION	CUTTING DATA	CATALOG #
SPKN 1203 EDTR	LT 30	-	4	-		p. 299	M0000046
SPKN 1204 EDTR	LT 30	-	4	-		p. 299	M0000047
SPKN 1504 EDTR	LT 30	-	4	-		p. 299	M0001673

SPKR



MAGIA

DESIGNATION	GRADE	RADIUS (mm)	CUTTING EDGES	CUTTER LINE	MATERIAL RECOMMENDATION	CUTTING DATA	CATALOG #
SPKR 1203 EDTR	LT 3000	-	4	-		p. 300	M0004038
SPKR 1204 EDTR	LT 3000	-	4	-		p. 300	M0004182

ALPHA

DESIGNATION	GRADE	RADIUS (mm)	CUTTING EDGES	CUTTER LINE	MATERIAL RECOMMENDATION	CUTTING DATA	CATALOG #
SPKR 1203 EDTR	LT 30	-	4	-		p. 300	M0000048
SPKR 1204 EDTR	LT 30	-	4	-		p. 300	M0000049

MATERIAL GROUP

- STEEL
- STAINLESS STEEL
- CAST IRON
- HIGH TEMP ALLOYS
- HARDENED MATERIAL
- ALU(>8%Si)

COOLANT



p. 357

ORDERING EXAMPLE

QUANTITY 10 PIECES
 DESIGNATION + GRADE APKT 060204 PDTR LT 3000
 CATALOG NUMBER M0004026

TECHNICAL SECTION



p. 366 - 376

MATERIAL GROUP

- STEEL
- STAINLESS STEEL
- CAST IRON
- HIGH TEMP ALLOYS
- HARDENED MATERIAL
- ALU(>8%Si)

COOLANT



p. 357

ORDERING EXAMPLE

QUANTITY 10 PIECES
 DESIGNATION + GRADE APKT 060204 PDTR LT 3000
 CATALOG NUMBER M0004026

TECHNICAL SECTION



p. 366 - 376

SHOULDER MILLING

**Decrease your
tooling costs**



90° SHOULDER MILLING

MAXIMUM VERSATILITY

90° inserts can be used in a wide ranges of applications including

- Shoulder milling
- Plunging
- Pocket milling
- Surfacing
- Ramping down
- Helical interpolation
- Slotting milling

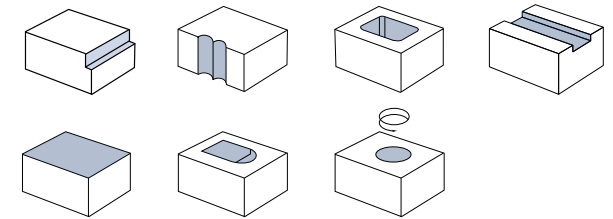

FEATURED GEOMETRY

APKT

- MULTI-MAT™ geometry for maximum versatility
- Accurate 90° wall finishing
- Excellent ramping down ability



ANKX



CUTTERS ANKX

MAGIA PRO

DESIGNATION	GRADE	RADIUS (mm)	CUTTING EDGES	CUTTER LINE	MATERIAL RECOMMENDATION	CUTTING DATA	CATALOG #
ANKX 170608 PNTR	LT 3130	0.8	4	LT 787		P. 312	M0004025

MAGIA

DESIGNATION	GRADE	RADIUS (mm)	CUTTING EDGES	CUTTER LINE	MATERIAL RECOMMENDATION	CUTTING DATA	CATALOG #
ANKX 170608 PNTR	LT 3000	0.8	4	LT 787		p. 268	M0004467

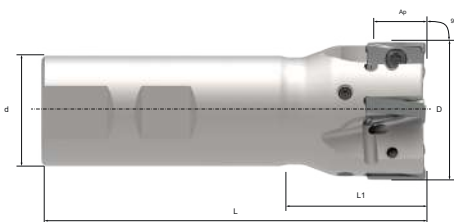
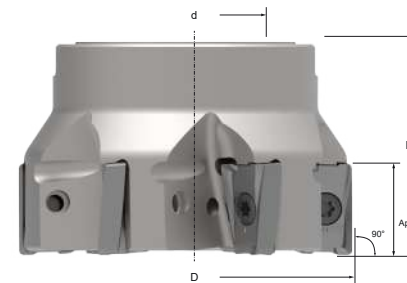

SHELL MILL - ANKX 170608 PNTR

DESIGNATION	D	d	L	Ap	Z	CATALOG #
LT 787 M-W-D040/4	40	16	40	12	4	M2001790
LT 787 M-W-D050/5	50	22	40	12	5	M2001793
LT 787 M-W-D063/6	63	22	40	12	6	M2001794
LT 787 M-W-D080/7	80	27	50	12	7	M2001795
LT 787 M-W-D100/8	100	32	50	12	8	M2003825
LT 787 M-W-D125/9	125	40	63	12	9	M2003826
LT 787 M-D-D160/10*	160	40	63	12	10	M2003827

SCREW M2000597
KEY M2000602

END MILL - ANKX 170608 PNTR

DESIGNATION	D	d	L	L1	Ap	Z	CATALOG #
LT 787 W-D-D025/2	25	25	44	100	12	2	M2001787
LT 787 W-W-D032/3	32	32	50	110	12	3	M2001789
LT 787 W-W-D040/4	40	32	50	115	12	4	M2001792

SCREW M2000597
KEY M2000602

ANKX and cutter family LT 787 Available Q4 2019

ANKX and cutter family LT 787 Available Q4 2019

MATERIAL GROUP

- STEEL
- STAINLESS STEEL
- CAST IRON
- HIGH TEMP ALLOYS
- HARDENED MATERIAL
- ALU(>8%SI)

COOLANT



p. 357

ORDERING EXAMPLE

QUANTITY 10 PIECES
DESIGNATION + GRADE APKT 060204 PDTR LT 3000
CATALOG NUMBER M0004026

TECHNICAL SECTION



p. 366 - 376

* On Request.

APKT



MAGIA PRO

DESIGNATION	GRADE	RADIUS (mm)	CUTTING EDGES	CUTTER LINE	MATERIAL RECOMMENDATION	CUTTING DATA	CATALOG #
APKT 060204 PDTR	LT 3130	0.40	2	LT 752		p. 310	M0004468
APKT 100308 PDTR [†]	LT 3130	0.80	2	LT 741		p. 312	M0004470
APKT 160408 PDTR [†]	LT 3130	0.80	2	LT 731		p. 312	M0004471

MAGIA

DESIGNATION	GRADE	RADIUS (mm)	CUTTING EDGES	CUTTER LINE	MATERIAL RECOMMENDATION	CUTTING DATA	CATALOG #
APKT 060204 PDTR	LT 3000	0.40	2	LT 752		p. 260	M0004026
APKT 100304 PDTR	LT 3000	0.40	2	LT 741		p. 262	M0003389
APKT 100308 PDTR [†]	LT 3000	0.80	2	LT 741		p. 263	M0003388
APKT 100312 PDTR	LT 3000	1.20	2	LT 741		p. 264	M0003391
APKT 100316 PDTR	LT 3000	1.60	2	LT 741		p. 265	M0003392
APKT 100332 PDTR	LT 3000	3.20	2	LT 745		p. 266	M0003394
APKT 100340 PDTR	LT 3000	4.00	2	LT 745		p. 267	M0003395
APKT 160408 PDTR [†]	LT 3000	0.80	2	LT 731		p. 268	M0002182
APKT 160416 PDTR	LT 3000	1.60	2	LT 731		p. 269	M0004027
APKT 160424 PDTR [†]	LT 3000	2.40	2	LT 731		p. 270	M0004029
APKT 160432 PDTR	LT 3000	3.20	2	LT 731		p. 271	M0004030
APKT 1705 PETR	LT 3000	0.80	2	LT 737		p. 272	M0002212

ALPHA

DESIGNATION	GRADE	RADIUS (mm)	CUTTING EDGES	CUTTER LINE	MATERIAL RECOMMENDATION	CUTTING DATA	CATALOG #
APKT 100304 PDTR	LT 30	0.40	2	LT 741		p. 262	M0002920
APKT 100308 PDTR [†]	LT 30	0.80	2	LT 741		p. 263	M0002918
APKT 100312 PDTR	LT 30	1.20	2	LT 741		p. 264	M0002921
APKT 100316 PDTR	LT 30	1.60	2	LT 741		p. 265	M0003094
APKT 100332 PDTR	LT 30	3.20	2	LT 745		p. 266	M0002922
APKT 100340 PDTR	LT 30	4.00	2	LT 745		p. 267	M0002923
APKT 1604 PDTR	LT 30	0.95	2	-		p. 268	M0000021
APKT 160408 PDTR [†]	LT 30	0.80	2	LT 731		p. 268	M0000022
APKT 160416 PDTR	LT 30	1.60	2	LT 731		p. 269	M0000172
APKT 160424 PDTR [†]	LT 30	2.40	2	LT 731		p. 270	M0003833
APKT 160432 PDTR	LT 30	3.20	2	LT 731		p. 271	M0001569
APKT 1705 PETR	LT 30	0.80	2	LT 737		p. 272	M0001810

MATERIAL GROUP

- STEEL
- STAINLESS STEEL
- CAST IRON
- HIGH TEMP ALLOYS
- HARDENED MATERIAL
- ALU(>8%Si)

COOLANT



p. 357

ORDERING EXAMPLE

QUANTITY 10 PIECES
 DESIGNATION + GRADE APKT 060204 PDTR LT 3000
 CATALOG NUMBER M0004026

TECHNICAL SECTION



p. 366 - 376

MATERIAL GROUP

- STEEL
- STAINLESS STEEL
- CAST IRON
- HIGH TEMP ALLOYS
- HARDENED MATERIAL
- ALU(>8%Si)

COOLANT



p. 357

ORDERING EXAMPLE

QUANTITY 10 PIECES
 DESIGNATION + GRADE APKT 060204 PDTR LT 3000
 CATALOG NUMBER M0004026

TECHNICAL SECTION



p. 366 - 376

CUTTERS APKT

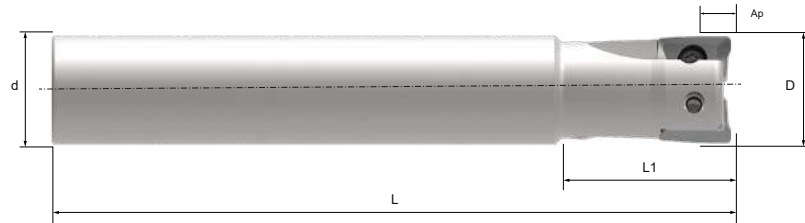

END MILL - APKT 060204 PDTR**

DESIGNATION	D	d	L	L1	Ap	Z	α°	CATALOG #
LT 752 C-W-D010/2	10	10	72	16	5.2	2	3.00	M2003098
LT 752 C-W-D012/3	12	12	80	26	5.2	3	2.20	M2003099
LT 752 CL-W-D012/3*	12	10	120	13.5	5.2	3	2.20	M2003078
LT 752 C-W-D016/4	16	16	90	32	5.2	4	1.50	M2003100
LT 752 CL-W-D016/3*	16	14	160	13.5	5.2	3	1.50	M2003105
LT 752 C-W-D020/5	20	20	100	40	5.2	5	1.15	M2003101
LT 752 CL-W-D020/4*	20	18	200	13.5	5.2	4	1.15	M2003080
LT 752 C-W-D025/7	25	20	120	40	5.2	4	0.90	M2003102
LT 752 CL-W-D025/6*	25	20	220	15	5.2	4	0.90	M2003081

*Available Q3 2017

SCREW M2001640
 SCREW DRIVER HANDLE M2002922
 PRESET ADAPTER 0.4NM M2002923
 TORX PLUS BIT M2003064

END MILL - APKT 100308 PDTR / APKT 100304 PDTR / APKT 100312 PDTR / APKT 100316 PDTR

DESIGNATION	D	d	L	L1	Ap	Z	α	CATALOG #
LT 741 C-W-D016/2	16	16	100	25	9	2	7.50	M2002806
LT 741 CL-W-D016/2	16	16	150	35	9	2	7.50	M2002817
LT 741 C-W-D018/2	18	20	100	30	9	2	6.00	M2002807
LT 741 C-W-D020/3	20	20	100	30	9	3	5.00	M2002808
LT 741 CL-W-D020/3	20	20	150	35	9	3	5.00	M2002818
LT 741 C-W-D022/3	22	20	100	30	9	3	4.00	M2002809
LT 741 C-W-D025/3	25	25	120	30	9	3	3.30	M2002810
LT 741 C-W-D025/4	25	25	120	30	9	4	3.30	M2002811
LT 741 CL-W-D025/4	25	25	200	40	9	4	3.30	M2002819
LT 741 C-W-D028/4	28	25	120	30	9	4	2.70	M2002812
LT 741 C-W-D030/4	30	25	120	30	9	4	2.30	M2002813
LT 741 W-W-D032/5	32	32	120	30	9	5	2.00	M2002814
LT 741 WL-W-D032/4	32	32	200	40	9	4	2.00	M2002820

SCREW M2002181
 KEY M2000601

** Due to the small size of these inserts, using a pre-set torque screw driver (0.4Nm) at all times is recommended. It is also recommended that during mounting, the insert should be held in place with a finger.

CUTTERS APKT

END MILL - APKT 100332/40

DESIGNATION	D	d	L	L1	Ap	Z	α	CATALOG #
LT 745 W-W-D016/2*	16	16	100	25	9	2	10	M2001587
LT 745 WL-W-D016/2*	16	16	150	35	9	2	10	M2001849
LT 745 W-W-D020/3*	20	20	100	30	9	3	7	M2001589
LT 745 WL-W-D020/3*	20	20	150	35	9	3	7	M2001850
LT 745 W-W-D025/3*	25	25	120	30	9	3	5	M2001591
LT 745 WL-W-D025/4*	25	25	200	40	9	4	5	M2001851
LT 745 WL-W-D032/4*	32	32	200	40	9	4	3	M2001852
LT 745 W-W-D032/5*	32	32	120	30	9	5	3	M2001848

*On Request

SCREW M2002181
 KEY M2000601

END MILL - APKT 160408 PDTR

DESIGNATION	D	d	L	L1	Ap	Z	α	CATALOG #
LT 731 W-W-D025/2	25	25	100	44	15	2	5	M2002966
LT 731 WL-W-D025/2	25	25	220	90	15	2	5	M2002965
LT 731 W-W-D032/3	32	32	110	50	15	3	3	M2002968
LT 731 WL-W-D032/3	32	32	220	90	15	3	3	M2002967
LT 731 W-W-D040/4	40	32	115	50	15	4	2.5	M2002970
LT 731 WL-W-D040/4	40	32	220	90	15	4	2.5	M2002969

SCREW M2000597
 KEY M2000602

END MILL - APKT 1705

DESIGNATION	D	d	L	L1	Ap	Z	α	CATALOG #
LT 737 W-W-D025/2	25	20	100	32	16	2	5	M2001833
LT 737 WL-W-D025/2	25	25	210	40	16	2	5	M2001836
LT 737 W-W-D032/3	32	32	110	40	16	3	3	M2001834
LT 737 WL-W-D032/3	32	32	200	65	16	3	3	M2001837
LT 737 W-W-D040/4	40	32	115	45	16	4	2.5	M2001835
LT 737 WL-W-D040/4	40	32	200	45	16	4	2.5	M2001982

SCREW M2000597
 KEY M2000602

CUTTERS APKT

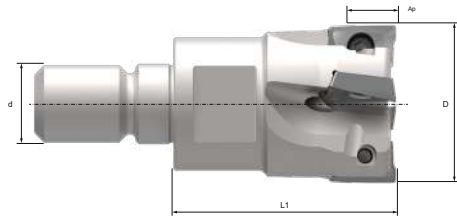

SCREW COUPLING - APKT 060204 PDTR**

DESIGNATION	D	d	L1	Ap	Z	α°	CATALOG #
LT 752 S-W-D010/2*	10	M6	19	0.5	2	3.00	M2003087
LT 752 S-W-D012/3*	12	M6	19	0.5	3	2.20	M2003088
LT 752 S-W-D016/4*	16	M8	22	0.5	4	1.50	M2003089
LT 752 S-W-D020/5*	20	M10	25	0.5	5	1.15	M2003090
LT 752 S-W-D025/7*	25	M12	25	0.5	7	0.90	M2003091
LT 752 S-W-D032/8*	32	M16	30	0.5	8	0.70	M2003094

*Available Q3 2017

- SCREW M2001640
- SCREW DRIVER HANDLE M2002922
- PRESET ADAPTER 0.4NM M2002923
- TORX PLUS BIT M2003064

SCREW COUPLING - APKT 100308 PDTR / 100304 PDTR / 100312 PDTR / 100316 PDTR

DESIGNATION	D	d	L1	Ap	Z	α	CATALOG #
LT 741 S-W-D016/2	16	M8	25	9	2	7.50	M2002962
LT 741 S-W-D020/3	20	M10	30	9	3	5.00	M2002963
LT 741 S-W-D025/4	25	M12	35	9	4	3.30	M2002964

- SCREW M2002181
- KEY M2000601

** Due to the small size of these inserts, using a pre-set torque screw driver (0.4Nm) at all times is recommended. It is also recommended that during mounting, the insert should be held in place with a finger.

CUTTERS APKT

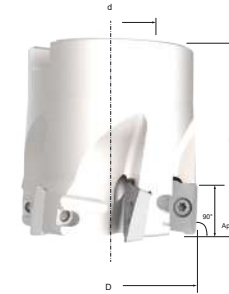

SHELL MILL - APKT 100308 PDTR / 100304 PDTR / 100312 PDTR / 100316 PDTR

DESIGNATION	D	d	L	Ap	Z	α	CATALOG #
LT 741 M-W-D040/6	40	16	40	9	6	1.5	M2002798
LT 741 M-W-D050/7	50	22	40	9	7	1.1	M2002799
LT 741 M-W-D063/8	63	22	40	9	8	0.9	M2002800
LT 741 M-W-D080/11*	80	27	50	9	11	0.7	M2002801

*On Request

- SCREW M2002181
- KEY M2000601

SHELL MILL - APKT 100332/40

DESIGNATION	D	d	L	Ap	Z	α	CATALOG #
LT 745 M-W-D040/6*	40	16	40	9	6	2.0	M2001580
LT 745 M-W-D050/7*	50	22	40	9	7	1.8	M2001581

*On Request

- SCREW M2002181
- KEY M2000601

SHELL MILL - APKT 160408 PDTR

DESIGNATION	D	d	L	Ap	Z	α	CATALOG #
LT 731 M-W-D040/4	40	16	40	15	4	2.5	M2002971
LT 731 M-W-D050/5	50	22	40	15	5	2.2	M2002972
LT 731 M-W-D063/6	63	22	40	15	6	1.8	M2002973
LT 731 M-W-D080/7	80	27	50	15	7	1.4	M2002974
LT 731 M-W-D100/8	100	32	50	15	8	1.1	M2002975
LT 731 M-W-D125/9	125	40	63	15	9	0.8	M2002976
LT 731 M-D-D160/10*	160	40	63	15	10	N/A	M2002977

*On Request

- SCREW M2000597
- KEY M2000602

SHELL MILL - APKT 1705

DESIGNATION	D	d	L	Ap	Z	α	CATALOG #
LT 737 M-W-D040/4	40	16	40	16	4	2.5	M2001838
LT 737 M-W-D050/5	50	22	40	16	5	2.2	M2001839
LT 737 M-W-D063/6	63	22	40	16	6	1.8	M2001841
LT 737 M-W-D080/7	80	27	50	16	7	1.4	M2001842
LT 737 M-W-D100/7	100	32	50	16	7	1.1	M2001843
LT 737 M-W-D125/9	125	40	63	16	9	0.8	M2001844

- SCREW M2000597
- KEY M2000602

ADKT



CUTTERS ADKT

MAGIA

DESIGNATION	GRADE	RADIUS (mm)	CUTTING EDGES	CUTTER LINE	MATERIAL RECOMMENDATION	CUTTING DATA	CATALOG #
ADKT 1505 PDTR	LT 3000	0.96	2	LT 790		p. 258	M0002209

ALPHA

DESIGNATION	GRADE	RADIUS (mm)	CUTTING EDGES	CUTTER LINE	MATERIAL RECOMMENDATION	CUTTING DATA	CATALOG #
ADKT 1505 PDTR	LT 30	0.96	2	LT 790		p. 258	M0001573

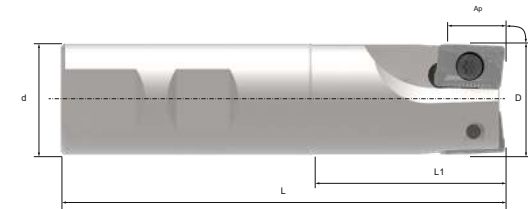

END MILL - ADKT 1505

DESIGNATION	D	d	L	L1	Ap	Z	α	CATALOG #
LT 790 W-W-D025/2*	25	25	100	44	15	2	5.0	M2001613
LT 790 W-W-D032/3*	32	32	110	50	15	3	3.0	M2001503

*On Request

SCREW M2000597
KEY M2000602

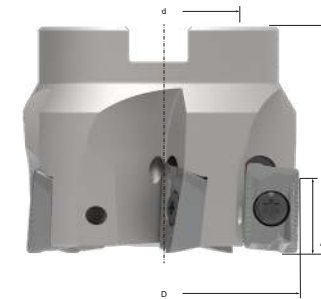

SHELL MILL - ADKT 1505

DESIGNATION	D	d	L	Ap	Z	α	CATALOG #
LT 790 M-W-D040/4*	40	16	40	15	4	2.5	M2001615
LT 790 M-W-D050/5*	50	22	40	15	5	2.2	M2001504
LT 790 M-W-D063/6*	63	22	40	15	6	1.8	M2001616
LT 790 M-W-D080/7*	80	27	50	15	7	1.4	M2001617

*On Request

SCREW M2000597
KEY M2000602

MATERIAL GROUP

- STEEL
- STAINLESS STEEL
- CAST IRON
- HIGH TEMP ALLOYS
- HARDENED MATERIAL
- ALU(>8%SI)

COOLANT



p. 357

ORDERING EXAMPLE

QUANTITY 10 PIECES
DESIGNATION + GRADE APKT 060204 PDTR LT 3000
CATALOG NUMBER M0004026

TECHNICAL SECTION



p. 366 - 376

LDMT



ALPHA

DESIGNATION	GRADE	RADIUS (mm)	CUTTING EDGES	CUTTER LINE	MATERIAL RECOMMENDATION	CUTTING DATA	CATALOG #
LDMT 1504 PDSR	LT 30	0.74	2	LT 770		p. 277	M0001772

SPMT



MAGIA

DESIGNATION	GRADE	RADIUS (mm)	CUTTING EDGES	CUTTER LINE	MATERIAL RECOMMENDATION	CUTTING DATA	CATALOG #
SPMT 12T308	LT 3000	0.80	4	LT 710		p. 304	M0003420

ALPHA

DESIGNATION	GRADE	RADIUS (mm)	CUTTING EDGES	CUTTER LINE	MATERIAL RECOMMENDATION	CUTTING DATA	CATALOG #
SPMT 12T308	LT 30	0.80	4	LT 710		p. 304	M0001226

CUTTERS LDMT

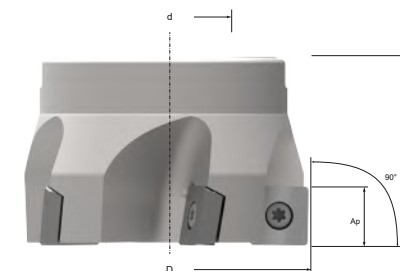
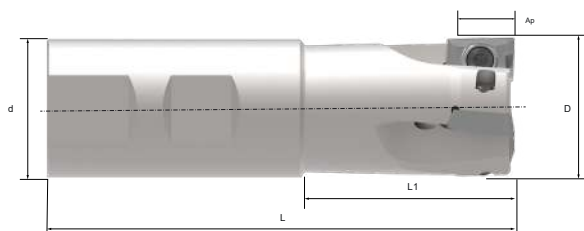

END MILL - LDMT 1504

DESIGNATION	D	d	L	L1	Ap	Z	α	CATALOG #
LT 770 W-W-D025/2*	25	25	100	44	15	2	5	M2001822
LT 770 W-W-D032/3*	32	35	110	50	15	3	3	M2001823
LT 770 W-W-D040/4*	40	32	115	45	15	4	2.5	M2001824

*On Request

SCREW M2001418
KEY M2000602

SHELL MILL - SPMT 12T308

DESIGNATION	D	d	L	Ap	Z	CATALOG #
LT 710 M-W-D050/4	50	22	40	10.7	4	M2004927
LT 710 M-W-D063/5	63	22	40	10.7	5	M2004928
LT 710 M-W-D080/7	80	27	50	10.7	7	M2004929
LT 710 M-W-D100/9	100	32	50	10.7	9	M2004930
LT 710 M-W-D125/11	125	40	63	10.7	11	M2004931

SCREW M2001418
KEY M2000602

MATERIAL GROUP

- STEEL
- STAINLESS STEEL
- CAST IRON
- HIGH TEMP ALLOYS
- HARDENED MATERIAL
- ALU(>8%Si)

COOLANT



p. 357

ORDERING EXAMPLE

QUANTITY 10 PIECES
DESIGNATION + GRADE APKT 060204 PDTR LT 3000
CATALOG NUMBER M0004026

TECHNICAL SECTION



p. 366 - 376

MATERIAL GROUP

- STEEL
- STAINLESS STEEL
- CAST IRON
- HIGH TEMP ALLOYS
- HARDENED MATERIAL
- ALU(>8%Si)

COOLANT



p. 357

ORDERING EXAMPLE

QUANTITY 10 PIECES
DESIGNATION + GRADE APKT 060204 PDTR LT 3000
CATALOG NUMBER M0004026

TECHNICAL SECTION



p. 366 - 376

TPKN



MAGIA

DESIGNATION	GRADE	RADIUS (mm)	CUTTING EDGES	CUTTER LINE	MATERIAL RECOMMENDATION	CUTTING DATA	CATALOG #
TPKN 1603 PDTR	LT 3000	1.2	3	-		p. 306	M0004040
TPKN 2204 PDTR	LT 3000	1.2	3	-		p. 306	M0004041

ALPHA

DESIGNATION	GRADE	RADIUS (mm)	CUTTING EDGES	CUTTER LINE	MATERIAL RECOMMENDATION	CUTTING DATA	CATALOG #
TPKN 1603 PDTR	LT 30	1.2	3	-		p. 306	M0000051
TPKN 2204 PDTR	LT 30	1.2	3	-		p. 306	M0000052

TPKR



MAGIA

DESIGNATION	GRADE	RADIUS (mm)	CUTTING EDGES	CUTTER LINE	MATERIAL RECOMMENDATION	CUTTING DATA	CATALOG #
TPKR 1603 PDTR	LT 3000	1.20	3	-		p. 307	M0004042
TPKR 2204 PDTR	LT 3000	1.20	3	-		p. 308	M0004043

ALPHA

DESIGNATION	GRADE	RADIUS (mm)	CUTTING EDGES	CUTTER LINE	MATERIAL RECOMMENDATION	CUTTING DATA	CATALOG #
TPKR 1603 PDTR	LT 30	1.20	3	-		p. 307	M0000053
TPKR 2204 PDTR	LT 30	1.20	3	-		p. 308	M0000983

TPUN



MAGIA

DESIGNATION	GRADE	RADIUS (mm)	CUTTING EDGES	CUTTER LINE	MATERIAL RECOMMENDATION	CUTTING DATA	CATALOG #
TPUN 160308	LT 3000	0.80	3	-		p. 309	M0004044

ALPHA

DESIGNATION	GRADE	RADIUS (mm)	CUTTING EDGES	CUTTER LINE	MATERIAL RECOMMENDATION	CUTTING DATA	CATALOG #
TPUN 160308	LT 30	0.80	3	-		p. 309	M0000054

MATERIAL GROUP

- STEEL
- STAINLESS STEEL
- CAST IRON
- HIGH TEMP ALLOYS
- HARDENED MATERIAL
- ALU(>8%Si)

COOLANT



p. 357

ORDERING EXAMPLE

QUANTITY 10 PIECES
 DESIGNATION + GRADE APKT 060204 PDTR LT 3000
 CATALOG NUMBER M0004026

TECHNICAL SECTION



p. 366 - 376

MATERIAL GROUP

- STEEL
- STAINLESS STEEL
- CAST IRON
- HIGH TEMP ALLOYS
- HARDENED MATERIAL
- ALU(>8%Si)

COOLANT



p. 357

ORDERING EXAMPLE

QUANTITY 10 PIECES
 DESIGNATION + GRADE APKT 060204 PDTR LT 3000
 CATALOG NUMBER M0004026

TECHNICAL SECTION



p. 366 - 376

A O M T

HIGH FEED
MILLING

MAGIA

DESIGNATION	GRADE	RADIUS (mm)	CUTTING EDGES	CUTTER LINE	MATERIAL RECOMMENDATION	CUTTING DATA	CATALOG #
AOMT 123608 PETR	LT 3000	0.70	2	-		p. 259	M0002210

ALPHA

DESIGNATION	GRADE	RADIUS (mm)	CUTTING EDGES	CUTTER LINE	MATERIAL RECOMMENDATION	CUTTING DATA	CATALOG #
AOMT 123608 PETR	LT 30	0.70	2	-		p. 259	M0001640

A P M T



MAGIA

DESIGNATION	GRADE	RADIUS (mm)	CUTTING EDGES	CUTTER LINE	MATERIAL RECOMMENDATION	CUTTING DATA	CATALOG #
APMT 0903 PDTR	LT 3000	0.40	2	-		p. 263	M0004161
APMT 1135 PDTR	LT 3000	0.70	2	-		p. 274	M0002216
APMT 1604 PDTR	LT 3000	0.66	2	-		p. 275	M0002183
APMT 160408 PDTR	LT 3000	0.70	2	-		p. 275	M0002218

ALPHA

DESIGNATION	GRADE	RADIUS (mm)	CUTTING EDGES	CUTTER LINE	MATERIAL RECOMMENDATION	CUTTING DATA	CATALOG #
APMT 0903 PDTR	LT 30	0.40	2	-		p. 263	M0000663
APMT 1135 PDTR	LT 30	0.70	2	-		p. 274	M0001133
APMT 1604 PDTR	LT 30	0.66	2	-		p. 275	M0001134
APMT 160408 PDTR	LT 30	0.70	2	-		p. 275	M0001733

MATERIAL GROUP

STEEL	HIGH TEMP ALLOYS
STAINLESS STEEL	HARDENED MATERIAL
CAST IRON	ALU(>8%SI)

COOLANT



p. 357

ORDERING EXAMPLE

QUANTITY	10 PIECES
DESIGNATION + GRADE	APKT 060204 PDTR LT 3000
CATALOG NUMBER	M0004026

TECHNICAL SECTION



p. 366 - 376

SOLUTIONS FOR RAPID MATERIAL REMOVAL

BOOST PRODUCTIVITY, CUT COSTS

Using a shallow depth of cut with a small approach angle ensures the cutting forces are directed towards the machine spindle in the axial direction, which results in greater tool stability.

- More stable cut (less vibrations)
- Excellent metal removal rate
- Potential increase in feed rates up to 10 times the normal rates

As a leading company in milling operations, Lamina is continually expanding its High Feed line. From diameter 3mm to 80mm, we offer the solution to increase productivity in a wide variety of milling applications and workpiece materials.



SDKW



MAGIA PRO

DESIGNATION	GRADE	RADIUS (mm)	CUTTING EDGES	CUTTER LINE	MATERIAL RECOMMENDATION	CUTTING DATA	CATALOG #
SDKW 0904-HF	LT 3130	2.0	4	LT 902		p. 321	M0004482
SDKW 1205-HF	LT 3130	2.5	4	LT 903		p. 321	M0004483

MAGIA

DESIGNATION	GRADE	RADIUS (mm)	CUTTING EDGES	CUTTER LINE	MATERIAL RECOMMENDATION	CUTTING DATA	CATALOG #
SDKW 0904-HF	LT 3000	2.0	4	LT 902		p. 291	M0004263
SDKW 1205-HF	LT 3000	2.5	4	LT 903		p. 291	M0004224

SDKX



MAGIA PRO

DESIGNATION	GRADE	RADIUS (mm)	CUTTING EDGES	CUTTER LINE	MATERIAL RECOMMENDATION	CUTTING DATA	CATALOG #
SDKX 0904-HF	LT 3130	2.0	4	LT 902		p. 320	M0004484
SDKX 1205-HF	LT 3130	2.5	4	LT 903		p. 320	M0004485

MAGIA

DESIGNATION	GRADE	RADIUS (mm)	CUTTING EDGES	CUTTER LINE	MATERIAL RECOMMENDATION	CUTTING DATA	CATALOG #
SDKX 0904-HF	LT 3000	2.0	4	LT 902		p. 292	M0003412
SDKX 1205-HF	LT 3000	2.5	4	LT 903		p. 293	M0003413

CUTTERS SDKX / SDKW

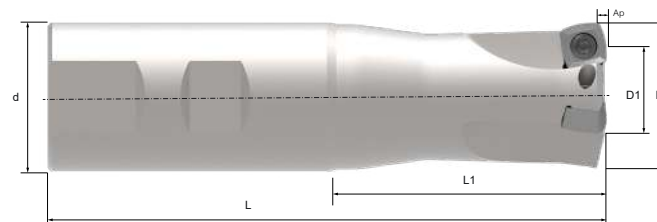

END MILL - SDKW 0904-HF / SDKX 0904-HF

DESIGNATION	D	D1	d	L	L1	Ap	Z	α	CATALOG #
LT 902 W-W-D025/2	25	9.6	25	120	60	1.5	2	2	M2003351
LT 902 WL-W-D025/2	25	9.6	25	200	60	1.5	2	2	M2003350
LT 902 W-W-D032/3	32	16.6	32	120	60	1.5	3	2	M2003353
LT 902 WL-W-D032/3	32	16.6	32	200	60	1.5	3	2	M2003352

SCREW KEY M2001420
M2000602

END MILL - SDKW 1205-HF / SDKX 1205 HF

DESIGNATION	D	D1	d	L	L1	Ap	Z	α	CATALOG #
LT 903 W-W-D032/2	32	11.0	32	120	60	2	2	2	M2003366
LT 903 WL-W-D032/2	32	11.0	32	200	60	2	2	2	M2003365

SCREW KEY M2000597
M2000602

MATERIAL GROUP

- STEEL
- STAINLESS STEEL
- CAST IRON
- HIGH TEMP ALLOYS
- HARDENED MATERIAL
- ALU(>8%SI)

COOLANT



p. 357

ORDERING EXAMPLE

QUANTITY 10 PIECES
DESIGNATION + GRADE APKT 060204 PDTR LT 3000
CATALOG NUMBER M0004026

TECHNICAL SECTION



p. 366 - 376

X P K T



MAGIA PRO

DESIGNATION	GRADE	RADIUS (mm)	CUTTING EDGES	CUTTER LINE	MATERIAL RECOMMENDATION	CUTTING DATA	CATALOG #
XPKT 0602-HF	LT 3130	1.20	2	LT 910		p. 310	M0005548

MAGIA

DESIGNATION	GRADE	RADIUS (mm)	CUTTING EDGES	CUTTER LINE	MATERIAL RECOMMENDATION	CUTTING DATA	CATALOG #
XPKT 0602-HF	LT 3000	1.20	2	LT 910		p. 261	M0005549

X P K W



MAGIA PRO

DESIGNATION	GRADE	RADIUS (mm)	CUTTING EDGES	CUTTER LINE	MATERIAL RECOMMENDATION	CUTTING DATA	CATALOG #
XPKW 0602-HF	LT 3130	1.20*	2	LT 910		p. 311	M0005544

MAGIA

DESIGNATION	GRADE	RADIUS (mm)	CUTTING EDGES	CUTTER LINE	MATERIAL RECOMMENDATION	CUTTING DATA	CATALOG #
XPKW 0602-HF	LT 3000	1.20	2	LT 910		p. 273	M0005545

CUTTERS XPKT / XPKW

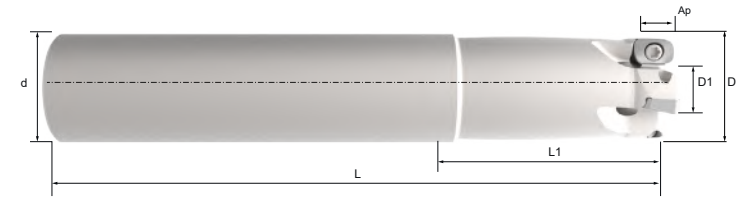

END MILL - XPKT 0602-HF** / XPKW 0602-HF**

DESIGNATION	D	D1	d	L	L1	Ap	Z	α°	CATALOG #
LT 910 C-W-D010/2	10	4.7	10	72	16	0.5	2	3.25	M2005574
LT 910 C-W-D012/3	12	6.7	12	80	26	0.5	3	2.50	M2005573
LT 910 CL-W-D012/3	12	6.7	10	120	13.5	0.5	3	2.50	M2005568
LT 910 C-W-D016/4	16	10.7	16	90	32	0.5	4	2.00	M2005572
LT 910 CL-W-D016/3	16	10.7	14	160	13.5	0.5	3	2.00	M2005583
LT 910 C-W-D020/5	20	14.7	20	100	40	0.5	5	1.25	M2005571
LT 910 CL-W-D020/4	20	14.7	18	200	13.5	0.5	4	1.25	M2005581
LT 910 C-W-D025/7	25	19.7	20	120	40	0.5	4	0.90	M2005570
LT 910 CL-W-D025/6	25	19.7	20	220	15	0.5	4	0.90	M2005580

- SCREW M2001640
- SCREW DRIVER HANDLE M2002922
- PRESET ADAPTER 0.4NM M2002923
- TORX PLUS BIT M2003064

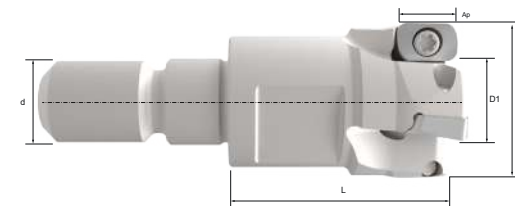

SCREW COUPLING - XPKT 0602-HF** / XPKW 0602-HF**

DESIGNATION	D	D1	d	L1	Ap	Z	α_{HF}	CATALOG #
LT 910 S-W-D010/2	10	4.7	M6	19	0.5	2	3.250	M2005578
LT 910 S-W-D012/3	12	6.7	M6	19	0.5	3	2.50	M2003088
LT 910 S-W-D016/4	16	10.7	M8	22	0.5	4	2.00	M2005577
LT 910 S-W-D020/5	20	14.7	M10	25	0.5	5	1.25	M2005576
LT 910 S-W-D025/7	25	19.7	M12	25	0.5	7	0.90	M2005559
LT 910 S-W-D032/8	32	26.7	M16	30	0.5	8	0.70	M2005558

- SCREW M2001640
- SCREW DRIVER HANDLE M2002922
- PRESET ADAPTER 0.4NM M2002923
- TORX PLUS BIT M2003064

* XPKT, XPKW and cutter family LT 910 Available Q4 2019

* XPKT, XPKW and cutter family LT 910 Available Q4 2019

** Due to the small size of these inserts, using a pre-set torque screw driver (0.4Nm) at all times is recommended. It is also recommended that during mounting, the insert should be held in place with a finger.

MATERIAL GROUP

- STEEL
- STAINLESS STEEL
- CAST IRON
- HIGH TEMP ALLOYS
- HARDENED MATERIAL
- ALU(>8%SI)

COOLANT



p. 357

ORDERING EXAMPLE

QUANTITY 10 PIECES
 DESIGNATION + GRADE APKT 060204 PDTR LT 3000
 CATALOG NUMBER M0004026

TECHNICAL SECTION



p. 366 - 376

CUTTERS SDKX / SDKW

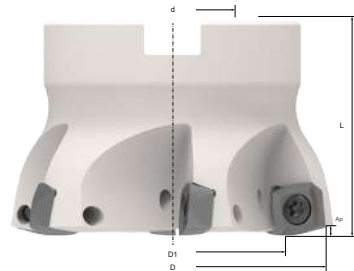

SHELL MILL - SDKX 0904-HF / SDKW 0904-HF

DESIGNATION	D	D1	d	L	Ap	Z	α	CATALOG #
LT 902 M-W-D040/5	40	24.6	16	40	1.5	5	0.8	M2003341
LT 902 M-W-D042/5	42	26.6	16	40	1.5	5	0.8	M2003342
LT 902 M-W-D050/6	50	34.6	22	40	1.5	6	0.7	M2003343
LT 902 M-W-D052/6	52	36.6	22	40	1.5	6	0.7	M2003344
LT 902 M-W-D063/6	63	47.6	22	40	1.5	6	0.6	M2003345
LT 902 M-W-D066/6	66	50.6	22	40	1.5	6	0.6	M2003346

SCREW KEY M2001420
M2000602

SHELL MILL - SDKX 1205-HF / SDKW 1205-HF

DESIGNATION	D	D1	d	L	Ap	Z	α	CATALOG #
LT 903 M-W-D050/4	50	29.0	22	40	2	4	0.8	M2003661
LT 903 M-W-D050/5	50	29.0	22	40	2	5	0.8	M2003357
LT 903 M-W-D052/5	52	31.0	22	40	2	5	0.8	M2003358
LT 903 M-W-D063/5	63	42.0	22	40	2	5	0.6	M2003662
LT 903 M-W-D063/6	63	42.0	22	40	2	6	0.6	M2003360
LT 903 M-W-D066/6	66	45.0	22	40	2	6	0.6	M2003361
LT 903 M-W-D066/6-D27	66	45.0	27	40	2	6	0.6	M2004168
LT 903 M-W-D080/6	80	59.0	27	50	2	6	0.4	M2003663
LT 903 M-W-D080/8	80	59.0	27	50	2	8	0.4	M2003452

SCREW KEY M2000597
M2000602

CUTTERS SDKX / SDKW

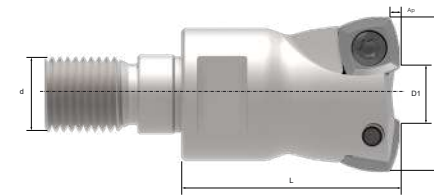

SCREW COUPLING - SDKX 0904-HF / SDKW 0904-HF

DESIGNATION	D	D1	d	L1	Ap	Z	α	CATALOG #
LT 902 S-W-D025/2	25	9.6	M12	35	1.5	2	2.0	M2003347
LT 902 S-W-D032/3	32	16.6	M16	35	1.5	3	1.5	M2003348
LT 902 S-W-D035/4	35	19.6	M16	35	1.5	4	0.8	M2003349

SCREW KEY M2001420
M2000602

SCREW COUPLING - SDKX 1205-HF / SDKW 1205-HF

DESIGNATION	D	D1	d	L1	Ap	Z	α	CATALOG #
LT 903 S-W-D032/2	32	11.0	M16	35	2	2	2.0	M2003362
LT 903 S-W-D035/2	35	14.0	M16	35	2	2	1.5	M2003364
LT 903 S-W-D040/4	40	19	M16	40	2	4	0.8	M2003354
LT 903 S-W-D042/4*	42	21	M16	35	2	4	0.8	M2003356

*On Request

SCREW KEY M2000597
M2000602

COPY
MILLING

**With Lamina you have
the right tool, at the right
time, all the time**



COPY MILLING SOLUTIONS

ADVANTAGES OF ROUND INSERTS

Versatile, used for copying, face milling, ramping, plunging, pocket milling and helical interpolation

STRONGEST INSERT SHAPE

- Reliable even in difficult operations
- Strongest insert shape, no corners to break

ECONOMICAL SOLUTION

- Multiple edges per insert
- 4-8 effective indexes depending on depth of cut

SMOOTH AND STABLE CUT

- Even with long overhangs
- Good distribution of cutting forces

NEW PRODUCTS - RX.. INSERTS WITH LOCATION FLATS

Lamina Technologies introduces three new round insert geometries with indexing flats: RXMT, RXMW and RXMX

- Indexing flats provide for
 - Stable insert mounting
 - Reliable machining of difficult materials in challenging conditions
 - Higher feeds and depths of cut
 - Anti-rotation insert

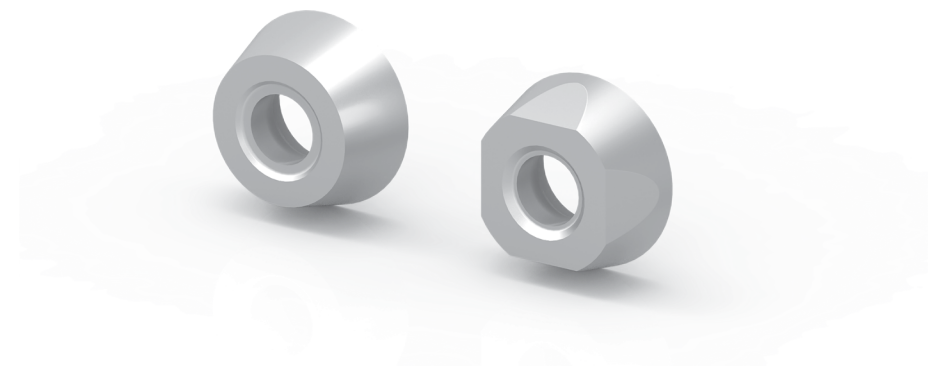

R D M T



MAGIA

DESIGNATION	GRADE	RADIUS (mm)	CUTTING EDGES	CUTTER LINE	MATERIAL RECOMMENDATION	CUTTING DATA	CATALOG #
RDMT 0602 M0	LT 3000	3	-	LT 060		p. 283	M0003403
RDMT 0702 M0	LT 3000	3.5	-	LT 070		p. 284	M0003404
RDMT 0803 M0	LT 3000	4	-	LT 080		p. 285	M0003405
RDMT 1003 M0	LT 3000	5	-	-		p. 286	M0002224
RDMT 10T3 M0	LT 3000	5	-	LT 100		p. 286	M0002225
RDMT 1204 M0	LT 3000	6	-	LT 120		p. 287	M0002226
RDMT 12T3 M0	LT 3000	6	-	-		p. 287	M0002227
RDMT 1604 M0	LT 3000	8	-	LT 160		p. 288	M0003407

ALPHA

DESIGNATION	GRADE	RADIUS (mm)	CUTTING EDGES	CUTTER LINE	MATERIAL RECOMMENDATION	CUTTING DATA	CATALOG #
RDMT 0602 M0	LT 30	3	-	LT 060		p. 283	M0000035
RDMT 0702 M0	LT 30	3.5	-	LT 070		p. 284	M0001882
RDMT 0803 M0	LT 30	4	-	LT 080		p. 285	M0000037
RDMT 1003 M0	LT 30	5	-	-		p. 286	M0001875
RDMT 10T3 M0	LT 30	5	-	LT 100		p. 286	M0000038
RDMT 1204 M0	LT 30	6	-	LT 120		p. 287	M0000039
RDMT 12T3 M0	LT 30	6	-	-		p. 287	M0001876
RDMT 1604 M0	LT 30	8	-	LT 160		p. 288	M0001881

R D M W



MAGIA

DESIGNATION	GRADE	RADIUS (mm)	CUTTING EDGES	CUTTER LINE	MATERIAL RECOMMENDATION	CUTTING DATA	CATALOG #
RDMW 1003 M0	LT 3000	5	-	-		p. 289	M0004424
RDMW 10T3 M0	LT 3000	5	-	LT 100		p. 289	M0002228
RDMW 1204 M0	LT 3000	6	-	LT 120		p. 289	M0003408
RDMW 12T3 M0	LT 3000	6	-	-		p. 289	M0004425

ALPHA

DESIGNATION	GRADE	RADIUS (mm)	CUTTING EDGES	CUTTER LINE	MATERIAL RECOMMENDATION	CUTTING DATA	CATALOG #
RDMW 1003 M0	LT 30	5	-	-		p. 289	M0004452
RDMW 10T3 M0	LT 30	5	-	LT 100		p. 289	M0001550
RDMW 1204 M0	LT 30	6	-	LT 120		p. 289	M0001551
RDMW 12T3 M0	LT 30	6	-	-		p. 289	M0004453

R D M X



MAGIA

DESIGNATION	GRADE	RADIUS (mm)	CUTTING EDGES	CUTTER LINE	MATERIAL RECOMMENDATION	CUTTING DATA	CATALOG #
RDMX 1003 M0	LT 3000	5	-	-		p. 286	M0004426
RDMX 10T3 M0	LT 3000	5	-	LT 100		p. 286	M0003409
RDMX 1204 M0	LT 3000	6	-	LT 120		p. 287	M0003410
RDMX 12T3 M0	LT 3000	6	-	-		p. 287	M0004427

ALPHA

DESIGNATION	GRADE	RADIUS (mm)	CUTTING EDGES	CUTTER LINE	MATERIAL RECOMMENDATION	CUTTING DATA	CATALOG #
RDMX 1003 M0	LT 30	5	-	-		p. 286	M0004454
RDMX 10T3 M0	LT 30	5	-	LT 100		p. 286	M0001552
RDMX 1204 M0	LT 30	6	-	LT 120		p. 287	M0001553
RDMX 12T3 M0	LT 30	6	-	-		p. 287	M0004455

MATERIAL GROUP

- STEEL
- STAINLESS STEEL
- CAST IRON
- HIGH TEMP ALLOYS
- HARDENED MATERIAL
- ALU(>8%Si)

COOLANT



p. 357

ORDERING EXAMPLE

QUANTITY 10 PIECES
 DESIGNATION + GRADE APKT 060204 PDTR LT 3000
 CATALOG NUMBER M0004026

TECHNICAL SECTION



p. 366 - 376

MATERIAL GROUP

- STEEL
- STAINLESS STEEL
- CAST IRON
- HIGH TEMP ALLOYS
- HARDENED MATERIAL
- ALU(>8%Si)

COOLANT



p. 357

ORDERING EXAMPLE

QUANTITY 10 PIECES
 DESIGNATION + GRADE APKT 060204 PDTR LT 3000
 CATALOG NUMBER M0004026

TECHNICAL SECTION



p. 366 - 376

CUTTERS RD..

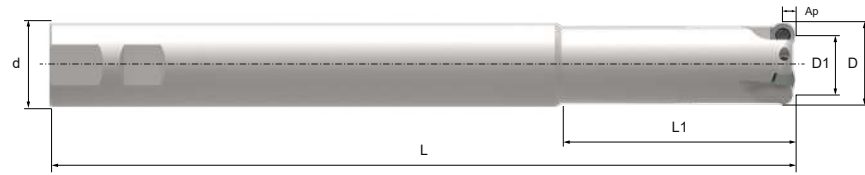

END MILL - RD.. 0602 M0

DESIGNATION	D	D1	d	L	L1	Ap	Z	α	CATALOG #
LT 060 WL-W-D012/2	12	6	16	150	25	3	2	7	M2003321
LT 060 WL-W-D016/2	16	10	16	150	25	3	2	6	M2000676
LT 060 WL-W-D020/3	20	14	20	180	60	3	3	4.5	M2000677
LT 060 WL-W-D025/3	25	19	25	180	80	3	3	4	M2000678

SCREW M2001416
KEY M2002912

END MILL - RD.. 0702 M0

DESIGNATION	D	D1	d	L	L1	Ap	Z	α	CATALOG #
LT 070 WL-W-D016/2	16	9	16	150	25	3.5	2	6	M2003336
LT 070 WL-W-D020/3	20	13	20	180	60	3.5	3	4.5	M2003337
LT 070 WL-W-D025/4	25	18	25	180	60	3.5	4	4	M2003339

SCREW M2001416
KEY M2002912

END MILL - RD.. 0803 M0

DESIGNATION	D	D1	d	L	L1	Ap	Z	α	CATALOG #
LT 080 WL-W-D016/2	16	8	16	150	25	4	2	12	M2003322
LT 080 WL-W-D020/2	20	12	20	180	42	5	2	12	M2000679
LT 080 WL-W-D025/3	25	17	25	180	60	5	3	8	M2000680
LT 080 WL-W-D032/3	32	24	32	180	80	5	3	5	M2000681

SCREW M2004402
KEY M2000601

END MILL - RD.. 10T3 M0

DESIGNATION	D	D1	d	L	L1	Ap	Z	α	CATALOG #
LT 100 WL-W-D020/2	20	10	20	180	25	5	2	12	M2000683
LT 100 WL-W-D025/3	25	15	25	180	60	5	3	8	M2000684
LT 100 WL-W-D032/3	32	22	32	180	80	5	3	5	M2000685

SCREW M2000597
KEY M2000602

END MILL - RD.. 1204 M0

DESIGNATION	D	D1	d	L	L1	Ap	Z	α	CATALOG #
LT 120 WL-W-D032/3	32	20	32	170	60	6	3	5	M2003323
LT 120 WL-W-D040/4	40	28	32	170	110	6	4	7	M2000687

SCREW M2000597
KEY M2000602

CUTTERS RD..

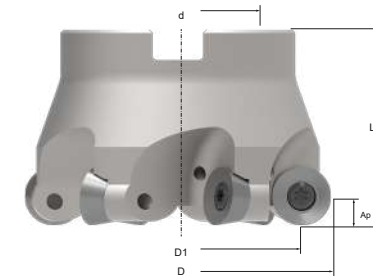

SHELL MILL - RD.. 1204 M0

DESIGNATION	D	D1	d	L	Ap	Z	α	CATALOG #
LT 120 M-W-D040/4	40	28	16	40	6	4	7	M2000691
LT 120 M-W-D050/4	50	38	22	50	6	4	5	M2001780
LT 120 M-W-D063/5	63	51	22	50	6	5	3.5	M2000689
LT 120 M-W-D080/6	80	68	27	50	6	6	2.5	M2000690
LT 120 M-W-D100/7	100	88	32	50	6	7	2	M2000688

SCREW M2000597
KEY M2000602

SHELL MILL - RD.. 1604 M0

DESIGNATION	D	D1	d	L	Ap	Z	α	CATALOG #
LT 160 M-W-D050/4	50	34	22	50	8	4	5	M2003331
LT 160 M-W-D063/5	63	47	22	50	8	5	3.5	M2003332
LT 160 M-W-D080/6	80	64	27	50	8	6	2.5	M2003333
LT 160 M-W-D100/7	100	84	32	50	8	7	2	M2003334
LT 160 M-W-D125/8	125	109	40	63	8	8	1	M2003335

SCREW M2000599
KEY M2000603

R X M T



MAGIA PRO

DESIGNATION	GRADE	RADIUS (mm)	CUTTING EDGES	CUTTER LINE	MATERIAL RECOMMENDATION	CUTTING DATA	CATALOG #
RXMT 10T3 M0	LT 3130	5	4	LT 101		p. 317	M0004476
RXMT 1204 M0	LT 3130	6	4	LT 121		p. 317	M0004477

MAGIA

DESIGNATION	GRADE	RADIUS (mm)	CUTTING EDGES	CUTTER LINE	MATERIAL RECOMMENDATION	CUTTING DATA	CATALOG #
RXMT 10T3 M0	LT 3000	5	4	LT 101		p. 286	M0004171
RXMT 1204 M0	LT 3000	6	4	LT 121		p. 287	M0004366

R X M W



MAGIA PRO

DESIGNATION	GRADE	RADIUS (mm)	CUTTING EDGES	CUTTER LINE	MATERIAL RECOMMENDATION	CUTTING DATA	CATALOG #
RXMW 10T3 M0	LT 3130	5	4	LT 101		p. 318	M0004478
RXMW 1204 M0	LT 3130	6	4	LT 121		p. 318	M0004479

MAGIA

DESIGNATION	GRADE	RADIUS (mm)	CUTTING EDGES	CUTTER LINE	MATERIAL RECOMMENDATION	CUTTING DATA	CATALOG #
RXMW 10T3 M0	LT 3000	5	4	LT 101		p. 289	M0004371
RXMW 1204 M0	LT 3000	6	4	LT 121		p. 289	M0004375

R X M X



MAGIA PRO

DESIGNATION	GRADE	RADIUS (mm)	CUTTING EDGES	CUTTER LINE	MATERIAL RECOMMENDATION	CUTTING DATA	CATALOG #
RXMX 10T3 M0	LT 3130	5	4	LT 101		p. 319	M0004480
RXMX1204 M0	LT 3130	6	4	LT 121		p. 319	M0004481

MAGIA

DESIGNATION	GRADE	RADIUS (mm)	CUTTING EDGES	CUTTER LINE	MATERIAL RECOMMENDATION	CUTTING DATA	CATALOG #
RXMX 10T3 M0	LT 3000	5	4	LT 101		p. 286	M0004373
RXMX1204 M0	LT 3000	6	4	LT 121		p. 287	M0004377

MATERIAL GROUP

- STEEL
- STAINLESS STEEL
- CAST IRON
- HIGH TEMP ALLOYS
- HARDENED MATERIAL
- ALU(>8%Si)

COOLANT



p. 357

ORDERING EXAMPLE

QUANTITY 10 PIECES
 DESIGNATION + GRADE APKT 060204 PDTR LT 3000
 CATALOG NUMBER M0004026

TECHNICAL SECTION



p. 366 - 376

MATERIAL GROUP

- STEEL
- STAINLESS STEEL
- CAST IRON
- HIGH TEMP ALLOYS
- HARDENED MATERIAL
- ALU(>8%Si)

COOLANT



p. 357

ORDERING EXAMPLE

QUANTITY 10 PIECES
 DESIGNATION + GRADE APKT 060204 PDTR LT 3000
 CATALOG NUMBER M0004026

TECHNICAL SECTION



p. 366 - 376

CUTTERS RX..

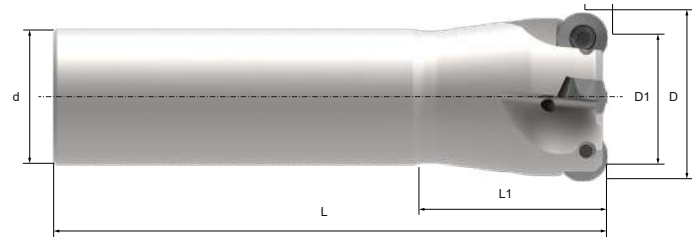

END MILL RX.. - 10T3 M0

DESIGNATION	D	D1	d	L	L1	Ap	Z	α	CATALOG #
LT 101 C-W-D025/3	25	15	25	117	60	5	3	10.0	M2001562
LT 101 C-W-D032/4	32	22	32	131	70	5	4	8.5	M2001563
LT 101 CL-W-D032/3	32	22	32	181	70	5	3	8.5	M2001564
LT 101 W-W-D025/3	25	15	25	92	35	5	3	10.0	M2001565
LT 101 W-W-D032/4	32	22	32	101	40	5	4	8.5	M2001566
LT 101 WL-W-D032/3	32	22	32	181	120	5	3	8.5	M2001567

SCREW M2003786
KEY M2000602

END MILL RX.. - 1204 M0

DESIGNATION	D	D1	d	L	L1	Ap	Z	α	CATALOG #
LT 121 C-W-D040/4	40	28.0	40	141	70	6	4	7.5	M2001853
LT 121 W-W-D040/4	40	28.0	40	111	40	6	4	7.5	M2001854

SCREW M2000597
KEY M2000602

CUTTERS RX..

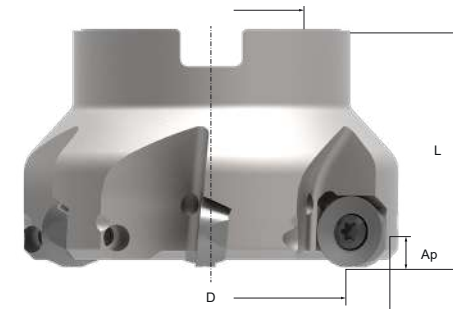

SHELL MILL - RX.. 10T3 M0

DESIGNATION	D	D1	d	L	Ap	Z	α	CATALOG #
LT 101 M-W-D040/5	40	30	16	40	5	5	5.5	M2003442
LT 101 M-W-D050/6	50	40	22	40	5	6	4.0	M2001568
LT 101 M-W-D052/5	52	42	22	40	5	5	4.0	M2001569
LT 101 M-W-D052/6	52	42	22	40	5	6	4.0	M2001570
LT 101 M-W-D063/7	63	53	22	40	5	7	3.0	M2001571
LT 101 M-W-D066/6	66	56	22	40	5	6	2.6	M2001572
LT 101 M-W-D066/7	66	56	22	40	5	7	2.6	M2001573

SCREW M2003786
KEY M2000602

SHELL MILL - RX.. 1204 M0

DESIGNATION	D	D1	d	L	Ap	Z	α	CATALOG #
LT 121 M-W-D040/4	40	28.0	16	40	6	4	7.5	M2001855
LT 121 M-W-D050/5	50	38.0	22	40	6	5	5.0	M2001856
LT 121 M-W-D052/5	52	40.0	22	40	6	5	5.0	M2001857
LT 121 M-W-D063/7	63	51.0	22	40	6	7	3.0	M2001858
LT 121 M-W-D066/6	66	54.0	22	40	6	6	3.0	M2001859
LT 121 M-W-D066/7	66	54.0	22	40	6	7	3.0	M2001860
LT 121 M-W-D080/7	80	68.0	27	50	6	7	2.5	M2001861
LT 121 M-W-D080/9	80	68.0	27	50	6	9	2.5	M2001862

SCREW M2000597
KEY M2000602

CUTTERS RX..

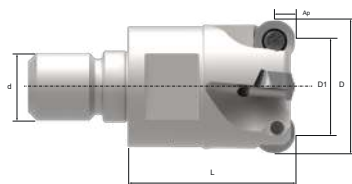

SCREW COUPLING - RX.. 10T3 M0

DESIGNATION	D	D1	d	L1	Ap	Z	α	CATALOG #
LT 101 S-W-D025/3	25	15	M12	35	5	3	10.0	M2001574
LT 101 S-W-D032/3	32	22	M16	35	5	3	8.5	M2001575
LT 101 S-W-D032/4	32	22	M16	35	5	4	8.5	M2001576

SCREW M2003786
KEY M2000602

SCREW COUPLING - RX.. 1204 M0

DESIGNATION	D	D1	d	L1	Ap	Z	α	CATALOG #
LT 121 S-W-D040/4	40	28.0	M16	40	6	4	7.5	M2001863

SCREW M2000597
KEY M2000602

SLOT MILLING

T-SLOTTING WITH MULTI-MAT™

High quality cutters for T-slot milling operations combined with our winning MULTI-MAT™ grade inserts.

- Reduce costs of cutting tools with our SPMT MULTI-MAT™ inserts with four cutting edges per insert
- Approach angle $k = 90^\circ$
- Soft cutting due to the positive geometry
- Internal coolant supply
- For slotting according to DIN 650 norms

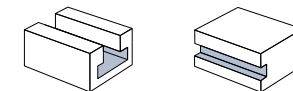

SPMT



MAGIA

DESIGNATION	GRADE	RADIUS (mm)	CUTTING EDGES	CUTTER LINE	MATERIAL RECOMMENDATION	CUTTING DATA	CATALOG #
SPMT 060304 TN	LT 3000	0.40	4	LT 400		p. 301	M0003416
SPMT 09T308 TN	LT 3000	0.80	4	LT 400		p. 302	M0003417
SPMT 120408 TN	LT 3000	0.80	4	LT 400		p. 303	M0003419

ALPHA

DESIGNATION	GRADE	RADIUS (mm)	CUTTING EDGES	CUTTER LINE	MATERIAL RECOMMENDATION	CUTTING DATA	CATALOG #
SPMT 060304 TN	LT 30	0.40	4	LT 400		p. 301	M0003100
SPMT 09T308 TN	LT 30	0.80	4	LT 400		p. 302	M0003063
SPMT 120408 TN	LT 30	0.80	4	LT 400		p. 303	M0003105

CUTTERS SPMT - SLOT MILLING

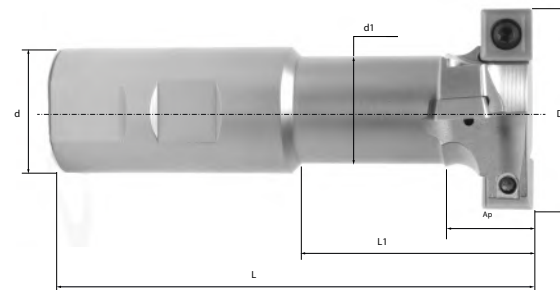

END MILL - SPMT 060304

DESIGNATION	D	d1	d	L	L1	Ap	Z	Z _(EFF)	CATALOG #
LT 400-06 W-W-D021/1	21	11 - 12	16	76	26	9	2	1	M2004218
LT 400-06 W-W-D025/2	25	12 - 13	16	82	31	11	4	2	M2004219

SCREW KEY M2002181
M2000601

END MILL - SPMT 09T308

DESIGNATION	D	d1	d	L	L1	Ap	Z	Z _(EFF)	CATALOG #
LT 400-09 W-W-D032/2	32	17 - 18	20	88	38	14	4	2	M2004220
LT 400-09 W-W-D040/2	40	21 - 22	25	108	50	17	4	2	M2004221

SCREW KEY M2001418
M2000602

END MILL - SPMT 120408

DESIGNATION	D	d1	d	L	L1	Ap	Z	Z _(EFF)	CATALOG #
LT 400-12 W-W-D050/2	50	27 - 28	32	120	56	22	4	2	M2004222

SCREW KEY M2000599
M2000603

MATERIAL GROUP

- STEEL
- STAINLESS STEEL
- CAST IRON
- HIGH TEMP ALLOYS
- HARDENED MATERIAL
- ALU(>8%SI)

COOLANT



p. 357

ORDERING EXAMPLE

QUANTITY 10 PIECES
DESIGNATION + GRADE APKT 060204 PDTR LT 3000
CATALOG NUMBER M0004026

TECHNICAL SECTION



p. 366 - 376

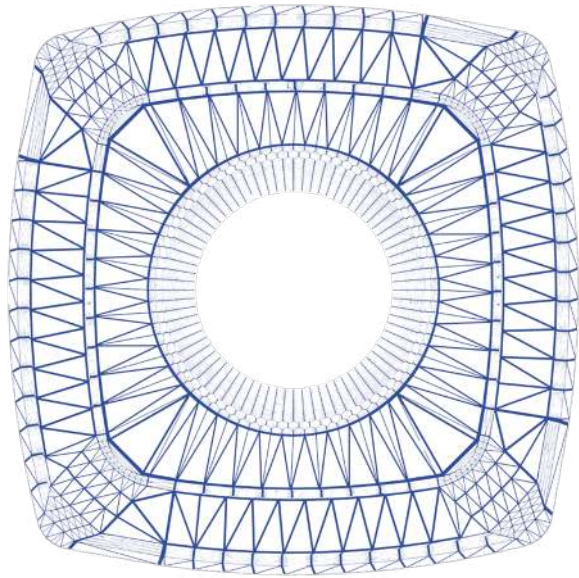

EFFICIENCY



ALU
MILLING

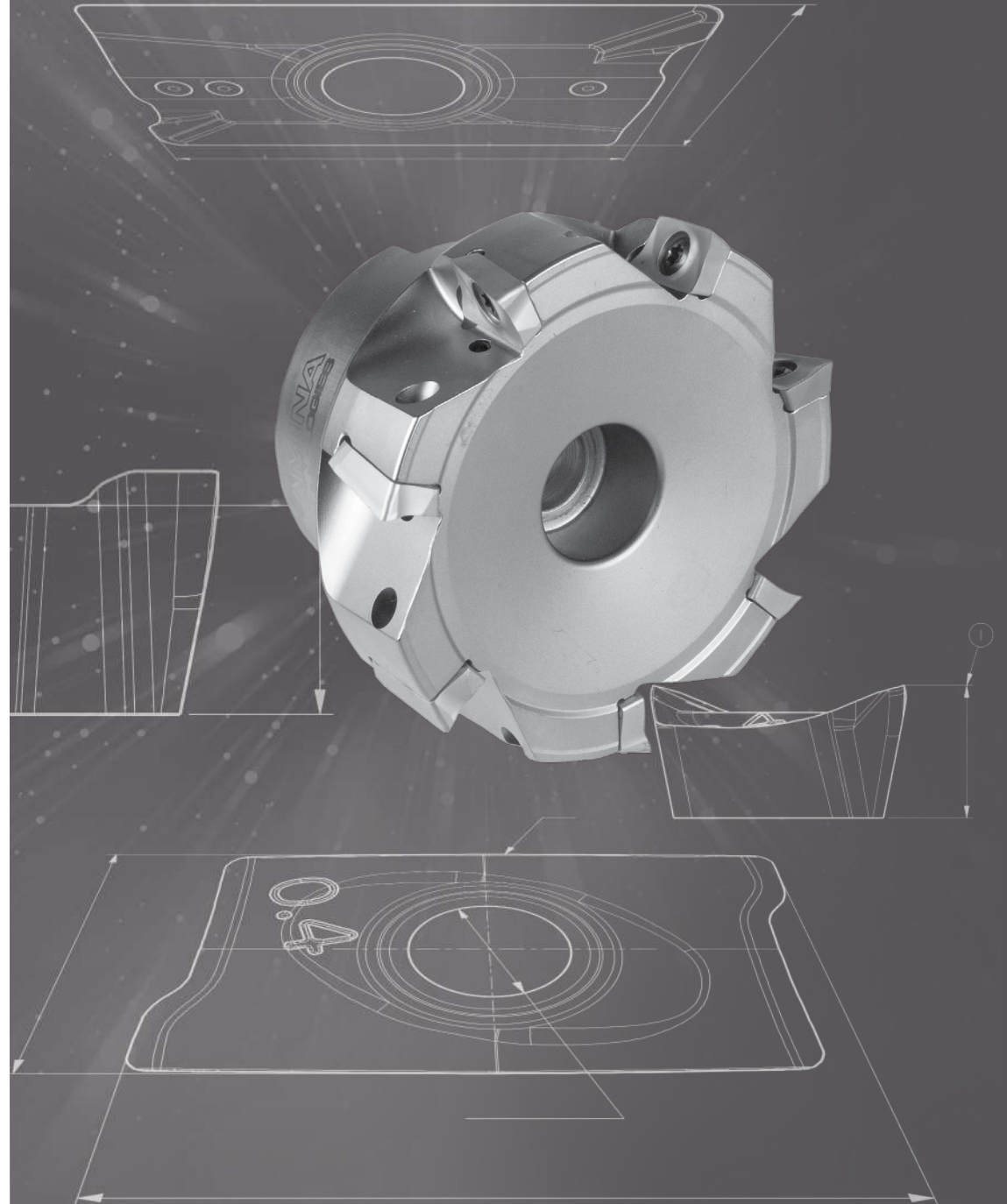

ALU
MILLING

LT 05 ALUMINIUM GRADE

Highly positive inserts with a unique coating. Ideal for 90° shoulder milling and 45° face milling of aluminium.

- Dedicated for aluminum and other non-ferrous materials
- Low friction
- High resistance to built up edge
- Extremely long tool life

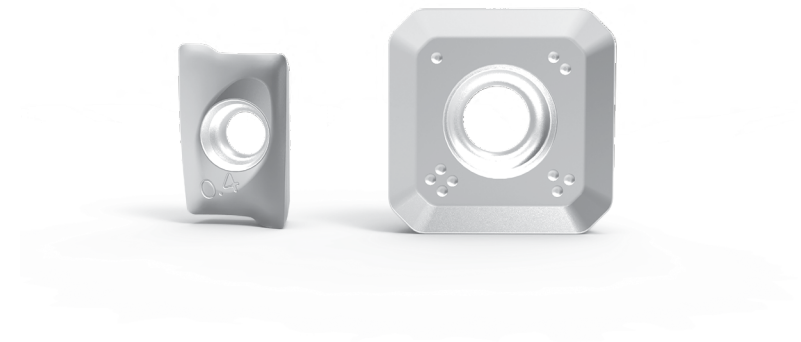

APGT



DESIGNATION	GRADE	RADIUS (mm)	CUTTING EDGES	CUTTER LINE	MATERIAL RECOMMENDATION	CUTTING DATA	CATALOG #
APGT 100304 PDER - ALU	LT 05	0.4	2	LT 741	■	p. 324	M0003089
APGT 160408 PDER - ALU	LT 05	0.8	2	LT 731		P. 324	M0001010

CUTTERS APGT

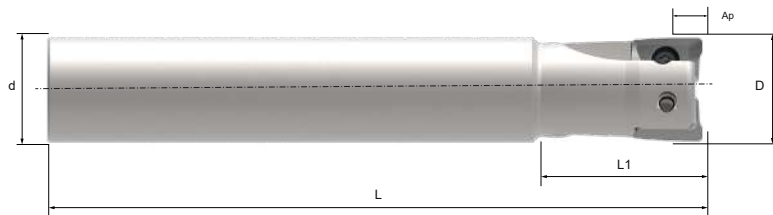

END MILL - APGT 100304 PDER

DESIGNATION	D	d	L	L1	Ap	Z	α	CATALOG #
LT 741 C-W-D016/2	16	16	100	25	9	2	12	M2002806
LT 741 CL-W-D016/2	16	16	150	35	9	2	12	M2002817
LT 741 C-W-D018/2	18	20	100	30	9	2	12	M2002807
LT 741 C-W-D020/3	20	20	100	30	9	3	7	M2002808
LT 741 CL-W-D020/3	20	20	150	35	9	3	7	M2002818
LT 741 C-W-D022/3	22	20	100	30	9	3	7	M2002809
LT 741 C-W-D025/3	25	25	120	30	9	3	5	M2002810
LT 741 CL-W-D025/4	25	25	200	40	9	4	5	M2002819
LT 741 C-W-D025/4	25	25	120	30	9	4	5	M2002811
LT 741 C-W-D028/4	28	25	120	30	9	4	2	M2002812
LT 741 C-W-D030/4	30	25	120	30	9	4	2	M2002813
LT 741 W-W-D032/5	32	32	120	30	9	5	3	M2002814
LT 741 WL-W-D032/4	32	32	200	40	9	4	3	M2002820

SCREW KEY M2002181
M2000601

CUTTERS APGT

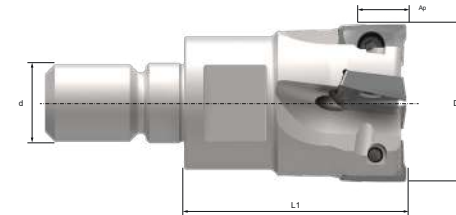

SCREW COUPLING - APGT 100304 PDER

DESIGNATION	D	d	L1	Ap	Z	α	CATALOG #
LT 741 S-W-D016/2	16	M8	25	9	2	10	M2002962
LT 741 S-W-D020/3	20	M10	30	9	3	7	M2002963
LT 741 S-W-D025/4	25	M12	35	9	4	5	M2002964

SCREW KEY M2002181
M2000601

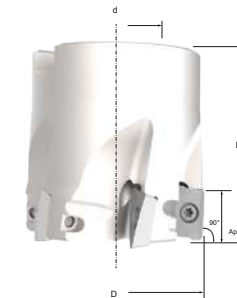

SHELL MILL - APGT 100304 PDER

DESIGNATION	D	d	L	Ap	Z	α	CATALOG #
LT 741 M-W-D040/6	40	16	40	9	6	2.5	M2002798
LT 741 M-W-D050/7	50	22	40	9	7	2.2	M2002799
LT 741 M-W-D063/8	63	22	40	9	8	1.8	M2002800
LT 741 M-W-D080/11*	80	27	50	9	11	1.4	M2002801

*On Request

SCREW KEY M2002181
M2000601

MATERIAL GROUP

- STEEL
- STAINLESS STEEL
- CAST IRON
- HIGH TEMP ALLOYS
- HARDENED MATERIAL
- ALU(>8%Si)

COOLANT



p. 357

ORDERING EXAMPLE

QUANTITY 10 PIECES
DESIGNATION + GRADE APKT 060204 PDTR LT 3000
CATALOG NUMBER M0004026

TECHNICAL SECTION



p. 366 - 376

CUTTERS APGT

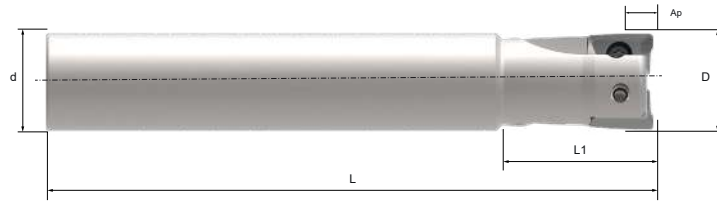

END MILL - APGT 1604

DESIGNATION	D	d	L	L1	Ap	Z	α	CATALOG #
LT 731 W-W-D025/2	25	25	100	44	15	2	5	M2002966
LT 731 WL-W-D025/2	25	25	220	90	15	2	5	M2002965
LT 731 W-W-D032/3	32	32	110	50	15	3	3	M2002968
LT 731 WL-W-D032/3	32	32	220	90	15	3	3	M2002967
LT 731 W-W-D040/4	40	32	115	50	15	4	2.5	M2002970
LT 731 WL-W-D040/4	40	32	220	90	15	4	2.5	M2002969

SCREW M2000597
KEY M2000602

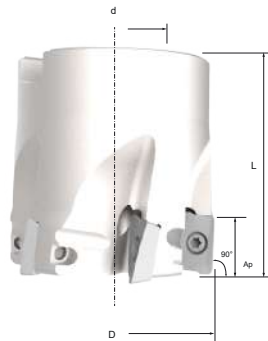

SHELL MILL - APGT 160408 PDTR

DESIGNATION	D	d	L	Ap	Z	α	CATALOG #
LT 731 M-W-D040/4	40	16	40	15	4	2.5	M2002971
LT 731 M-W-D050/5	50	22	40	15	5	2.2	M2002972
LT 731 M-W-D063/6	63	22	40	15	6	1.8	M2002973
LT 731 M-W-D080/7	80	27	50	15	7	1.4	M2002974
LT 731 M-W-D100/8	100	32	50	15	8	1.1	M2002975
LT 731 M-W-D125/9	125	40	63	15	9	0.8	M2002976
LT 731 M-D-D160/10*	160	40	63	15	10	N/A	M2002977

SEGT



DESIGNATION	GRADE	RADIUS (mm)	CUTTING EDGES	CUTTER LINE	MATERIAL RECOMMENDATION	CUTTING DATA	CATALOG #
SEGT 1204 AFEN - ALU	LT 05	0.84	4	LT 600		p. 324	M0001008

CUTTERS SEGT

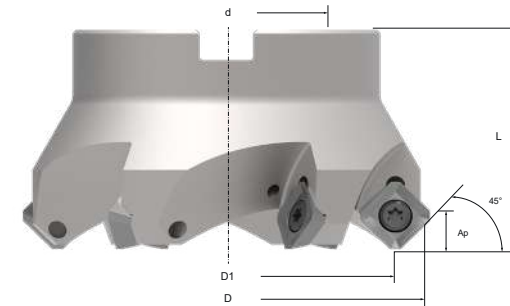

SHELL MILL - SEGT 1204 AFEN-ALU

DESIGNATION	D	D1	d	L	Ap	Z	α	CATALOG #
LT 600 M-W-D040/3	53	40	16	40	6	3	10	M2000546
LT 600 M-W-D050/4	63	50	22	48	6	4	8	M2000547
LT 600 M-W-D063/5	76	63	22	48	6	5	6	M2000548
LT 600 M-W-D080/6	93	80	27	50	6	6	4.5	M2000549
LT 600 M-W-D100/6	113	100	32	50	6	6	3.5	M2000550
LT 600 M-W-D125/7	138	125	40	63	6	7	3	M2000551
LT 600 M-D-D160/8	173	160	40	63	6	8	2.2	M2000552

SCREW M2000599
KEY M2000603

MATERIAL GROUP

■ STEEL	■ HIGH TEMP ALLOYS
■ STAINLESS STEEL	■ HARDENED MATERIAL
■ CAST IRON	■ ALU (>8%Si)

COOLANT



ORDERING EXAMPLE

QUANTITY	10 PIECES
DESIGNATION + GRADE	APKT 060204 PDTR LT 3000
CATALOG NUMBER	M0004026

TECHNICAL SECTION



MULTI-MAT™
... and life becomes easy



SOLID CARBIDE END MILLS

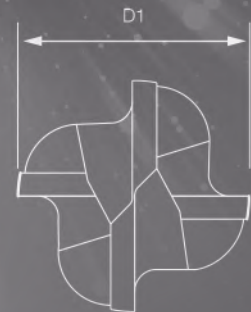
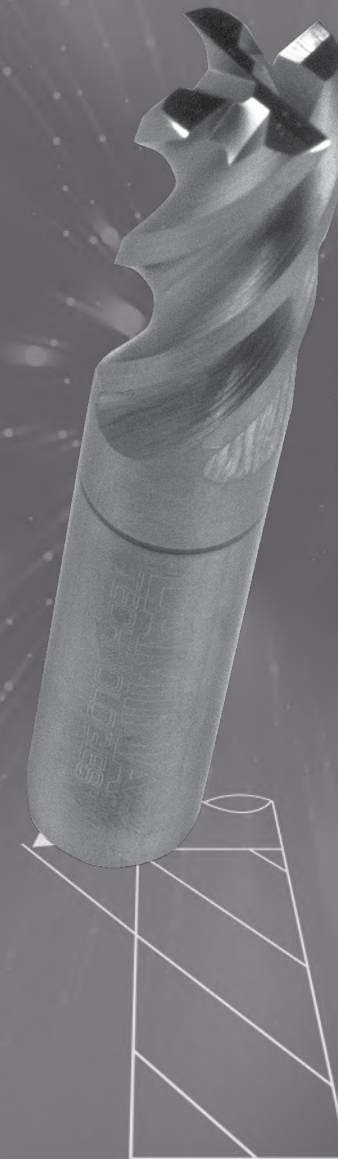

SOLID
END MILLS

MAGIA

LT 4000 PREMIUM MULTI-MAT™ GRADE FOR SOLID CARBIDE END MILLS

MAGIA LT 4000 is the latest, state-of-the-art PVD grade using high density plasma to create nano-structured PVD coatings with incredible properties.

With this new PVD technology in combination with our exclusive substrate and edge preparation, MAGIA Solid Carbide delivers increased toughness for the most extreme applications, higher reliability in lower cutting speeds with coolant which results in an extended application range.

Increased tool life due to reduced friction between the coating and the chips, and a harder coating composite that better resists abrasion.

We have achieved unprecedented tool life.

- Next generation MULTI-MAT™ Solid End Mills
- Increased toughness for extended application range
- Longer tool life through new and unique coating composition.
- New and exclusive ultra fine grained coating
- Exclusive edge preparation and pre-coating surface treatment
- Unique substrate



ALPHA

LT 40 EXCELLENT PERFORMANCE AT AN AFFORDABLE PRICE

Our general purpose Alpha line provide value and versatility at an attractive price.

Alpha Line is our standard, general usage product line. Our Alpha LT 40 grade for solid carbide end mills is designed to work in a wide variety of applications and workpiece materials. It is ideal for customers with pricing considerations while also expecting high



90° Z2

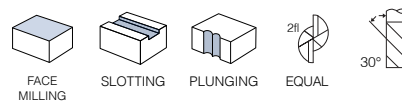
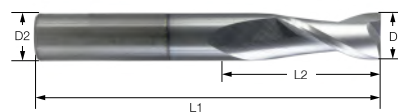

MAGIA

90° 2 FLUTE

DESIGNATION	GRADE	D1	D2	L1	L2	CATALOG #
E90 Z2 D00.2(03) L0.5(038)	LT 4000	0.2	3	38	0.5	M5003531
E90 Z2 D00.3(03) L0.8(038)	LT 4000	0.3	3	38	0.8	M5003532
E90 Z2 D00.4(03) L1.0(038)	LT 4000	0.4	3	38	1.0	M5003533
E90 Z2 D00.5(03) L1.2(038)	LT 4000	0.5	3	38	1.2	M5003534
E90 Z2 D00.6(03) L1.5(038)	LT 4000	0.6	3	38	1.5	M5003535
E90 Z2 D00.8(03) L2.0(038)	LT 4000	0.8	3	38	2	M5003536
E90 Z2 D01.0(03) L3.0(038)	LT 4000	1.0	3	38	3	M5003520
E90 Z2 D01.5(03) L5.0(038)	LT 4000	1.5	3	38	5	M5003537
E90 Z2 D02.0(03) L6.0(038)	LT 4000	2.0	3	38	6	M5003538
E90 Z2 D02.5(03) L7.0(038)	LT 4000	2.5	3	38	7	M5003539
E90 Z2 D03.0(03) L9.0(038)	LT 4000	3.0	3	38	9	M5003540
E90 Z2 D04.0(04) L14.0(050)	LT 4000	4.0	4	50	14	M5003541
E90 Z2 D05.0(05) L16.0(050)	LT 4000	5.0	5	50	16	M5003542
E90 Z2 D06.0(06) L20.0(063)	LT 4000	6.0	6	63	20	M5003543
E90 Z2 D08.0(08) L20.0(063)	LT 4000	8.0	8	63	20	M5003544
E90 Z2 D10.0(10) L22.0(072)	LT 4000	10.0	10	72	22	M5003545
E90 Z2 D12.0(12) L26.0(075)	LT 4000	12.0	12	75	26	M5003546

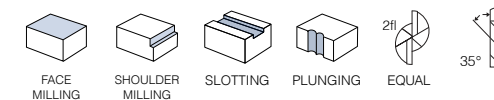

ALPHA

90° 2 FLUTE

DESIGNATION	GRADE	D1	D2	L1	L2	CATALOG #
E90 Z2 D01.0(04) L03.0(050)	LT 40	1	4	50	3	M5005500
E90 Z2 D01.5(04) L05.0(050)	LT 40	1.5	4	50	5	M5005501
E90 Z2 D02.0(04) L05.0(050)	LT 40	2	4	50	5	M5005502
E90 Z2 D02.5(04) L08.0(050)	LT 40	2.5	4	50	8	M5005503
E90 Z2 D03.0(04) L08.0(050)	LT 40	3	4	50	8	M5005504
E90 Z2 D04.0(04) L11.0(050)	LT 40	4	4	50	11	M5005505
E90 Z2 D05.0(06) L13.0(050)	LT 40	5	6	50	13	M5005506
E90 Z2 D06.0(06) L16.0(050)	LT 40	6	6	50	16	M5005507
E90 Z2 D08.0(08) L20.0(060)	LT 40	8	8	60	20	M5005508
E90 Z2 D10.0(10) L25.0(072)	LT 40	10	10	72	25	M5005509
E90 Z2 D12.0(12) L30.0(075)	LT 40	12	12	75	30	M5005510
E90 Z2 D16.0(16) L40.0(100)	LT 40	16	16	100	40	M5005511

90° Z3

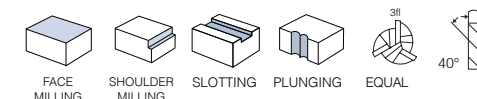
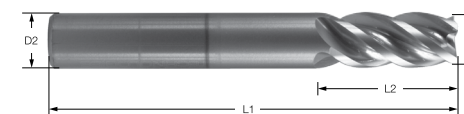

MAGIA

90° 3 FLUTE

DESIGNATION	GRADES	D1	D2	L1	L2	CATALOG #
E90 Z3 D03.0(06) L8.0(050)	LT 4000	3.0	6	50	8	M5003548
E90 Z3 D04.0(06) L11.0(050)	LT 4000	4.0	6	50	11	M5003549
E90 Z3 D05.0(06) L13.0(050)	LT 4000	5.0	6	50	13	M5003550
E90 Z3 D06.0(06) L16.0(050)	LT 4000	6.0	6	50	16	M5003551
E90 Z3 D08.0(08) L20.0(060)	LT 4000	8.0	8	60	20	M5003552
E90 Z3 D10.0(10) L25.0(072)	LT 4000	10.0	10	72	25	M5003553
E90 Z3 D12.0(12) L30.0(075)	LT 4000	12.0	12	75	30	M5003554

90° Z4

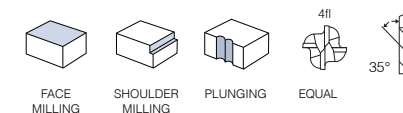
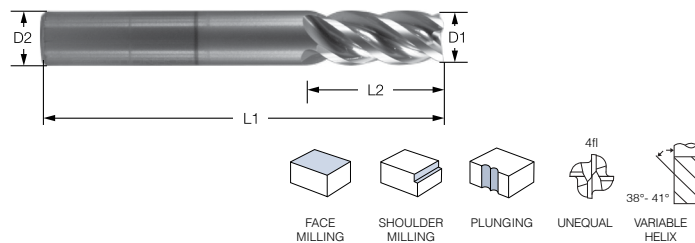

MAGIA

90° 4 FLUTE

DESIGNATION	GRADE	D1	D2	L1	L2	CATALOG #
E90 Z4 D01.0(04) L03.0(050)	LT 4000	1.0	4	50	3	M5003568
E90 Z4 D01.5(04) L05.0(050)	LT 4000	1.5	4	50	5	M5003569
E90 Z4 D02.0(04) L06.0(050)	LT 4000	2.0	4	50	6	M5003570
E90 Z4 D02.5(04) L08.0(050)	LT 4000	2.5	4	50	8	M5003571
E90 Z4 D03.0(06) L08.0(050)	LT 4000	3.0	6	50	8	M5003572
E90 Z4 D04.0(06) L11.0(050)	LT 4000	4.0	6	50	11	M5003573
E90 Z4 D05.0(06) L13.0(050)	LT 4000	5.0	6	50	13	M5003574
E90 Z4 D06.0(06) L16.0(050)	LT 4000	6.0	6	50	16	M5003575
E90 Z4 D08.0(08) L20.0(060)	LT 4000	8.0	8	60	20	M5003576
E90 Z4 D10.0(10) L22.0(072)	LT 4000	10.0	10	72	22	M5003577
E90 Z4 D12.0(12) L26.0(075)	LT 4000	12.0	12	75	26	M5003578
E90 Z4 D16.0(16) L38.0(100)	LT 4000	16.0	16	100	38	M5003579

ALPHA

90° 4 FLUTE, SHORT

DESIGNATION	GRADE	D1	D2	L1	L2	CATALOG #
E90 Z4 D01.0(04) L03.0(050)	LT 40	1	4	50	3	M5005512
E90 Z4 D01.5(04) L05.0(050)	LT 40	1.5	4	50	5	M5005513
E90 Z4 D02.0(04) L06.0(050)	LT 40	2	4	50	6	M5005514
E90 Z4 D02.5(04) L08.0(050)	LT 40	2.5	4	50	8	M5005515
E90 Z4 D03.0(04) L08.0(050)	LT 40	3	4	50	8	M5005516
E90 Z4 D04.0(04) L11.0(050)	LT 40	4	4	50	11	M5005517
E90 Z4 D05.0(06) L13.0(050)	LT 40	5	6	50	13	M5005518
E90 Z4 D06.0(06) L16.0(050)	LT 40	6	6	50	16	M5005519
E90 Z4 D08.0(08) L20.0(060)	LT 40	8	8	60	20	M5005520
E90 Z4 D10.0(10) L25.0(072)	LT 40	10	10	72	25	M5005521
E90 Z4 D12.0(12) L30.0(075)	LT 40	12	12	75	30	M5005522
E90 Z4 D16.0(16) L40.0(100)	LT 40	16	16	100	40	M5005523

90° Z4 L

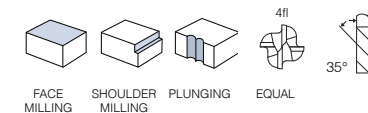
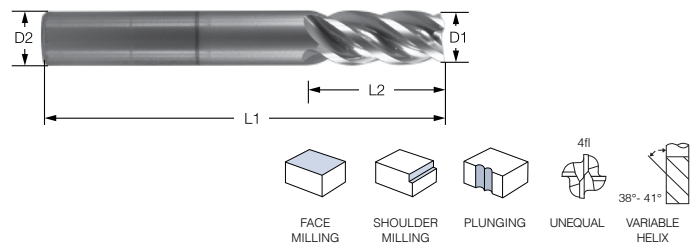

MAGIA

90° 4 FLUTE, LONG

DESIGNATION	GRADE	D1	D2	L1	L2	CATALOG #
E90 Z4 D03.0(06) L12.0(050)	LT 4000	3.0	6	50	12	M5003559
E90 Z4 D04.0(06) L16.0(055)	LT 4000	4.0	6	55	16	M5003560
E90 Z4 D05.0(06) L20.0(060)	LT 4000	5.0	6	60	20	M5003561
E90 Z4 D06.0(06) L24.0(065)	LT 4000	6.0	6	65	24	M5003562
E90 Z4 D08.0(08) L32.0(090)	LT 4000	8.0	8	90	32	M5003563
E90 Z4 D10.0(10) L40.0(100)	LT 4000	10.0	10	100	40	M5003564
E90 Z4 D12.0(12) L48.0(110)	LT 4000	12.0	12	110	48	M5003565
E90 Z4 D16.0(16) L64.0(160)	LT 4000	16.0	16	160	64	M5003566

ALPHA

90° 4 FLUTE, LONG

DESIGNATION	GRADE	D1	D2	L1	L2	CATALOG #
E90 Z4 D03.0(06) L12.0(070)	LT 40	3	6	70	12	M5005524
E90 Z4 D04.0(06) L15.0(070)	LT 40	4	6	70	15	M5005525
E90 Z4 D05.0(06) L20.0(080)	LT 40	5	6	80	20	M5005526
E90 Z4 D06.0(06) L20.0(080)	LT 40	6	6	80	20	M5005527
E90 Z4 D08.0(08) L25.0(100)	LT 40	8	8	100	25	M5005528
E90 Z4 D10.0(10) L30.0(100)	LT 40	10	10	100	30	M5005529
E90 Z4 D12.0(12) L40.0(110)	LT 40	12	12	110	40	M5005530
E90 Z4 D16.0(16) L50.0(140)	LT 40	16	16	140	50	M5005531

90° Z4 R

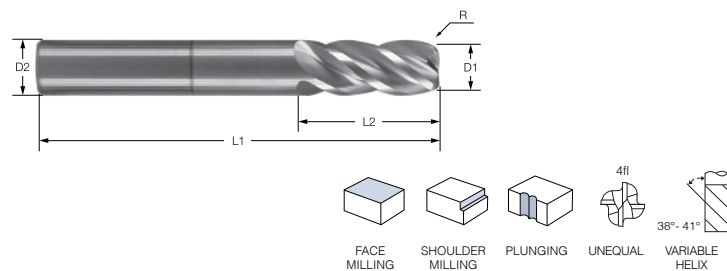

MAGIA

90° 4 FLUTE WITH RADIUS

DESIGNATION	GRADE	D1	D2	L1	L2	R	CATALOG #
E90 Z4 D03.0(06) L08.0(050) R0.5	LT 4000	3	6	50	8	0.5	M5003614
E90 Z4 D04.0(06) L11.0(050) R0.5	LT 4000	4	6	50	11	0.5	M5003615
E90 Z4 D05.0(06) L13.0(050) R0.5	LT 4000	5	6	50	13	0.5	M5003616
E90 Z4 D06.0(06) L16.0(050) R0.5	LT 4000	6	6	50	16	0.5	M5003617
E90 Z4 D08.0(08) L20.0(060) R0.5	LT 4000	8	8	60	20	0.5	M5003618
E90 Z4 D10.0(10) L22.0(072) R0.5	LT 4000	10	10	72	22	0.5	M5003619
E90 Z4 D12.0(12) L26.0(075) R0.5	LT 4000	12	12	75	26	0.5	M5003620
E90 Z4 D03.0(06) L08.0(050) R1.0	LT 4000	3	6	50	8	1.0	M5003623
E90 Z4 D04.0(06) L11.0(050) R1.0	LT 4000	4	6	50	11	1.0	M5003624
E90 Z4 D05.0(06) L13.0(050) R1.0	LT 4000	5	6	50	13	1.0	M5003625
E90 Z4 D06.0(06) L16.0(050) R1.0	LT 4000	6	6	50	16	1.0	M5003626
E90 Z4 D08.0(08) L20.0(060) R1.0	LT 4000	8	8	60	20	1.0	M5003627
E90 Z4 D10.0(10) L22.0(072) R1.0	LT 4000	10	10	72	22	1.0	M5003628
E90 Z4 D12.0(12) L26.0(075) R1.0	LT 4000	12	12	75	26	1.0	M5003629
E90 Z4 D06.0(06) L16.0(050) R2.0	LT 4000	6	6	50	16	2.0	M5003632
E90 Z4 D08.0(08) L20.0(060) R2.0	LT 4000	8	8	60	20	2.0	M5003633
E90 Z4 D10.0(10) L22.0(072) R2.0	LT 4000	10	10	72	22	2.0	M5003634
E90 Z4 D12.0(12) L26.0(075) R2.0	LT 4000	12	12	75	26	2.0	M5003635

90° Z4 RL

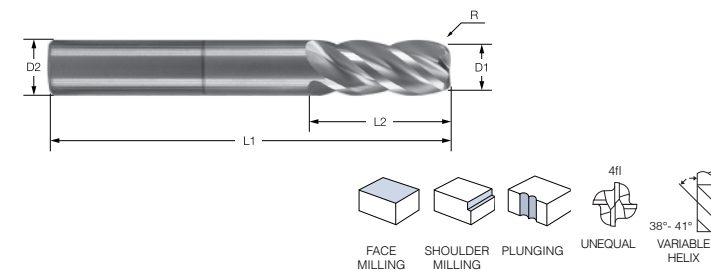

MAGIA

90° 4 FLUTE WITH RADIUS, LONG

DESIGNATION	GRADE	D1	D2	L1	L2	R	CATALOG #
E90 Z4 D08.0(08) L32.0(090) R0.5	LT 4000	8	8	90	32	0.5	M5003638
E90 Z4 D10.0(10) L40.0(100) R0.5	LT 4000	10	10	100	40	0.5	M5003639
E90 Z4 D12.0(12) L48.0(110) R0.5	LT 4000	12	12	110	48	0.5	M5003640

EBN

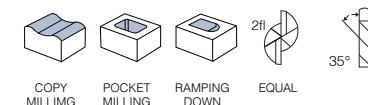
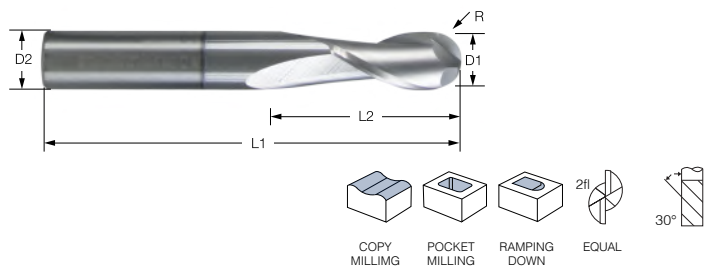

MAGIA

BALL NOSE, 2 FLUTE

DESIGNATION	GRADE	D1	D2	L1	L2	R	CATALOG #
EBN Z2 D01.0(03) L03.0(038) R0.50	LT 4000	1	3	38	3	0.50	M5003587
EBN Z2 D01.5(03) L05.0(038) R0.75	LT 4000	1.5	3	38	5	0.75	M5003588
EBN Z2 D02.0(03) L06.0(038) R1.00	LT 4000	2	3	38	6	1.00	M5003589
EBN Z2 D02.5(03) L07.0(038) R1.25	LT 4000	2.5	3	38	7	1.25	M5003590
EBN Z2 D03.0(03) L09.0(038) R1.50	LT 4000	3	3	38	9	1.50	M5003591
EBN Z2 D04.0(04) L14.0(050) R2.00	LT 4000	4	4	50	14	2.00	M5003592
EBN Z2 D05.0(05) L16.0(050) R2.50	LT 4000	5	5	50	16	2.50	M5003593
EBN Z2 D06.0(06) L20.0(063) R3.00	LT 4000	6	6	63	20	3.00	M5003594
EBN Z2 D08.0(08) L20.0(063) R4.00	LT 4000	8	8	63	20	4.00	M5003595
EBN Z2 D10.0(10) L22.0(072) R5.00	LT 4000	10	10	72	22	5.00	M5003596
EBN Z2 D12.0(12) L26.0(075) R6.00	LT 4000	12	12	75	26	6.00	M5003597

ALPHA

BALL NOSE, 2 FLUTE

DESIGNATION	GRADE	D1	D2	L1	L2	R	CATALOG #
EBN Z2 D01.0(04) L02.0(050)	LT 40	1	4	50	2	0.50	M5005532
EBN Z2 D01.5(04) L03.0(050)	LT 40	1.5	4	50	3	0.75	M5005533
EBN Z2 D02.0(04) L04.0(050)	LT 40	2	4	50	4	1.00	M5005534
EBN Z2 D02.5(04) L05.0(050)	LT 40	2.5	4	50	5	1.25	M5005535
EBN Z2 D03.0(04) L06.0(050)	LT 40	3	4	50	6	1.50	M5005536
EBN Z2 D04.0(04) L08.0(050)	LT 40	4	4	50	8	2.00	M5005537
EBN Z2 D05.0(06) L10.0(050)	LT 40	5	6	50	10	2.50	M5005538
EBN Z2 D06.0(06) L12.0(050)	LT 40	6	6	50	12	3.00	M5005539
EBN Z2 D08.0(08) L14.0(060)	LT 40	8	8	60	14	4.00	M5005540
EBN Z2 D10.0(10) L18.0(072)	LT 40	10	10	72	18	5.00	M5005541
EBN Z2 D12.0(12) L22.0(075)	LT 40	12	12	75	22	6.00	M5005542
EBN Z2 D16.0(16) L30.0(100)	LT 40	16	16	100	30	8.00	M5005543

ERO Z3

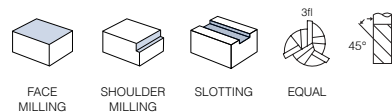

MAGIA ROUGHER, 3 FLUTE

DESIGNATION	GRADE	D1	D2	L1	L2	CATALOG #
ERO Z3 D04.0(06) L11.0(057)	LT 4000	4	6	57	11	M5003607

ERO Z4

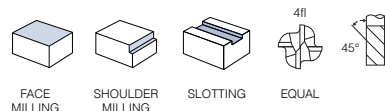

MAGIA ROUGHER, 4 FLUTE

DESIGNATION	GRADE	D1	D2	L1	L2	CATALOG #
ERO Z4 D05.0(06) L13.0(057)	LT 4000	5	6	57	13	M5003608
ERO Z4 D06.0(06) L13.0(057)	LT 4000	6	6	57	13	M5003609
ERO Z4 D08.0(08) L19.0(063)	LT 4000	8	8	63	19	M5003610
ERO Z4 D10.0(10) L22.0(072)	LT 4000	10	10	72	22	M5003611
ERO Z4 D12.0(12) L26.0(083)	LT 4000	12	12	83	26	M5003612

EHF Z4

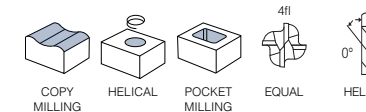
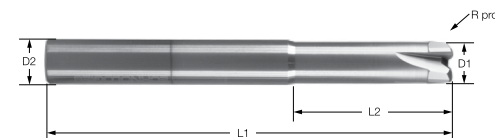

MAGIA HIGH FEED, 4 FLUTE

DESIGNATION	GRADE	D1	D2	L1	L2	CATALOG #
EHF Z4 D03.0(06) L02.0(070) R0.37	LT 4000	3	6	70	12	M5003600
EHF Z4 D04.0(06) L02.0(070) R0.47	LT 4000	4	6	70	16	M5003601
EHF Z4 D05.0(06) L02.5(070) R0.60	LT 4000	5	6	70	20	M5003602
EHF Z4 D06.0(06) L03.0(070) R0.73	LT 4000	6	6	70	25	M5003603
EHF Z4 D08.0(08) L04.0(080) R0.98	LT 4000	8	8	80	30	M5003604
EHF Z4 D10.0(10) L05.0(090) R1.23	LT 4000	10	10	90	35	M5003605
EHF Z4 D12.0(12) L06.0(100) R1.65	LT 4000	12	12	100	40	M5003606

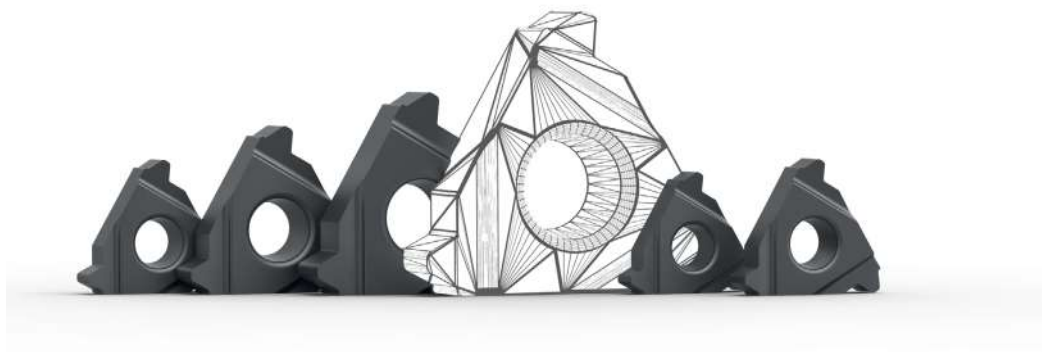

MADE IN SWITZERLAND



THREAD MILLING

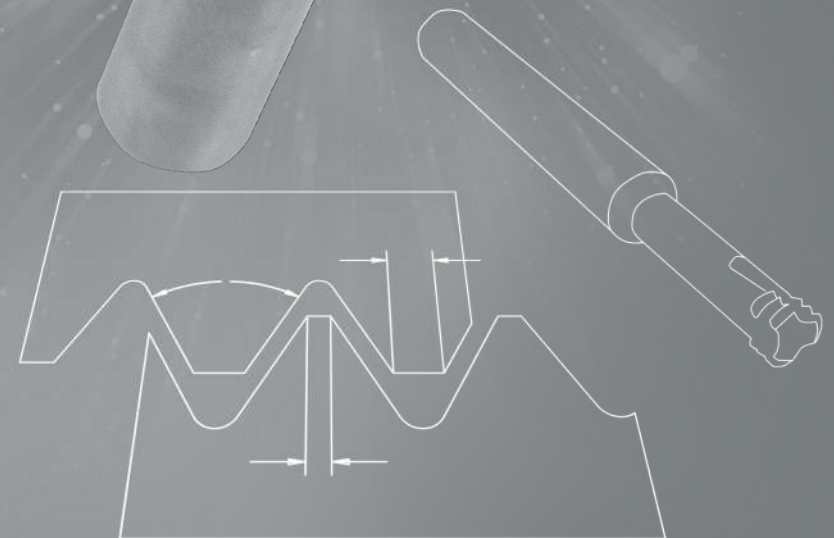
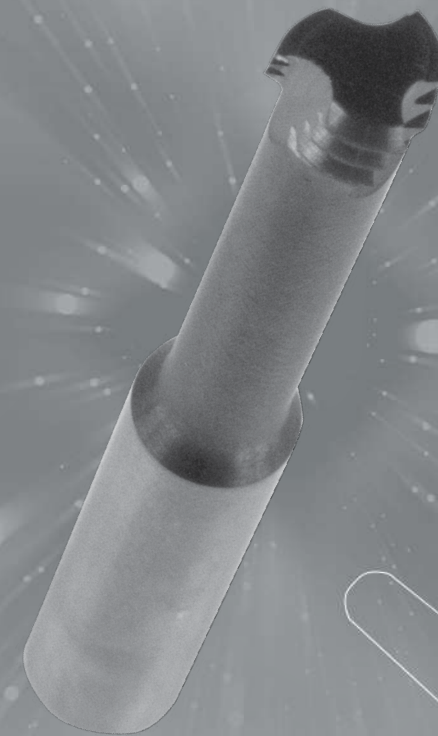

THREAD
MILLING

THREAD MILLING

Thread milling is the recommended method anytime producing threads involves variation of dimensions, difficult materials, weak set-ups, slim walls, tap breakage risks, expensive components, tiny tolerances, good surface finishing, long overhangs, right or left hand threads and eventual other obstacles.

ADVANTAGES OF THREAD MILLING

- Continuous spindle rotation – no need to stop and reverse the spindle when coming out of the hole
- Less spindle maintenance and no need of expensive synchronized tap holders
- Easy machining of difficult materials that produces short and controllable chips and much less cutting forces
- Full bottom threading with precise thread depth control and start position
- Less cutting pressure for thin-walled workpieces - less breakage and deformation risks
- One tool for a variety of thread diameters with the same thread pitch
- One tool for both right and left-hand threads as well as through or blind holes
- Minimized tool inventory, less tooling costs



ISO

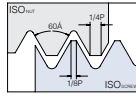

ISO 965-1:1999-11
DIN13 : 2005-08

UN

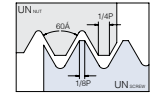

ANSI B1.1-1982



ISO METRIC - INTERNAL MINIATURE TOOL

DESIGNATION	THREAD SIZE	PITCH mm	L	L1	D1	D2	Z	CATALOG #
TMC03012L5 0.35 ISO	M1.6X0.35	0.35	39	5.1	3	1.20	3	TH400001
TMC06015L6 0.4 ISO	M2.0X0.40	0.40	39	6.1	6	1.54	3	TH400019
TMC06019L7 0.45 ISO	M2.5X0.45	0.45	39	7.6	6	1.96	3	TH400016
TMC06024L9 0.5 ISO	M3.0X0.50	0.50	51	9.3	6	2.40	3	TH400013
TMC06031L12 0.7 ISO	M4.0X0.70	0.70	51	12.4	6	3.15	3	TH400004
TMC06040L15 0.8 ISO	M5.0X0.80	0.80	57	15.6	6	4.00	3	TH400010
TMC06047L19 1.0 ISO	M6.0X1.00	1.00	57	19.0	6	4.75	3	TH400007
TMC06059L24 1.25 ISO	M8.0X1.25	1.25	57	24.3	6	5.95	3	TH400022
TMC08079L31 1.5 ISO	M10X1.50	1.50	63	31.0	8	7.90	3	TH400025

UN - INTERNAL MINIATURE TOOL

DESIGNATION	THREAD SIZE		TPI	L	L1	D1	D2	Z	CATALOG #
	UNC	UNF							
TMC03011L3 80 UN	-	0-80UNF	80	39	3.9	3	1.18	3	TH400052
TMC03014L5 72 UN	-	1-72UNF	72	39	5.8	3	1.44	3	TH400040
TMC03016L6 56 UN	2-56UNC	3-56UNF	56	39	6.8	3	1.66	3	TH400034
TMC06021L8 40 UN	4-40UNC	-	40	51	8.1	6	2.12	3	TH400028
TMC06024L9 40 UN	5-40UNC	6-40UNF	40	51	9.8	6	2.46	3	TH400055
TMC06025L10 32 UN	6-32UNC	-	32	51	10.7	6	2.57	3	TH400031
TMC06032L12 32 UN	8-32UNC	10-32UNF	32	57	12.7	6	3.22	3	TH400037
TMC06048L19 20 UN	1/4-20UNC	7/16-20UNF	20	57	19.4	6	4.85	3	TH400046
TMC06052L19 28 UN	-	1/4-28UNF	28	57	19.3	6	5.20	3	TH400043
TMC08066L24 24 UN	-	5/16-24UNF	24	63	24.2	8	6.65	3	TH400049

**We keep your machine
with the green light on**



DRILLING



INDEXABLE DRILLING

MULTI-MAT™ indexable drilling solutions for general drilling in a variety of

SPMG MULTI-MAT™ drilling inserts are designed with optimized grade and geometry for high performance in steel, stainless steel, cast iron and hardened metals. They are also suitable for super alloys and aluminum.

MULTI-MAT™ SPMG DRILLING INSERTS

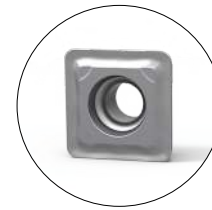

Same insert for both inner and outer pocket

MULTI-MAT™ grade and geometry provide more versatility and reduced stock of unused inserts.

4 cutting edges

FULL RANGE OF 2X, 3X, & 4X D DRILL BODIES

Diameter range
Ø12.5 - Ø41

Available
in drill depths of 2xD,
3xD, 4xD

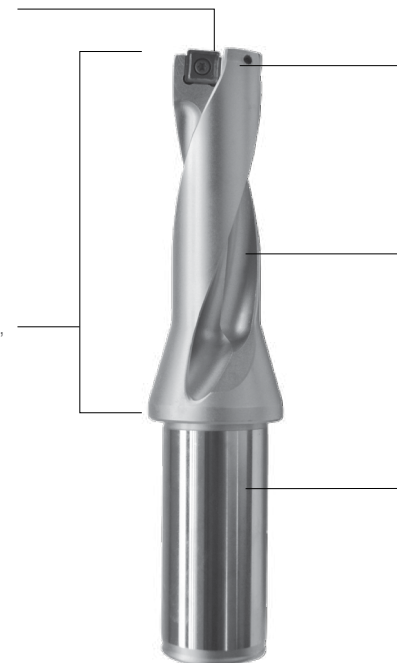

Hardened protection
against chip abrasion
extends tool life

Wide helical chip flute for
effective chip evacuation

Through coolant for
improved tool life
and smoother chip
evacuation



SPMG



2 X D DRILL BODIES - SPMG

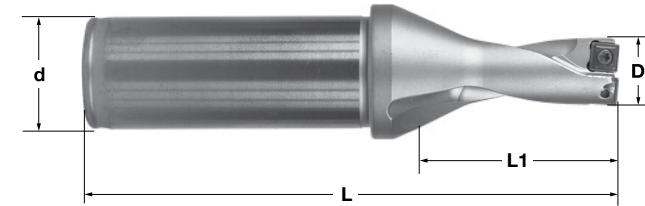

DESIGNATION	GRADE	MATERIAL RECOMMENDATION	L	S	R	CUTTING DATA	CATALOG #
SPMG 050204 NN	LT 30		5.0	2.38	0.40	p.346 - 349	M3003882
SPMG 060204 NN	LT 30		6.0	2.38	0.40	p.346 - 349	M3002913
SPMG 07T308 NN	LT 30		7.94	3.97	0.80	p.346 - 349	M3002914
SPMG 090408 NN	LT 30		9.80	4.30	0.80	p.346 - 349	M3002915
SPMG 110408 NN	LT 30		11.50	4.80	0.80	p. 346 - 349	M3003883

APPLICATION GUIDE			
RECOMMENDED		SUITABLE	
Interrupted Drilling	Cross Drilling	Irregular Surface Drilling	Interrupted Drilling

MATERIAL GUIDE	
RECOMMENDED	SUITABLE

2XD DRILL BODIES - SPMG 050204

DESIGNATION	D	d	L	L1	CATALOG #
LT DR125 S05-2D	12.5	20	94	26	M2003704
LT DR130 S05-2D	13.0	20	94	26	M2003705
LT DR135 S05-2D	13.5	20	96	28	M2003706
LT DR140 S05-2D	14.0	20	96	28	M2003707
LT DR145 S05-2D	14.5	20	99	30	M2003708
LT DR150 S05-2D	15.0	20	99	30	M2003709

2XD DRILL BODIES - SPMG 060204

DESIGNATION	D	d	L	L1	CATALOG #
LT DR160 S06-2D	16.0	25	108	32	M2003247
LT DR170 S06-2D	17.0	25	110	34	M2003248
LT DR175 S06-2D	17.5	25	113	36	M2003695
LT DR180 S06-2D	18.0	25	113	36	M2003249
LT DR185 S06-2D	18.5	25	115	38	M2003696
LT DR190 S06-2D	19.0	25	115	38	M2003250
LT DR200 S06-2D	20.0	25	119	40	M2003251
LT DR210 S06-2D	21.0	25	121	42	M2003252

MATERIAL GROUP	
STEEL	HIGH TEMP ALLOYS
STAINLESS STEEL	HARDENED MATERIAL
CAST IRON	ALU(>8%Si)



2 X D DRILL BODIES - SPMG

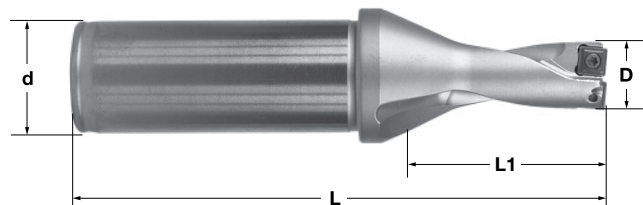

2XD DRILL BODIES - SPMG 07T308

DESIGNATION	D	d	L	L1	CATALOG #
LT DR220 S07-2D	22.0	25	123	44	M2003253
LT DR230 S07-2D	23.0	32	131	46	M2003255
LT DR240 S07-2D	24.0	32	134	48	M2003256
LT DR250 S07-2D	25.0	32	137	50	M2003257
LT DR260 S07-2D	26.0	32	139	52	M2003258
LT DR265 S07-2D	26.5	32	141	54	M2003698
LT DR270 S07-2D	27.0	32	141	54	M2003259

2XD DRILL BODIES - SPMG 090408

DESIGNATION	D	d	L	L1	CATALOG #
LT DR280 S09-2D	28.0	32	144	56	M2003260
LT DR290 S09-2D	29.0	32	146	58	M2003261
LT DR295 S09-2D	29.5	32	151	60	M2003699
LT DR300 S09-2D	30.0	32	151	60	M2003262
LT DR310 S09-2D	31.0	32	154	62	M2003263
LT DR320 S09-2D	32.0	32	156	64	M2003264
LT DR330 S09-2D	33.0	32	159	66	M2003265

2XD DRILL BODIES - SPMG 110408

DESIGNATION	D	d	L	L1	CATALOG #
LT DR340 S11-2D	34.0	40	171	68	M2003710
LT DR350 S11-2D	35.0	40	174	70	M2003711
LT DR360 S11-2D	36.0	40	177	72	M2003712
LT DR370 S11-2D	37.0	40	180	74	M2003713
LT DR380 S11-2D	38.0	40	183	76	M2003714
LT DR390 S11-2D	39.0	40	185	78	M2003715
LT DR400 S11-2D	40.0	40	188	80	M2003716
LT DR410 S11-2D	41.0	40	191	82	M2003717

3 X D DRILL BODIES - SPMG

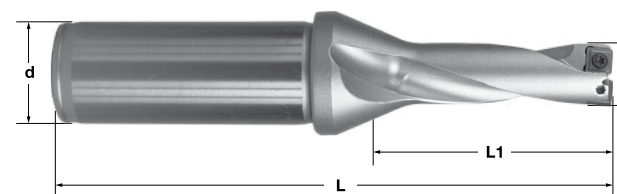

3XD DRILL BODIES - SPMG 050204

DESIGNATION	D	d	L	L1	CATALOG #
LT DR125 S05-3D	12.5	20	107	39	M2003718
LT DR130 S05-3D	13.0	20	107	39	M2003719
LT DR135 S05-3D	13.5	20	110	42	M2003720
LT DR140 S05-3D	14.0	20	110	42	M2003721
LT DR145 S05-3D	14.5	20	114	45	M2003722
LT DR150 S05-3D	15.0	20	114	45	M2003723

3XD DRILL BODIES - SPMG 060204

DESIGNATION	D	d	L	L1	CATALOG #
LT DR160 S06-3D	16.0	25	124	48	M2003266
LT DR170 S06-3D	17.0	25	127	51	M2003267
LT DR175 S06-3D	17.5	25	131	54	M2003700
LT DR180 S06-3D	18.0	25	131	54	M2003268
LT DR185 S06-3D	18.5	25	134	57	M2003701
LT DR190 S06-3D	19.0	25	134	57	M2003269
LT DR200 S06-3D	20.0	25	139	60	M2003270
LT DR210 S06-3D	21.0	25	142	63	M2003271

3 X D DRILL BODIES - SPMG

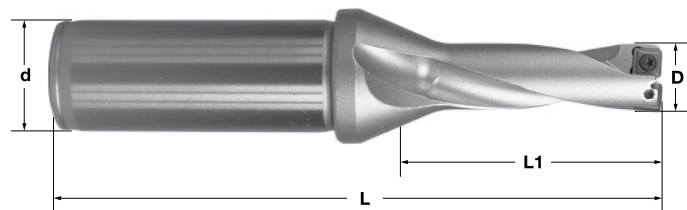

3XD DRILL BODIES - SPMG 07T308

DESIGNATION	D	d	L	L1	CATALOG #
LT DR220 S07-3D	22.0	25	145	66	M2003272
LT DR230 S07-3D	23.0	32	154	69	M2003273
LT DR240 S07-3D	24.0	32	158	72	M2003274
LT DR250 S07-3D	25.0	32	162	75	M2003275
LT DR260 S07-3D	26.0	32	165	78	M2003276
LT DR265 S07-3D	26.5	32	168	81	M2003702
LT DR270 S07-3D	27.0	32	168	81	M2003277

3XD DRILL BODIES - SPMG 090408

DESIGNATION	D	d	L	L1	CATALOG #
LT DR280 S09-3D	28.0	32	172	84	M2003278
LT DR290 S09-3D	29.0	32	175	87	M2003280
LT DR295 S09-3D	29.5	32	181	90	M2003703
LT DR300 S09-3D	30.0	32	181	90	M2003281
LT DR310 S09-3D	31.0	32	185	93	M2003282
LT DR320 S09-3D	32.0	32	188	96	M2003283
LT DR330 S09-3D	33.0	32	192	99	M2003284

3XD DRILL BODIES - SPMG 110408

DESIGNATION	D	d	L	L1	CATALOG #
LT DR340 S11-3D	34.0	40	205	102	M2003724
LT DR350 S11-3D	35.0	40	209	105	M2003725
LT DR360 S11-3D	36.0	40	213	108	M2003726
LT DR370 S11-3D	37.0	40	217	111	M2003727
LT DR380 S11-3D	38.0	40	221	114	M2003728
LT DR390 S11-3D	39.0	40	224	117	M2003729
LT DR400 S11-3D	40.0	40	228	120	M2003730
LT DR410 S11-3D	41.0	40	232	123	M2003731

4 X D DRILL BODIES - SPMG

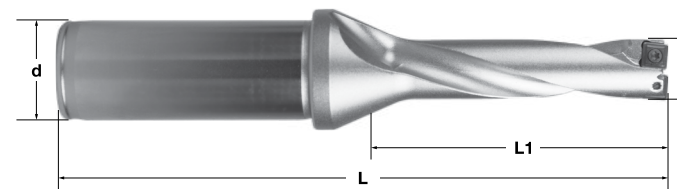

4XD DRILL BODIES* - SPMG 050204

DESIGNATION	D	d	L	L1	CATALOG #
LT DR125 S05-4D	12.5	20	120	52	M2003732
LT DR130 S05-4D	13.0	20	120	52	M2003733
LT DR135 S05-4D	13.5	20	124	56	M2003434
LT DR140 S05-4D	14.0	20	124	56	M2003735
LT DR145 S05-4D	14.5	20	129	60	M2003736
LT DR150 S05-4D	15.0	20	129	60	M2003737

* On Request

4XD DRILL BODIES* - SPMG 060204

DESIGNATION	D	d	L	L1	CATALOG #
LT DR155 S06-4D	15.5	25	140	64	M2003746
LT DR160 S06-4D	16.0	25	140	64	M2003747
LT DR165 S06-4D	16.5	25	144	68	M2003748
LT DR170 S06-4D	17.0	25	144	68	M2003749
LT DR175 S06-4D	17.5	25	149	72	M2003750
LT DR180 S06-4D	18.0	25	149	72	M2003751
LT DR185 S06-4D	18.5	25	153	76	M2003752
LT DR190 S06-4D	19.0	25	153	76	M2004380
LT DR195 S06-4D	19.5	25	159	80	M2003753
LT DR200 S06-4D	20.0	25	159	80	M2003754
LT DR205 S06-4D	20.5	25	163	84	M2003755
LT DR210 S06-4D	21.0	25	163	84	M2003756
LT DR215 S06-4D	21.5	25	167	88	M2003757

* On Request

4 X D DRILL BODIES - SPMG

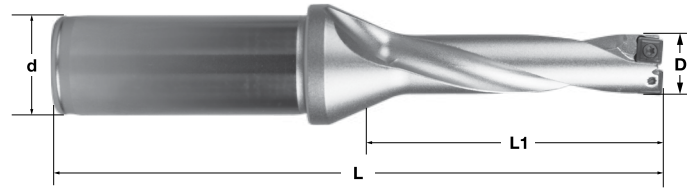

4XD DRILL BODIES* - SPMG 07T308

DESIGNATION	D	d	L	L1	CATALOG #
LT DR220 S07-4D	22.0	25	167	88	M2003758
LT DR225 S07-4D	22.5	32	177	92	M2003759
LT DR230 S07-4D	23.0	32	177	92	M2003760
LT DR235 S07-4D	23.5	32	182	96	M2003761
LT DR240 S07-4D	24.0	32	182	96	M2004381
LT DR245 S07-4D	24.5	32	187	100	M2003762
LT DR250 S07-4D	25.0	32	187	100	M2003763
LT DR255 S07-4D	25.5	32	191	104	M2003764
LT DR260 S07-4D	26.0	32	191	104	M2003765
LT DR265 S07-4D	26.5	32	195	108	M2003766
LT DR270 S07-4D	27.0	32	195	108	M2003767
LT DR275 S07-4D	27.5	32	200	112	M2003768

* On Request

4XD DRILL BODIES* - SPMG 090408

DESIGNATION	D	d	L	L1	CATALOG #
LT DR280 S09-4D	28.0	32	200	112	M2003769
LT DR285 S09-4D	28.5	32	204	116	M2003770
LT DR290 S09-4D	29.0	32	204	116	M2003771
LT DR295 S09-4D	29.5	32	211	120	M2003772
LT DR300 S09-4D	30.0	32	211	120	M2003773
LT DR310 S09-4D	31.0	32	216	124	M2003774
LT DR320 S09-4D	32.0	32	220	128	M2003775
LT DR330 S09-4D	33.0	32	225	132	M2003776

* On Request

4 X D DRILL BODIES - SPMG

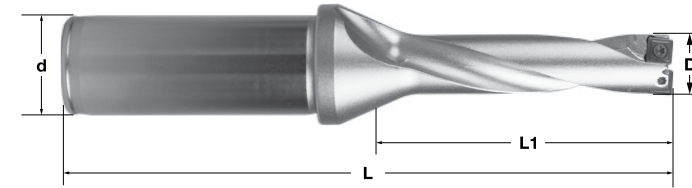

4XD DRILL BODIES* - SPMG 110408

DESIGNATION	D	d	L	L1	CATALOG #
LT DR340 S11-4D	34.0	40	239	136	M2003738
LT DR350 S11-4D	35.0	40	244	140	M2003739
LT DR360 S11-4D	36.0	40	249	144	M2003740
LT DR370 S11-4D	37.0	40	254	148	M2003741
LT DR380 S11-4D	38.0	40	259	152	M2003742
LT DR390 S11-4D	39.0	40	263	156	M2003743
LT DR400 S11-4D	40.0	40	268	160	M2003744
LT DR410 S11-4D	41.0	40	273	164	M2003745

* On Request

DRILL BODY SPARE PARTS

SPARE PARTS PER INSERT	KEY	SCREW
SPMG 050204 NN LT 30	M2004169	M2003820
SPMG 060204 NN LT 30	M2004169	M2003823
SPMG 07T308 NN LT 30	M2002912	M2003824
SPMG 090408 NN LT 30	M2000602	M2003821
SPMG 110408 NN LT 30	M2000602	M2003822

W C M X



ALPHA

DESIGNATION	GRADE	MATERIAL RECOMMENDATION	L	S	R	CUTTING DATA	CATALOG #
WCMX 040208 NN	LT 30		4.0	2.38	0.8	p.346 - 349	M3001122
WCMX 050308 NN	LT 30		5.0	3.18	0.8	p.346 - 349	M3001121
WCMX 06T308 NN	LT 30		6.0	3.97	0.8	p.346 - 349	M3000953
WCMX 080412 NN	LT 30		8.0	4.76	1.2	p.346 - 349	M3000954

TECHNICAL INFORMATION

MACHINING CONDITIONS	219
TURNING	219
LT 10 - LT 1000	219
LT 1110S	244
LT 1120M	247
LT 1125P	249
LT 05	251
PARTING AND GROOVING	253
MILLING	257
LT 30 - LT 3000	257
LT 3130	310
LT 05	324
SOLID END MILLS	325
THREADING - TURNING AND MILLING	339
DRILLING	345
TECHNICAL GUIDE	351
LAMINA MATERIAL GUIDE	377

MATERIAL GROUP	
STEEL	HIGH TEMP ALLOYS
STAINLESS STEEL	HARDENED MATERIAL
CAST IRON	ALU(>8%Si)



MACHINING CONDITIONS

TURNING

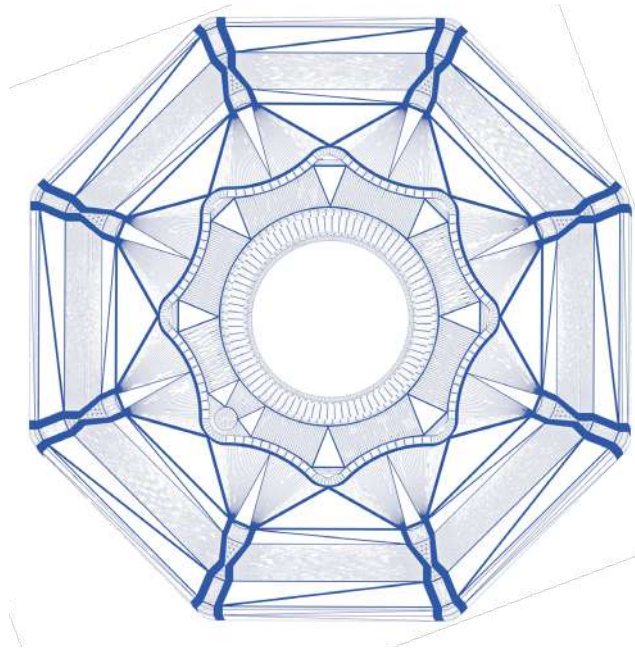

HIGH TECHNOLOGY



CCMT 09T304 NN
 CCMT 120404 NN
 CNMG 120404 NN
 CPMT 09T304 NN
 DCMT 11T304 NN
 DNMG 110404 NN
 DNMG 150404 NN
 DNMG 150604 NN

SCMT 09T304 NN
 TCMT 16T304 NN
 TNMG 160404 NN
 TNMG 220404 NN
 TNUX 160404 L
 TNUX 160404 R
 TPRM 160304 NN
 VBMT 160404 NN

VCMT 160404 NN
 VNMG 160404 NN
 WNMG 060404 NN
 WNMG 080404 NN
 WNMP 060404 NN

CCMT 09T308 NN
 CPMT 09T308 NN
 DCMT 11T308 NN
 SCMT 09T308 NN
 VBMT 160408 NN
 VCMT 160408 NN
 VNMG 160408 NN

Material Group	Lamina Gr. N°	Material Examples	Hardness	DOC [mm]		Feed [mm/rev]		Vc		Amax [mm²]	Suggested Starting Parameters						
				min	max	min	max	min	max		DOC	Feed	Vc				
P	Non Alloyed	1 C35, Ck45, 1020, 1045, 1060, 28Mn6	125 HB	0.30	3.0	0.11	0.23	180	330	0.60	2.00	0.18	300				
			190 HB										260				
			250 HB										240				
	Low Alloyed	2 42CrMo4, St50, Ck60, 4140, 4340, 100Cr6	180 HB 230 HB 280 HB 350 HB	0.30	2.50	0.10	0.20	120	280	0.50	2.00	0.14	0.13	260			
														250	0.48	240	
														210	0.40	200	
														180	0.36	180	
	High Alloyed	3 X40CrMoV5, H13, M42, D3, S6-5-2, 12Ni19	220 HB 280 HB 320 HB 350 HB	0.30	2.50	0.09	0.18	70	190	0.40	1.70	0.10	0.10	180			
														150	0.32	140	
														130	0.26	120	
														110	0.26	110	
	Austenitic	4 304, 316, X5CrNi18-9	180 HB 240 HB	0.30	2.50	0.08	0.18	170	270	0.32	2.00	0.09	0.08	260			
160														0.26	210		
M Duplex	5 X2CrNiN23-4, S31500	290 HB 310 HB	0.30	2.00	0.08	0.14	80	150	0.20	1.70	0.08	0.08	140				
													70	0.20	140		
Ferritic & Martensitic	6 410, X6Cr17, 17-4PH, 430	200 HB 42 HRc	0.30	2.50	0.08	0.18	170	250	0.32	1.70	0.09	0.09	240				
													120	0.26	180		
K Grey	7 GG20, GG40, EN-GJL-250, N030B	150 HB 200 HB 250 HB	0.30	3.00	0.08	0.20	170	250	0.64	2.00	0.18	0.18	240				
													160	0.60	220		
													150	0.60	200		
K Malleable & Nodular	8 GGG40, GGG70, 50005	150 HB 200 HB 250 HB	0.30	2.50	0.08	0.18	120	250	0.48	2.00	0.13	0.13	240				
													230	0.40	220		
													190	0.40	180		
S Fe, Ni & Co based	9 Incoloy 800 Inconel 700 Stellite 21	240 HB 250 HB 350 HB	0.30	2.00	0.09	0.15	25	50	0.26	1.30	0.10	0.10	40				
													23	0.26	35		
													45	0.26	35		
S Ti based	10 T40 TiAl6V4	- -	0.30	2.00	0.09	0.16	35	60	0.32	1.30	0.14	0.10	50				
													45	0.26	60		
H Steel	11 X100 CrMo13, 440C, G-X260NiCr42 Ni-Hard 2 G-X300CrMo15	45 HRc 50 HRc 55 HRc 400 HB 55 HRc	0.30	1.80	0.05	0.12	50	100	0.20	1.40	0.10	0.10	90				
													90	0.17	1.10	0.08	80
													80	0.13	0.90	0.06	70
													60	0.17	1.10	0.10	50
													30	0.13	0.90	0.06	40
NF Aluminium	12 AlSi12	130 HB	0.30	4.00	0.10	0.30	200	400	0.70	2.00	0.23	0.23	350				

Material Group	Lamina Gr. N°	Material Examples	Hardness	DOC [mm]		Feed [mm/rev]		Vc		Amax [mm²]	Suggested Starting Parameters						
				min	max	min	max	min	max		DOC	Feed	Vc				
P	Non Alloyed	1 C35, Ck45, 1020, 1045, 1060, 28Mn6	125 HB	0.50	4.00	0.21	0.50	180	330	1.62	2.70	0.32	240				
			190 HB										220				
			250 HB										200				
	Low Alloyed	2 42CrMo4, St50, Ck60, 4140, 4340, 100Cr6	180 HB 230 HB 280 HB 350 HB	0.50	4.00	0.21	0.45	120	280	1.08	2.70	0.29	0.27	200			
														250	1.08	180	
														210	1.08	150	
														180	0.90	130	
	High Alloyed	3 X40CrMoV5, H13, M42, D3, S6-5-2, 12Ni19	220 HB 280 HB 320 HB 350 HB	0.50	3.20	0.18	0.40	70	190	1.08	2.30	0.27	0.25	140			
														150	0.72	120	
														130	0.72	100	
														110	0.72	90	
	Austenitic	4 304, 316, X5CrNi18-9	180 HB 240 HB	0.50	4.00	0.20	0.40	170	270	1.08	2.70	0.23	0.20	190			
160														0.90	170		
M Duplex	5 X2CrNiN23-4, S31500	290 HB 310 HB	0.50	3.20	0.18	0.35	80	150	0.72	2.30	0.22	0.22	100				
													70	0.72	90		
Ferritic & Martensitic	6 410, X6Cr17, 17-4PH, 430	200 HB 42 HRc	0.50	4.00	0.18	0.40	170	250	0.63	2.30	0.18	0.18	190				
													120	0.63	130		
K Grey	7 GG20, GG40, EN-GJL-250, N030B	150 HB 200 HB 250 HB	0.50	4.00	0.15	0.60	170	250	1.80	2.70	0.32	0.32	200				
													160	1.62	180		
													150	1.62	160		
K Malleable & Nodular	8 GGG40, GGG70, 50005	150 HB 200 HB 250 HB	0.50	4.00	0.15	0.50	120	250	1.35	2.70	0.27	0.27	180				
													230	1.17	160		
													190	1.08	140		
S Fe, Ni & Co based	9 Incoloy 800 Inconel 700 Stellite 21	240 HB 250 HB 350 HB	0.50	2.40	0.20	0.35	25	45	0.63	1.80	0.25	0.25	32				
													45	0.63	30		
													23	0.63	28		
S Ti based	10 T40 TiAl6V4	- -	0.50	3.20	0.20	0.40	35	55	0.72	1.80	0.30	0.27	45				
													45	0.63	55		
H Steel	11 X100 CrMo13, 440C, G-X260NiCr42 Ni-Hard 2 G-X300CrMo15	45 HRc 50 HRc 55 HRc 400 HB 55 HRc	0.50	2.00	0.11	0.30	50	100	0.54	1.80	0.23	0.23	80				
													90	0.36	1.40	0.18	70
													80	0.27	0.90	0.16	60
													60	0.36	1.40	0.14	50
													30	0.27	0.90	0.14	40
NF Aluminium	12 AlSi12	130 HB	0.50	4.80	0.20	0.60	200	400	1.62	2.70	0.36	0.36	280				

CCMT 120412 NN
CNMP 120412 NN
TCMT 16T312 NN

Material Group	Lamina Gr. N°	Material Examples	Hardness	DOC [mm]		Feed [mm/rev]		Vc		Amax [mm ²]	Suggested Starting Parameters								
				min	max	min	max	min	max		DOC	Feed	Vc						
P Non Alloyed Low Alloyed High Alloyed	1	C35, Ck45, 1020, 1045, 1060, 28Mn6	125 HB	0.50	5.00	0.21	0.60	180	330	2.16	3.00	0.42	240						
			190 HB						280				220						
			250 HB						250				200						
	2	42CrMo4, St50, Ck60, 4140, 4340, 100Cr6	180 HB	0.50	5.00	0.21	0.54	120	280	1.44	3.00	0.38	200						
			230 HB						250				180						
			280 HB						210				150						
			350 HB						180				130						
	3	X40CrMoV5, H13, M42, D3, S6-5-2, 12Ni19	220 HB	0.50	4.00	0.18	0.48	70	190	1.44	2.50	0.36	140						
			280 HB						150				120						
320 HB			130						100										
350 HB			110						90										
Austenitic	4	304, 316, X5CrNi18-9	180 HB	0.50	5.00	0.20	0.48	170	1.44	3.00	0.30	190							
			240 HB					160				170							
M Duplex	5	X2CrNiN23-4, S31500	290 HB	0.50	4.00	0.18	0.42	80	150	0.96	2.50	0.29	100						
			310 HB					70					90						
Ferritic & Martensitic	6	410, X6Cr17, 17-4PH, 430	200 HB	0.50	5.00	0.18	0.48	170	250	0.84	2.50	0.24	190						
			42 HRc					120					130						
K Grey	7	GG20, GG40, EN-GJL-250, N030B	150 HB	0.50	5.00	0.15	0.72	170	250	2.40	3.00	0.42	200						
			200 HB					160					230						
			250 HB					150					210						
K Malleable & Nodular	8	GGG40, GGG70, 50005	150 HB	0.50	5.00	0.15	0.60	120	230	1.56	3.00	0.36	180						
			200 HB					190					144						
			250 HB					190					144						
S Fe, Ni & Co based	9	Incoloy 800 Inconel 700 Stellite 21	240 HB	0.50	3.00	0.20	0.42	25	45	0.84	2.00	0.34	32						
			250 HB					23					40						
			350 HB					23					40						
S Ti based	10	T40 TiAl6V4	-	0.50	4.00	0.20	0.48	35	55	0.96	2.00	0.40	45						
			-					3.00					0.42	45	65	0.84	0.36	55	
H Steel Chilled Cast Iron White Cast Iron	11	X100 CrMo13, 440C, G-X260NiCr42 Ni-Hard 2 G-X300CrMo15	45 HRc	0.50	2.50	0.11	0.36	50	100	0.72	2.00	0.30	80						
			50 HRc					2.00					0.30	90	0.48	1.50	0.24	70	
			55 HRc					1.50					0.24	40	80	0.36	1.00	0.22	60
			400 HB					2.00					0.30	60	0.48	1.50	0.22	50	
			55 HRc					1.50					0.24	30	50	0.36	1.00	0.18	40
NF Aluminium	12	AlSi12	130 HB	0.50	6.00	0.20	0.72	200	400	2.16	3.00	0.48	280						

CCMT 060204 NN
CPMT 060204 NN
DCMT 070204 NN

TCMT 110204 NN
VBMT 110304 NN

Material Group	Lamina Gr. N°	Material Examples	Hardness	DOC [mm]		Feed [mm/rev]		Vc		Amax [mm ²]	Suggested Starting Parameters								
				min	max	min	max	min	max		DOC	Feed	Vc						
P Non Alloyed Low Alloyed High Alloyed	1	C35, Ck45, 1020, 1045, 1060, 28Mn6	125 HB	0.3	2.1	0.08	0.20	180	330	0.32	1.0	0.14	300						
			190 HB						280				260						
			250 HB						250				240						
	2	42CrMo4, St50, Ck60, 4140, 4340, 100Cr6	180 HB	0.3	1.8	0.08	0.17	120	280	0.30	1.0	0.11	260						
			230 HB						250				240						
			280 HB						210				200						
			350 HB						180				180						
	3	X40CrMoV5, H13, M42, D3, S6-5-2, 12Ni19	220 HB	0.3	1.8	0.07	0.15	70	190	0.25	0.9	0.08	180						
			280 HB						150				140						
320 HB			130						120										
350 HB			110						110										
Austenitic	4	304, 316, X5CrNi18-9	180 HB	0.3	1.8	0.06	0.15	170	270	0.20	1.0	260							
			240 HB					160				220							
M Duplex	5	X2CrNiN23-4, S31500	290 HB	0.3	1.4	0.06	0.12	80	150	0.12	0.85	140							
			310 HB					70				140							
Ferritic & Martensitic	6	410, X6Cr17, 17-4PH, 430	200 HB	0.3	1.8	0.06	0.15	170	250	0.20	0.9	240							
			42 HRc					120				190							
K Grey	7	GG20, GG40, EN-GJL-250, N030B	150 HB	0.3	2.1	0.06	0.17	170	250	0.40	1.0	0.16	240						
			200 HB					160					230						
			250 HB					150					210						
K Malleable & Nodular	8	GGG40, GGG70, 50005	150 HB	0.3	1.8	0.06	0.15	120	230	1.56	1.0	0.14	240						
			200 HB					190					140						
			250 HB					190					140						
S Fe, Ni & Co based	9	Incoloy 800 Inconel 700 Stellite 21	240 HB	0.3	1.4	0.08	0.13	25	50	0.16	0.7	0.08	40						
			250 HB					23					45						
			350 HB					23					45						
S Ti based	10	T40 TiAl6V4	-	0.3	1.4	0.07	0.12	35	60	0.16	0.7	50							
			-					0.14				45	65	0.2	0.11	60			
H Steel Chilled Cast Iron White Cast Iron	11	X100 CrMo13, 440C, G-X260NiCr42 Ni-Hard 2 G-X300CrMo15	45 HRc	0.3	1.3	0.04	0.1	50	100	0.12	0.7	0.08	90						
			50 HRc					1.1					0.09	90	0.10	0.6	0.06	80	
			55 HRc					1.0					0.08	40	80	0.08	0.5	0.05	70
			400 HB					1.1					0.1	60	0.11	0.6	0.08	50	
			55 HRc					1.0					0.08	30	50	0.08	0.5	0.05	40
NF Aluminium	12	AlSi12	130 HB	0.3	2.8	0.08	0.26	200	400	0.44	1.0	0.18	350						

CNMG 120408 NX
 DNMG 150408 NX
 DNMG 150608 NX
 DNUX 150608 R11
 KNUX 160405 L / R

TNMG 160408 NX
 TNMG 220408 NX
 TNUX 160408 L
 TNUX 160408 R

CNMG 120408 NN
 DNMG 110408 NN
 DNMG 150408 NN

DNMG 150608 NN
 TNMG 160408 NN
 TNMG 220408 NN

Material Group	Lamina Gr. N°	Material Examples	Hardness	DOC [mm]		Feed [mm/rev]		Vc		Amax [mm ²]	Suggested Starting Parameters						
				min	max	min	max	min	max		DOC	Feed	Vc				
P	Non Alloyed	C35, Ck45, 1020, 1045, 1060, 28Mn6	125 HB	0.50	5.00	0.18	0.50	180	330	1.71	3.00	0.36	240				
			190 HB						280			0.33	220				
			250 HB						250			1.42	0.31	200			
	Low Alloyed	2	42CrMo4, St50, Ck60, 4140, 4340, 100Cr6	180 HB	0.50	4.00	0.18	0.45	120	280	1.14	3.00	0.30	200			
				230 HB						250			0.29	180			
				280 HB						210			0.29	150			
				350 HB						180			0.95	2.70	0.29	130	
	High Alloyed	3	X40CrMoV5, H13, M42, D3, S6-5-2, 12Ni19	220 HB	0.50	4.00	0.16	0.40	70	190	1.14	2.50	0.29	140			
				280 HB						150			0.27	120			
				320 HB						130			0.76	100			
				350 HB						110			0.27	90			
	M	Austenitic	4	304, 316, X5CrNi18-9	0.50	5.00	0.18	0.40	170	270	1.14	3.00	0.24	190			
160									220	0.95			0.21	170			
Duplex		5	X2CrNiN23-4, S31500	0.50	4.00	0.16	0.35	80	150	0.76	2.50	0.23	100				
								70	140				0.23	90			
Ferritic & Martensitic		6	410, X6Cr17, 17-4PH, 430	0.50	5.00	0.16	0.40	170	250	0.67	2.50	0.19	190				
					4.00			120	190				2.20	130			
K	Grey	7	GG20, GG40, EN-GJL-250, N030B	0.50	5.00	0.13	0.60	170	250	1.90	3.00	0.33	200				
							160	230	1.71				180				
							0.55	150	210				1.71	160			
	Malleable & Nodular	8	GGG40, GGG70, 50005	0.50	5.00	0.13	0.50	120	250	1.42	3.00	0.29	180				
								230	124				1.24	160			
								190	114				1.14	140			
S	Fe, Ni & Co based	9	Incoloy 800	0.50	3.00	0.18	0.35	25	45	0.67	2.00	0.27	32				
			Inconel 700					250 HB	45				0.67	2.00	0.27	30	
			Stellite 21					350 HB	23				40	0.27	28		
	Ti based	10	T40	0.50	3.50	0.18	0.40	35	55	0.76	2.00	0.31	45				
			TiAl6V4		3.00		0.35	45	65				0.67	2.00	0.29	55	
	H	Steel	11	X100 CrMo13, 440C,	0.50	1.50	0.10	0.30	50	100	0.57	2.00	0.24	80			
G-X260NiCr42				50 HRc				2.00	0.25	90				0.38	1.50	0.19	70
55 HRc				1.50				0.20	40	80				0.28	1.00	0.17	60
Chilled Cast Iron		Ni-Hard 2	400 HB	2.00	0.25	60	0.38	1.50	1.50	0.17	50	0.17	50				
													50	0.17	50		
White Cast Iron		G-X300CrMo15	55 HRc	1.50	0.20	30	50	0.28	1.00	0.14	40	0.14	40				
	40												0.14	40			
NF	Aluminium	12	AlSi12	130 HB	0.50	6.00	0.18	0.60	200	400	1.71	3.00	0.38	280			

Material Group	Lamina Gr. N°	Material Examples	Hardness	DOC [mm]		Feed [mm/rev]		Vc		Amax [mm ²]	Suggested Starting Parameters						
				min	max	min	max	min	max		DOC	Feed	Vc				
P	Non Alloyed	C35, Ck45, 1020, 1045, 1060, 28Mn6	125 HB	0.50	5.00	0.21	0.50	180	330	1.80	3.00	0.38	240				
			190 HB						280			0.35	220				
			250 HB						250			1.50	0.33	200			
	Low Alloyed	2	42CrMo4, St50, Ck60, 4140, 4340, 100Cr6	180 HB	0.50	4.00	0.21	0.45	120	280	1.20	3.00	0.32	200			
				230 HB						250			0.32	180			
				280 HB						210			0.30	150			
				350 HB						180			1.00	2.70	0.30	130	
	High Alloyed	3	X40CrMoV5, H13, M42, D3, S6-5-2, 12Ni19	220 HB	0.50	4.00	0.18	0.40	70	190	1.20	2.50	0.30	140			
				280 HB						150			0.28	120			
				320 HB						130			0.80	2.20	0.28	100	
				350 HB						110			0.28	90			
	M	Austenitic	4	304, 316, X5CrNi18-9	0.50	5.00	0.20	0.40	170	270	1.20	3.00	0.25	190			
160									220	1.00			0.22	170			
Duplex		5	X2CrNiN23-4, S31500	0.50	4.00	0.18	0.35	80	150	0.80	2.50	0.24	100				
								70	140				0.24	90			
Ferritic & Martensitic		6	410, X6Cr17, 17-4PH, 430	0.50	5.00	0.18	0.40	170	250	0.70	2.50	0.20	190				
					4.00			120	190				2.20	130			
K	Grey	7	GG20, GG40, EN-GJL-250, N030B	0.50	5.00	0.15	0.60	170	250	2.00	3.00	0.35	200				
							160	230	1.80				180				
							0.55	150	210				1.80	160			
	Malleable & Nodular	8	GGG40, GGG70, 50005	0.50	5.00	0.15	0.50	120	250	1.50	3.00	0.30	180				
								230	130				1.30	160			
								190	120				1.20	140			
S	Fe, Ni & Co based	9	Incoloy 800	0.50	3.00	0.20	0.35	25	45	0.70	2.00	0.28	32				
			Inconel 700					250 HB	45				0.70	2.00	0.28	30	
			Stellite 21					350 HB	23				40	0.28	28		
	Ti based	10	T40	0.50	3.50	0.20	0.40	35	55	0.80	2.00	0.33	45				
			TiAl6V4		3.00		0.35	45	65				0.70	2.00	0.30	55	
	H	Steel	11	X100 CrMo13, 440C,	0.50	1.50	0.11	0.30	50	100	0.60	2.00	0.25	80			
G-X260NiCr42				50 HRc				2.00	0.25	90				0.40	1.50	0.20	70
55 HRc				1.50				0.20	40	80				0.30	1.00	0.18	60
Chilled Cast Iron		Ni-Hard 2	400 HB	2.00	0.25	60	0.40	1.50	1.50	0.17	50	0.17	50				
													50	0.17	50		
White Cast Iron		G-X300CrMo15	55 HRc	1.50	0.20	30	50	0.30	1.00	0.15	40	0.15	40				
	40												0.15	40			
NF	Aluminium	12	AlSi12	130 HB	0.50	6.00	0.20	0.60	200	400	1.80	3.00	0.40	280			

CNMG 120412 NN
DNMG 150412 NN
DNMG 150612 NN

TNMG 160412 NN
TNMG 220412 NN

CNMG 120412 NX

Material Group	Lamina Gr. N°	Material Examples	Hardness	DOC [mm]		Feed [mm/rev]		Vc		Amax [mm ²]	Suggested Starting Parameters				
				min	max	min	max	min	max		DOC	Feed	Vc		
P Non Alloyed Low Alloyed High Alloyed	1	C35, Ck45, 1020, 1045, 1060, 28Mn6	125 HB	0.70	6.00	0.26	0.68	180	330	3.06	4.00	0.50	240		
			190 HB									0.46	220		
			250 HB									0.44	200		
	2	42CrMo4, S150, Ck60, 4140, 4340, 100Cr6	180 HB	0.70	6.00	0.26	0.61	120	280	2.04	4.00	0.42	200		
			230 HB										180		
			280 HB		4.20	0.22	0.54		180	1.70		3.60	150		
			350 HB										130		
	3	X40CrMoV5, H13, M42, D3, S6-5-2, 12Ni19	220 HB	0.70	4.80	0.22	0.54	70	190	2.04	3.40	0.40	140		
			280 HB										120		
320 HB			3.60		0.47	130	1.36		3.40	0.37		100			
350 HB												90			
Austenitic	4	304, 316, X5CrNi18-9	180 HB	0.70	6.00	0.25	0.54	170	270	2.04	4.00	0.33	190		
			240 HB					160	220	1.70		0.29	170		
M Duplex	5	X2CrNiN23-4, S31500	290 HB	0.70	4.80	0.22	0.47	80	150	1.36	3.40	0.32	100		
			310 HB					70	140	0.90					
Ferritic & Martensitic	6	410, X6Cr17, 17-4PH, 430	200 HB	0.70	6.00	0.22	0.54	170	250	1.19	3.40	0.26	190		
			42 HRc					120	190	2.90			130		
K Grey	7	GG20, GG40, EN-GJL-250, N030B	150 HB	0.70	6.00	0.19	0.81	170	250	3.40	4.00	0.46	200		
			200 HB					160	230	3.06			180		
			250 HB					150	210	0.74			160		
K Malleable & Nodular	8	GGG40, GGG70, 50005	150 HB	0.70	6.00	0.19	0.68	250	255		4.00	0.40	180		
			200 HB					230	2.21	160					
			250 HB					190	2.04	140					
S Fe, Ni & Co based	9	Incoloy 800	240 HB	0.70	3.60	0.25	0.47	25	45	1.19	2.70	0.37	32		
		Inconel 700	250 HB					45	1.10	2.70			0.37	30	
		Stellite 21	350 HB					23	40	0.28			28		
S Ti based	10	T40	-	0.70	4.20	0.25	0.54	35	55	1.36	2.70	0.44	45		
		TiAl6V4	-					45	65	1.19			0.40	55	
H Steel Chilled Cast Iron White Cast Iron	11	X100 CrMo13, 440C, G-X260NiCr42	45 HRc	0.70	3.00	0.14	0.41	50	100	1.02	2.70	0.33	80		
			50 HRc					90	0.68	2.00			0.26	70	
			55 HRc					40	80	0.51			1.30	0.24	60
			400 HB					60	0.68	2.00			0.24	50	
			55 HRc					30	50	0.51			1.30	0.20	40
NF Aluminium	12	AlSi12	130 HB	0.70	7.20	0.25	0.81	200	400	3.06	4.00	0.53	280		

Material Group	Lamina Gr. N°	Material Examples	Hardness	DOC [mm]		Feed [mm/rev]		Vc		Amax [mm ²]	Suggested Starting Parameters				
				min	max	min	max	min	max		DOC	Feed	Vc		
P Non Alloyed Low Alloyed High Alloyed	1	C35, Ck45, 1020, 1045, 1060, 28Mn6	125 HB	0.70	6.00	0.22	0.60	180	330	2.34	4.00	0.50	240		
			190 HB									0.46	220		
			250 HB									0.44	200		
	2	42CrMo4, S150, Ck60, 4140, 4340, 100Cr6	180 HB	0.70	6.00	0.22	0.54	120	280	1.95	4.00	0.42	200		
			230 HB										180		
			280 HB		4.20	0.19	0.48		180	1.60		3.60	150		
			350 HB										130		
	3	X40CrMoV5, H13, M42, D3, S6-5-2, 12Ni19	220 HB	0.70	4.80	0.19	0.48	70	190	1.55	3.40	0.40	140		
			280 HB										120		
320 HB			3.60		0.42	130	1.10		3.40	0.37		100			
350 HB												90			
Austenitic	4	304, 316, X5CrNi18-9	180 HB	0.70	6.00	0.21	0.48	170	270	1.50	4.00	0.33	190		
			240 HB					160	220	1.40		0.29	170		
M Duplex	5	X2CrNiN23-4, S31500	290 HB	0.70	4.80	0.19	0.42	80	150		3.40	0.32	100		
			310 HB					70	140	0.90					
Ferritic & Martensitic	6	410, X6Cr17, 17-4PH, 430	200 HB	0.70	6.00	0.19	0.42	170	250	1.00	3.40	0.26	190		
			42 HRc					120	190	2.90			130		
K Grey	7	GG20, GG40, EN-GJL-250, N030B	150 HB	0.70	6.00	0.16	0.70	170	250	3.20	4.00	0.46	200		
			200 HB					160	230	3.00			180		
			250 HB					150	210	0.65			160		
K Malleable & Nodular	8	GGG40, GGG70, 50005	150 HB	0.70	6.00	0.16	0.60	250	280		4.00	0.40	180		
			200 HB					230	2.60	160					
			250 HB					190	2.40	140					
S Fe, Ni & Co based	9	Incoloy 800	240 HB	0.70	3.60	0.20	0.42	25	45	1.10	2.70	0.37	32		
		Inconel 700	250 HB					45	1.10	2.70			0.37	30	
		Stellite 21	350 HB					23	40	0.28			28		
S Ti based	10	T40	-	0.70	4.20	0.20	0.44	35	55	1.15	2.70	0.44	45		
		TiAl6V4	-					45	65	1.00			0.40	55	
H Steel Chilled Cast Iron White Cast Iron	11	X100 CrMo13, 440C, G-X260NiCr42	45 HRc	0.70	3.00	0.12	0.36	50	100	0.80	2.50	0.29	80		
			50 HRc					90	0.55	2.00			0.23	70	
			55 HRc					40	80	0.42			1.50	0.21	60
			400 HB					60	0.55	2.00			0.21	50	
			55 HRc					30	50	0.41			1.40	0.18	40
NF Aluminium	12	AlSi12	130 HB	0.70	7.20	0.23	0.70	200	400	2.5	4.00	0.53	280		

CNMG 120408 NM

SNMG 120408 NX

Material Group	Lamina Gr. N°	Material Examples	Hardness	DOC [mm]		Feed [mm/rev]		Vc		Amax [mm ²]	Suggested Starting Parameters							
				min	max	min	max	min	max		DOC	Feed	Vc					
P	Non Alloyed	C35, Ck45, 1020, 1045, 1060, 28Mn6	125 HB	0.50	5.00	0.21	0.65	180	330	2.70	3.60	0.42	240					
			190 HB						280				220					
			250 HB						250				200					
	Low Alloyed	2	42CrMo4, S150, Ck60, 4140, 4340, 100Cr6	180 HB	0.50	5.00	0.21	0.59	120	280	1.80	3.60	0.38	200				
				230 HB						250				180				
				280 HB						210				150				
				350 HB						180				130				
	High Alloyed	3	X40CrMoV5, H13, M42, D3, S6-5-2, 12Ni19	220 HB	0.50	4.00	0.18	0.52	70	190	1.80	3.00	0.36	140				
				280 HB						150				120				
320 HB				130						100								
Austenitic	4	304, 316, X5CrNi18-9	180 HB	0.50	5.00	0.20	0.52	170	270	1.80	3.60	0.30	190					
			240 HB					160	220	1.50			170					
			Duplex					5	X2CrNiN23-4, S31500	290 HB			0.50	4.00	0.18	0.46	80	150
310 HB	70	140		90														
Ferritic & Martensitic	6	410, X6Cr17, 17-4PH, 430	200 HB	0.50	5.00	0.18	0.52	170	250	1.05	3.00	0.24	190					
			42 HRc					120	190	2.60			130					
K	Grey	GG20, GG40, EN-GJL-250, N030B	150 HB	0.50	5.00	0.15	0.78	170	250	3.00	3.60	0.42	200					
			200 HB					160	230	2.70			180					
			250 HB					150	210	2.70			160					
Malleable & Nodular	8	GGG40, GGG70, 50005	150 HB	0.50	5.00	0.15	0.65	120	250	2.25	3.60	0.36	180					
			200 HB					230	1.95	160								
			250 HB					190	1.80	140								
S	Fe, Ni & Co based	Incoloy 800	0.50	2.10	0.24	0.46	25	45	45	0.84	1.70	0.35	32					
		Inconel 700						250 HB					30					
		Stellite 21						350 HB					28					
Ti based	10	T40	0.50	2.50	0.24	0.52	35	55	0.96	1.70	0.41	45						
		TiAl6V4					-	2.10	0.46			45	65	0.84	55			
H	Steel	X100 CrMo13, 440C, G-X260NiCr42	45 HRc	0.50	1.80	0.13	0.39	50	100	0.72	1.70	0.31	80					
			50 HRc					1.40	0.33	90			0.48	1.30	0.25	70		
			55 HRc					1.10	0.26	40			80	0.36	0.90	0.23	60	
			Chilled Cast Iron					Ni-Hard 2	400 HB	1.40			0.33	60	0.48	1.30	0.23	50
									White Cast Iron	G-X300CrMo15			55 HRc	1.10	0.26	30	50	0.36
NF	Aluminium	AlSi12	130 HB	0.50	4.20	0.24	0.78	200	400	2.16	2.60	0.50	280					

Material Group	Lamina Gr. N°	Material Examples	Hardness	DOC [mm]		Feed [mm/rev]		Vc		Amax [mm ²]	Suggested Starting Parameters							
				min	max	min	max	min	max		DOC	Feed	Vc					
P	Non Alloyed	C35, Ck45, 1020, 1045, 1060, 28Mn6	125 HB	0.50	5.00	0.26	0.70	180	330	2.41	3.00	0.51	240					
			190 HB						280				220					
			250 HB						250				200					
	Low Alloyed	2	42CrMo4, S150, Ck60, 4140, 4340, 100Cr6	180 HB	0.50	5.00	0.26	0.63	120	280	1.61	3.00	0.43	200				
				230 HB						250				180				
				280 HB						210				150				
				350 HB						180				130				
	High Alloyed	3	X40CrMoV5, H13, M42, D3, S6-5-2, 12Ni19	220 HB	0.50	4.00	0.22	0.56	70	190	1.61	2.50	0.41	140				
				280 HB						150				120				
320 HB				130						100								
Austenitic	4	304, 316, X5CrNi18-9	180 HB	0.50	5.00	0.25	0.56	170	270	1.61	3.00	0.34	190					
			240 HB					160	220	1.34			170					
			Duplex					5	X2CrNiN23-4, S31500	290 HB			0.50	4.00	0.22	0.49	80	150
310 HB	70	140		90														
Ferritic & Martensitic	6	410, X6Cr17, 17-4PH, 430	200 HB	0.50	5.00	0.22	0.56	170	250	0.94	2.50	0.27	190					
			42 HRc					120	190	2.20			130					
K	Grey	GG20, GG40, EN-GJL-250, N030B	150 HB	0.50	5.00	0.18	0.84	170	250	2.68	3.00	0.47	200					
			200 HB					160	230	2.41			180					
			250 HB					150	210	2.41			160					
Malleable & Nodular	8	GGG40, GGG70, 50005	150 HB	0.50	5.00	0.18	0.70	120	250	2.01	3.00	0.41	180					
			200 HB					230	1.74	160								
			250 HB					190	1.61	140								
S	Fe, Ni & Co based	Incoloy 800	0.50	3.00	0.25	0.49	25	45	45	0.94	2.00	0.38	32					
		Inconel 700						250 HB					30					
		Stellite 21						350 HB					28					
Ti based	10	T40	0.50	3.50	0.25	0.56	35	55	1.07	2.00	0.45	45						
		TiAl6V4					-	3.00	0.49			45	65	0.94	55			
H	Steel	X100 CrMo13, 440C, G-X260NiCr42	45 HRc	0.50	2.50	0.14	0.42	50	100	0.80	2.00	0.34	80					
			50 HRc					2.00	0.35	90			0.54	1.50	0.27	70		
			55 HRc					1.50	0.28	40			80	0.40	1.00	0.24	60	
			Chilled Cast Iron					Ni-Hard 2	400 HB	2.00			0.35	60	0.54	1.50	0.24	50
									White Cast Iron	G-X300CrMo15			55 HRc	1.50	0.28	30	50	0.40
NF	Aluminium	AlSi12	130 HB	0.50	6.00	0.25	0.84	200	400	2.41	3.00	0.54	280					

SNMG 120408 NN

SNMG 120412 NN

Material Group	Lamina Gr. N°	Material Examples	Hardness	DOC [mm]		Feed [mm/rev]		Vc		Amax [mm ²]	Suggested Starting Parameters						
				min	max	min	max	min	max		DOC	Feed	Vc				
Non Alloyed	1	C35, Ck45, 1020, 1045, 1060, 28Mn6	125 HB	0.50	5.00	0.30	0.70	180	330	2.54	3.00	0.54	240				
			190 HB						280			0.50	220				
			250 HB						250			0.47	200				
Low Alloyed	2	42CrMo4, S150, Ck60, 4140, 4340, 100Cr6	180 HB	0.50	5.00	0.30	0.63	120	280	1.69	3.00	0.45	200				
			230 HB						250				180				
			280 HB		4.00	0.25	0.56	210	2.70			0.43	150				
			350 HB					180					130				
High Alloyed	3	X40CrMoV5, H13, M42, D3, S6-5-2, 12Ni19	220 HB	0.50	4.00	0.25	0.56	70	190	1.69	2.50	0.43	140				
			280 HB						150				120				
			320 HB		3.00	0.49	130	2.20	0.40			100					
			350 HB				110					90					
Austenitic	4	304, 316, X5CrNi18-9	180 HB	0.50	5.00	0.28	0.56	170	2.70	1.69	3.00	0.36	190				
			240 HB					160					220	1.41	170		
Duplex	5	X2CrNiN23-4, S31500	290 HB	0.50	4.00	0.25	0.49	80	150	1.13	2.50	0.34	100				
			310 HB					70					140	90			
Ferritic & Martensitic	6	410, X6Cr17, 17-4PH, 430	200 HB	0.50	5.00	0.25	0.56	170	250	0.99	2.50	0.28	190				
			42 HRc					120					190	2.20	130		
Grey	7	GG20, GG40, EN-GJL-250, N030B	150 HB	0.50	5.00	0.21	0.84	170	250	2.82	3.00	0.50	200				
			200 HB					160					230	2.54	180		
			250 HB					150					210	160			
Malleable & Nodular	8	GGG40, GGG70, 50005	150 HB	0.50	5.00	0.21	0.70	120	250	2.12	3.00	0.43	180				
			200 HB					230					1.83	160			
			250 HB					190					1.69	140			
Fe, Ni & Co based	9	Incoloy 800	240 HB	0.50	3.00	0.28	0.49	25	45	0.99	2.00	0.40	32				
		Inconel 700	250 HB					45					30				
		Stellite 21	350 HB					23					40	28			
Ti based	10	T40	-	0.50	3.50	0.28	0.56	35	55	1.13	2.00	0.47	45				
		TiAl6V4	-					45					65	0.99	0.43	55	
Steel	11	X100 CrMo13, 440C, G-X260NiCr42	45 HRc	0.50	2.50	0.16	0.42	50	100	0.85	2.00	0.36	80				
			50 HRc					90					0.56	1.50	0.28	70	
			55 HRc		1.50			2.00			0.35	40	80	0.42	1.00	0.26	60
			400 HB									60					0.56
Chilled Cast Iron	11	Ni-Hard 2	400 HB	2.00	2.00	0.35	0.35	60	0.56	1.50	1.00	0.21	40				
			55 HRc					30					50	0.42	1.00	0.21	40
White Cast Iron	11	G-X300CrMo15	55 HRc	1.50	1.50	0.28	0.28	30	50	0.42	1.00	0.21	40				
Aluminium	12	AlSi12	130 HB	0.50	6.00	0.28	0.84	200	400	2.54	3.00	0.57	280				

Material Group	Lamina Gr. N°	Material Examples	Hardness	DOC [mm]		Feed [mm/rev]		Vc		Amax [mm ²]	Suggested Starting Parameters						
				min	max	min	max	min	max		DOC	Feed	Vc				
Non Alloyed	1	C35, Ck45, 1020, 1045, 1060, 28Mn6	125 HB	0.70	6.00	0.37	0.95	180	330	2.54	3.00	0.54	240				
			190 HB						280			0.50	220				
			250 HB						250			0.47	200				
Low Alloyed	2	42CrMo4, S150, Ck60, 4140, 4340, 100Cr6	180 HB	0.70	6.00	0.37	0.86	120	280	1.69	3.00	0.45	200				
			230 HB						250				180				
			280 HB		4.80	0.32	0.76	210	2.70			0.43	150				
			350 HB					180					2.20	3.60	0.56	130	
High Alloyed	3	X40CrMoV5, H13, M42, D3, S6-5-2, 12Ni19	220 HB	0.70	4.80	0.32	0.76	70	190	1.69	2.50	0.43	140				
			280 HB						150				120				
			320 HB		3.60	0.67	130	2.20	0.40			100					
			350 HB				110					90					
Austenitic	4	304, 316, X5CrNi18-9	180 HB	0.70	6.00	0.35	0.76	170	2.70	1.69	3.00	0.36	190				
			240 HB					160					220	2.20	170		
Duplex	5	X2CrNiN23-4, S31500	290 HB	0.70	4.80	0.32	0.67	80	150	1.13	2.50	0.34	100				
			310 HB					70					140	90			
Ferritic & Martensitic	6	410, X6Cr17, 17-4PH, 430	200 HB	0.70	6.00	0.32	0.76	170	250	0.99	2.50	0.28	190				
			42 HRc					120					190	2.20	130		
Grey	7	GG20, GG40, EN-GJL-250, N030B	150 HB	0.70	6.00	0.26	1.14	170	250	2.82	3.00	0.50	200				
			200 HB					160					230	2.54	180		
			250 HB					150					210	3.96	4.00	0.65	160
Malleable & Nodular	8	GGG40, GGG70, 50005	150 HB	0.70	6.00	0.26	0.95	120	250	2.12	3.00	0.43	180				
			200 HB					230					1.83	160			
			250 HB					190					1.69	140			
Fe, Ni & Co based	9	Incoloy 800	240 HB	0.70	3.60	0.35	0.67	25	45	0.99	2.00	0.40	32				
		Inconel 700	250 HB					45					30				
		Stellite 21	350 HB					23					40	28			
Ti based	10	T40	-	0.70	4.20	0.35	0.76	35	55	1.13	2.00	0.47	45				
		TiAl6V4	-					45					65	0.99	0.43	55	
Steel	11	X100 CrMo13, 440C, G-X260NiCr42	45 HRc	0.70	3.00	0.19	0.57	50	100	0.85	2.00	0.36	80				
			50 HRc					90					0.56	1.50	0.28	70	
			55 HRc		1.80			2.40			0.38	40	80	0.42	1.00	0.26	60
			400 HB									60					0.56
Chilled Cast Iron	11	Ni-Hard 2	400 HB	2.40	2.40	0.38	0.38	60	0.56	1.50	1.00	0.21	40				
			55 HRc					30					50	0.42	1.00	0.21	40
White Cast Iron	11	G-X300CrMo15	55 HRc	1.80	1.80	0.38	0.38	30	50	0.42	1.00	0.21	40				
Aluminium	12	AlSi12	130 HB	0.70	7.20	0.35	1.14	200	400	2.54	3.00	0.57	280				

WNMG 060408 NX
WNMG 080408 NX

WNMG 060408 NN
WNMG 080408 NN
WNMP 060408 NN
WNMP 080408 NN

Material Group	Lamina Gr. N°	Material Examples	Hardness	DOC [mm]		Feed [mm/rev]		Vc		Amax [mm²]	Suggested Starting Parameters																							
				min	max	min	max	min	max		DOC	Feed	Vc																					
P Non Alloyed Low Alloyed High Alloyed	1	C35, Ck45, 1020, 1045, 1060, 28Mn6	125 HB	0.50	2.50	0.18	0.50	180	330	1.13	1.80	0.36	240																					
			190 HB											0.45	280	0.30	220																	
			250 HB												250			0.31	200															
	2	42CrMo4, St50, Ck60, 4140, 4340, 100Cr6	180 HB	0.50	2.00	0.18	0.45	120	280	0.76	1.80	0.30	200																					
			230 HB											0.16	0.40	250	0.29	180																
			280 HB																1.80	150														
			350 HB																		210	1.60	130											
	3	X40CrMoV5, H13, M42, D3, S6-5-2, 12Ni19	220 HB	0.50	2.00	0.16	0.40	70	190	0.76	1.50	0.29	140																					
			280 HB											1.50	0.35	150	0.27	120																
320 HB			110																100															
350 HB																				130	1.30	90												
4	304, 316, X5CrNi18-9	180 HB	0.50	2.50	0.18	0.40	170	270	0.76	1.80	0.24	190																						
		240 HB											160	220	0.63	0.21	170																	
5	X2CrNiN23-4, S31500	290 HB	0.50	2.00	0.16	0.35	80	150	0.50	1.50	0.23	100																						
		310 HB											70	140	0.50	1.50	0.23	90																
6	410, X6Cr17, 17-4PH, 430	200 HB	0.50	2.50	0.16	0.40	170	250	0.44	1.50	0.19	190																						
		42 HRc											120	190	0.44	1.30	0.19	130																
7	GG20, GG40, EN-GJL-250, N030B	150 HB	0.50	2.50	0.13	0.60	170	250	1.26	1.80	0.33	200																						
		200 HB											160	230	1.13	180																		
		250 HB															150	210	1.13	160														
8	GGG40, GGG70, 50005	150 HB	0.50	2.50	0.13	0.50	120	250	0.95	1.80	0.29	180																						
		200 HB											230	0.82	1.80	0.29	160																	
		250 HB																190	0.76	1.80	0.29	140												
9	Incoloy 800	240 HB	0.50	1.50	0.18	0.35	25	45	0.44	1.20	0.27	32																						
		250 HB											45	0.44	1.20	0.27	30																	
		350 HB																23	40	1.20	0.27	28												
10	TiAl6V4	-	0.50	1.80	0.18	0.40	35	55	0.50	1.20	0.31	45																						
		-											1.50	0.35	45	65	0.44	0.29	55															
H Steel Chilled Cast Iron White Cast Iron	11	X100 CrMo13, 440C, G-X260NiCr42	45 HRc	0.50	1.30	0.10	0.30	0.50	100	0.38	1.20	0.24								80														
			50 HRc										1.00	0.25	90	0.25	0.90	0.19	70															
			55 HRc																		40	0.20	80	0.19	0.60	0.17	60							
			400 HB																									60	0.25	60	0.25	0.90	0.17	50
			55 HRc																															
55 HRc	0.80	0.20	30	50	0.19	0.60	0.14	40																										
12									AISI12	130 HB	0.50	3.00	0.18	0.60	200	400	1.13	1.80	0.38	280														

Material Group	Lamina Gr. N°	Material Examples	Hardness	DOC [mm]		Feed [mm/rev]		Vc		Amax [mm²]	Suggested Starting Parameters																							
				min	max	min	max	min	max		DOC	Feed	Vc																					
P Non Alloyed Low Alloyed High Alloyed	1	C35, Ck45, 1020, 1045, 1060, 28Mn6	125 HB	0.50	2.50	0.21	0.50	180	330	1.17	1.80	0.38	240																					
			190 HB											0.45	280	0.35	220																	
			250 HB															0.31	200															
	2	42CrMo4, St50, Ck60, 4140, 4340, 100Cr6	180 HB	0.50	2.50	0.21	0.45	120	280	0.78	1.80	0.32	200																					
			230 HB											2.00	150																			
			280 HB													1.80	130																	
			350 HB															1.80	130															
	3	X40CrMoV5, H13, M42, D3, S6-5-2, 12Ni19	220 HB	0.50	2.00	0.18	0.40	70	190	0.78	1.50	0.30	140																					
			280 HB											1.50	0.35	150	0.27	120																
320 HB			110																100															
350 HB																				110	90													
4	304, 316, X5CrNi18-9	180 HB	0.50	2.50	0.20	0.40	170	270	0.78	1.80	0.25	190																						
		240 HB											160	220	0.65	0.22	170																	
5	X2CrNiN23-4, S31500	290 HB	0.50	2.00	0.18	0.35	80	150	0.52	1.50	0.24	100																						
		310 HB											70	140	0.52	1.50	0.24	90																
6	410, X6Cr17, 17-4PH, 430	200 HB	0.50	2.50	0.18	0.40	170	250	0.46	1.50	0.20	190																						
		42 HRc											120	190	0.46	1.30	0.20	130																
7	GG20, GG40, EN-GJL-250, N030B	150 HB	0.50	2.50	0.15	0.60	170	250	1.30	1.80	0.35	200																						
		200 HB											160	230	1.17	180																		
		250 HB															150	210	1.17	160														
8	GGG40, GGG70, 50005	150 HB	0.50	2.50	0.15	0.50	120	250	0.98	1.80	0.30	180																						
		200 HB											230	0.85	1.80	0.30	160																	
		250 HB																190	0.78	1.80	0.30	140												
9	Incoloy 800	240 HB	0.50	1.50	0.20	0.35	25	45	0.46	1.20	0.28	32																						
		250 HB											45	0.46	1.20	0.28	30																	
		350 HB																23	40	1.20	0.28	28												
10	TiAl6V4	-	0.50	1.80	0.20	0.40	35	55	0.52	1.20	0.33	45																						
		-											1.50	0.35	45	65	0.46	0.30	55															
H Steel Chilled Cast Iron White Cast Iron	11	X100 CrMo13, 440C, G-X260NiCr42	45 HRc	0.50	1.30	0.11	0.30	50	100	0.39	1.20	0.25								80														
			50 HRc										1.00	0.25	90	0.26	0.90	0.20	70															
			55 HRc																		40	0.20	80	0.20	0.60	0.18	60							
			400 HB																									60	0.25	60	0.25	0.90	0.18	50
			55 HRc																															
55 HRc	0.80	0.20	30	50	0.20	0.60	0.15	40																										
12									AISI12	130 HB	0.50	3.00	0.20	0.60	200	400	1.17	1.80	0.40	280														

WNMG 080412 NN

Material Group	Lamina Gr. N°	Material Examples	Hardness	DOC [mm]		Feed [mm/rev]		Vc		Amax [mm ²]	Suggested Starting Parameters						
				min	max	min	max	min	max		DOC	Feed	Vc				
P	Non Alloyed	C35, Ck45, 1020, 1045, 1060, 28Mn6	125 HB	0.70	3.50	0.25	0.65	180	330	2.16	2.60	0.48	240				
			190 HB						280			0.44	220				
			250 HB						250			0.41	200				
	Low Alloyed	2	42CrMo4, S150, Ck60, 4140, 4340, 100Cr6	180 HB	0.70	3.50	0.25	0.59	120	280	1.44	2.60	0.40	200			
				230 HB						250			0.38	180			
				280 HB						210			0.38	150			
				350 HB						180			1.20	2.30	0.38	130	
	High Alloyed	3	X40CrMoV5, H13, M42, D3, S6-5-2, 12Ni19	220 HB	0.70	2.80	0.22	0.52	70	190	1.44	2.10	0.38	140			
				280 HB						150			0.35	120			
				320 HB						130			0.96	1.90	0.35	100	
				350 HB						110			0.96	1.90	0.35	90	
	M	Austenitic	4	304, 316, X5CrNi18-9	180 HB	0.70	3.50	0.24	0.52	170	270	1.44	2.60	0.31	190		
240 HB					160					220	1.20	0.28		170			
Duplex		5	X2CrNiN23-4, S31500	290 HB	0.70	2.80	0.22	0.46	80	150	0.96	2.10	0.30	100			
				310 HB					70	140	0.96	2.10	0.30	90			
Ferritic & Martensitic		6	410, X6Cr17, 17-4PH, 430	200 HB	0.70	3.50	0.22	0.52	170	250	0.84	2.10	0.25	190			
				42 HRc					120	190	1.90	0.25		130			
K	Grey	7	GG20, GG40, EN-GJL-250, N030B	150 HB	0.70	3.50	0.18	0.78	170	250	2.40	2.60	0.44	200			
				200 HB					160	230	2.16			0.44	180		
	Malleable & Nodular	8	GGG40, GGG70, 50005	150 HB	0.70	3.50	0.18	0.65	250	1.80	2.60	0.38	0.38	180			
				200 HB					230	1.56				0.38	160		
250 HB	190	1.44	0.38	140													
S	Fe, Ni & Co based	9	Incoloy 800	0.70	2.10	0.24	0.46	25	45	0.84	1.70	0.35	32				
			Inconel 700					250 HB	25	45	0.84		1.70	0.35	30		
			Stellite 21					350 HB	23	40	0.84		1.70	0.35	28		
Ti based	10	T40	0.70	2.50	0.24	0.52	35	55	0.96	1.70	0.41	45					
		TiAl6V4					2.10	0.46	45	65		0.84	1.70	0.38	55		
H	Steel	11	X100 CrMo13, 440C, G-X260NiCr42	45 HRc	0.70	1.80	0.13	0.39	50	100	0.72	1.70	0.31	80			
				50 HRc					1.40	0.33	90	0.48		1.30	0.25	70	
				55 HRc					1.10	0.26	40	80		0.36	0.90	0.23	60
				400 HB					1.40	0.33	60	0.48		1.30	0.23	50	
				55 HRc					1.10	0.26	30	50		0.36	0.90	0.19	40
White Cast Iron	12	AlSi12	130 HB	0.70	4.20	0.24	0.78	200	400	2.16	2.60	0.50	280				

WNMG 080408 NM

Material Group	Lamina Gr. N°	Material Examples	Hardness	DOC [mm]		Feed [mm/rev]		Vc		Amax [mm ²]	Suggested Starting Parameters						
				min	max	min	max	min	max		DOC	Feed	Vc				
P	Non Alloyed	C35, Ck45, 1020, 1045, 1060, 28Mn6	125 HB	0.50	3.50	0.25	0.65	180	330	2.16	2.60	0.48	240				
			190 HB						280			0.44	220				
			250 HB						250			0.41	200				
	Low Alloyed	2	42CrMo4, S150, Ck60, 4140, 4340, 100Cr6	180 HB	0.50	3.50	0.25	0.59	120	280	1.44	2.60	0.40	200			
				230 HB						250			0.38	180			
				280 HB						210			0.38	150			
				350 HB						180			1.20	2.30	0.38	130	
	High Alloyed	3	X40CrMoV5, H13, M42, D3, S6-5-2, 12Ni19	220 HB	0.50	2.80	0.22	0.52	70	190	1.44	2.10	0.38	140			
				280 HB						150			0.35	120			
				320 HB						130			0.96	1.90	0.35	100	
				350 HB						110			0.96	1.90	0.35	90	
	Austenitic	4	304, 316, X5CrNi18-9	180 HB	0.50	3.50	0.24	0.52	170	270	1.44	2.60	0.31	190			
240 HB				160					220	1.20	0.28		170				
Duplex	5	X2CrNiN23-4, S31500	290 HB	0.50	2.80	0.22	0.46	80	150	0.96	2.10	0.30	100				
			310 HB					70	140	0.96	2.10		0.30	90			
Ferritic & Martensitic	6	410, X6Cr17, 17-4PH, 430	200 HB	0.50	3.50	0.22	0.52	170	250	0.84	2.10	0.25	190				
			42 HRc					120	190	1.90	0.25		130				
K	Grey	7	GG20, GG40, EN-GJL-250, N030B	150 HB	0.50	3.50	0.18	0.78	170	250	2.40	2.60	0.44	200			
				200 HB					160	230	2.16			0.44	180		
	Malleable & Nodular	8	GGG40, GGG70, 50005	150 HB	0.50	3.50	0.18	0.65	250	1.80	2.60	0.38	0.38	180			
				200 HB					230	1.56				0.38	160		
250 HB	190	1.44	0.38	140													
S	Fe, Ni & Co based	9	Incoloy 800	0.50	2.10	0.24	0.46	25	45	0.84	1.70	0.35	32				
			Inconel 700					250 HB	25	45	0.84		1.70	0.35	30		
			Stellite 21					350 HB	23	40	0.84		1.70	0.35	28		
Ti based	10	T40	0.50	2.50	0.24	0.52	35	55	0.96	1.70	0.41	45					
		TiAl6V4					2.10	0.46	45	65		0.84	1.70	0.38	55		
H	Steel	11	X100 CrMo13, 440C, G-X260NiCr42	45 HRc	0.50	1.80	0.13	0.39	50	100	0.72	1.70	0.31	80			
				50 HRc					1.40	0.33	90	0.48		1.30	0.25	70	
				55 HRc					1.10	0.26	40	80		0.36	0.90	0.23	60
				400 HB					1.40	0.33	60	0.48		1.30	0.23	50	
				55 HRc					1.10	0.26	30	50		0.36	0.90	0.19	40
White Cast Iron	12	AlSi12	130 HB	0.50	4.20	0.24	0.78	200	400	2.16	2.60	0.50	280				

CNMM 120408 NR

CNMM 120412 NR

Material Group	Lamina Gr. N°	Material Examples	Hardness	DOC [mm]		Feed [mm/rev]		Vc		Amax [mm ²]	Suggested Starting Parameters				
				min	max	min	max	min	max		DOC	Feed	Vc		
P	Non Alloyed	C35, Ck45, 1020, 1045, 1060, 28Mn6	125 HB	0.50	7.00	0.21	0.60	180	330	2.88	4.20	0.46	240		
			190 HB						280			0.42	220		
			250 HB						250			0.40	200		
	Low Alloyed	2	42CrMo4, S150, Ck60, 4140, 4340, 100Cr6	180 HB	0.50	5.60	0.21	0.54	120	280	1.92	4.20	0.38	200	
				230 HB						250			0.36	180	
				280 HB						210				150	
				350 HB						180				1.60	3.80
	High Alloyed	3	X40CrMoV5, H13, M42, D3, S6-5-2, 12Ni19	220 HB	0.50	5.60	0.18	0.48	70	190	1.92	3.50	0.36	140	
				280 HB						150				120	
320 HB				130						1.28				3.10	100
350 HB				110						1.28				3.10	0.34
M	Austenitic	4	304, 316, X5CrNi18-9	180 HB	0.50	7.00	0.20	0.48	170	270	1.92	4.20	0.30	190	
				240 HB					160	220	1.60		0.26	170	
	Duplex	5	X2CrNiN23-4, S31500	290 HB	0.50	5.60	0.18	0.42	80	150	1.28	3.50	0.29	100	
				310 HB					70	140	3.10	90			
	Ferritic & Martensitic	6	410, X6Cr17, 17-4PH, 430	200 HB	0.50	7.00	0.18	0.48	170	250	1.12	3.50	0.24	190	
				42 HRc					120	190	3.10	130			
K	Grey	7	GG20, GG40, EN-GJL-250, N030B	150 HB	0.50	7.00	0.15	0.72	170	250	3.20	4.20	0.42	200	
				200 HB					160	230	2.88			180	
				250 HB					150	210	2.88			160	
Malleable & Nodular	8	GGG40, GGG70, 50005	150 HB	0.50	7.00	0.15	0.60	120	250	2.40	4.20	0.36	180		
			200 HB						230	2.08			160		
			250 HB						190	1.92			140		
S	Fe, Ni & Co based	9	Incoloy 800	0.50	4.20	0.20	0.42	25	45	1.12	2.80	0.34	32		
			Inconel 700					45	1.12				2.80	0.34	30
			Stellite 21					23	40				2.80	0.34	28
Ti based	10	TiAl6V4	-	0.50	4.90	0.20	0.48	35	55	1.28	2.80	0.40	45		
			-					4.20	0.20	0.42	45		65	1.12	2.80
H	Steel	11	X100 CrMo13, 440C, G-X260NiCr42	45 HRc	0.50	2.10	0.11	0.36	50	100	0.96	2.80	0.30	80	
				50 HRc				0.30	90	0.64	2.10	0.24		70	
				55 HRc				0.24	40	80	0.48	1.40		0.22	60
				400 HB				0.30	60	0.64	2.10	50			
				400 HB				0.30	60	0.64	2.10	50			
White Cast Iron	11	G-X300CrMo15	55 HRc	0.50	2.10	0.24	30	50	0.48	1.40	0.18	0.18	40		
			55 HRc				30	50	0.48	1.40	0.18	0.18	40		
NF	Aluminium	12	AlSi12	130 HB	0.50	8.40	0.20	0.72	200	400	2.88	4.20	0.48	280	

Material Group	Lamina Gr. N°	Material Examples	Hardness	DOC [mm]		Feed [mm/rev]		Vc		Amax [mm ²]	Suggested Starting Parameters						
				min	max	min	max	min	max		DOC	Feed	Vc				
P	Non Alloyed	1	C35, Ck45, 1020, 1045, 1060, 28Mn6	125 HB	0.70	7.00	0.21	0.60	180	330	3.24	5.00	0.46	240			
				190 HB						280			0.42	220			
				250 HB						250			0.40	200			
	Low Alloyed	2	42CrMo4, S150, Ck60, 4140, 4340, 100Cr6	180 HB	0.70	5.60	0.21	0.54	120	280	1.92	4.20	5.00	0.38	200		
				230 HB						250				0.36	180		
				280 HB						210					150		
				350 HB						180					1.80	4.50	0.36
	High Alloyed	3	X40CrMoV5, H13, M42, D3, S6-5-2, 12Ni19	220 HB	0.70	5.60	0.18	0.48	70	190	1.92	3.50	4.10	0.36	140		
				280 HB						150					120		
320 HB				130						1.44					3.60	0.34	100
350 HB				110						1.44					3.60	0.34	90
Austenitic	4	304, 316, X5CrNi18-9	180 HB	0.70	7.00	0.20	0.48	170	270	1.92	4.20	5.00	0.30	190			
			240 HB					160	220	1.60			0.26	170			
Duplex	5	X2CrNiN23-4, S31500	290 HB	0.70	5.60	0.18	0.42	80	150	1.28	3.50	0.29	100				
			310 HB					70	140	3.10	90						
Ferritic & Martensitic	6	410, X6Cr17, 17-4PH, 430	200 HB	0.70	7.00	0.18	0.48	170	250	1.12	3.50	0.24	190				
			42 HRc					120	190	3.10	130						
K	Grey	7	GG20, GG40, EN-GJL-250, N030B	150 HB	0.70	7.00	0.15	0.72	170	250	3.60	4.20	0.42	200			
				200 HB					160	230	3.24			180			
				250 HB					150	210	3.24			160			
Malleable & Nodular	8	GGG40, GGG70, 50005	150 HB	0.70	7.00	0.15	0.60	120	250	2.70	4.20	5.00	0.36	180			
			200 HB						230	2.34				160			
			250 HB						190	2.16				140			
S	Fe, Ni & Co based	9	Incoloy 800	0.70	4.20	0.20	0.42	25	45	1.12	2.80	0.34	32				
			Inconel 700					45	1.12				2.80	0.34	30		
			Stellite 21					23	40				2.80	0.34	28		
Ti based	10	TiAl6V4	-	0.70	4.90	0.20	0.48	35	55	1.28	2.80	0.40	45				
			-					4.20	0.20	0.42	45		65	1.12	2.80	0.36	55
H	Steel	11	X100 CrMo13, 440C, G-X260NiCr42	45 HRc	0.70	2.10	0.11	0.36	50	100	0.96	2.80	0.30	80			
				50 HRc				0.30	90	0.64	2.10	0.24		70			
				55 HRc				0.24	40	80	0.48	1.40		0.22	60		
				400 HB				0.30	60	0.64	2.10	50					
				400 HB				0.30	60	0.64	2.10	50					
White Cast Iron	11	G-X300CrMo15	55 HRc	0.70	2.10	0.24	30	50	0.48	1.40	0.18	0.18	40				
			55 HRc				30	50	0.48	1.40	0.18	0.18	40				
NF	Aluminium	12	AlSi12	130 HB	0.70	8.40	0.20	0.72	200	400	2.88	4.20	0.48	280			

CCMT 120408 NN
CNMP 120408 NN
TCMT 16T308 NN

TNMP 160408 NN
TPMR 160308 NN

RCMT 0602 M0

Material Group	Lamina Gr. N°	Material Examples	Hardness	DOC [mm]		Feed [mm/rev]		Vc		Amax [mm ²]	Suggested Starting Parameters								
				min	max	min	max	min	max		DOC	Feed	Vc						
P Non Alloyed Low Alloyed High Alloyed	1	C35, Ck45, 1020, 1045, 1060, 28Mn6	125 HB	0.50	5.00	0.21	0.50	180	330	1.80	3.00	0.35	240						
			190 HB						280				220						
			250 HB						250				200						
	2	42CrMo4, St50, Ck60, 4140, 4340, 100Cr6	180 HB	0.50	5.00	0.21	0.45	120	280	1.20	3.00	0.32	200						
			230 HB						250				180						
			280 HB		210	150													
			350 HB		180	130													
	3	X40CrMoV5, H13, M42, D3, S6-5-2, 12Ni19	220 HB	0.50	4.00	0.18	0.40	70	190	1.20	2.50	0.30	140						
			280 HB						150				120						
320 HB			130		100														
350 HB			110		90														
Austenitic	4	304, 316, X5CrNi18-9	180 HB	0.50	5.00	0.20	0.40	170	270	1.20	3.00	0.35	190						
			240 HB					160					220	170					
M Duplex	5	X2CrNiN23-4, S31500	290 HB	0.50	4.00	0.18	0.35	80	150	0.80	2.50	0.28	100						
			310 HB					70					140	90					
Ferritic & Martensitic	6	410, X6Cr17, 17-4PH, 430	200 HB	0.50	5.00	0.22	0.40	170	250	1.00	3.00	0.32	190						
			42 HRc					120					190	130					
K Grey	7	GG20, GG40, EN-GJL-250, N030B	150 HB	0.50	5.00	0.15	0.60	170	250	2.00	3.00	0.35	200						
			200 HB					160					230	180					
			250 HB					150					210	160					
K Malleable & Nodular	8	GGG40, GGG70, 50005	150 HB	0.50	5.00	0.15	0.50	250	1.50	3.00	0.30	0.30	180						
			200 HB					230					1.30	160					
			250 HB					190					1.20	140					
S Fe, Ni & Co based	9	Incoloy 800	240 HB	0.50	3.00	0.20	0.35	25	45	0.70	2.00	0.28	32						
		Inconel 700	250 HB					45					30						
		Stellite 21	350 HB					23					40	28					
S Ti based	10	T40	-	0.50	4.00	0.20	0.40	35	55	0.80	2.00	0.33	45						
		TiAl6V4	-					3.00					0.35	45	65	0.70	0.30	55	
H Steel Chilled Cast Iron White Cast Iron	11	X100 CrMo13, 440C, G-X260NiCr42	45 HRc	0.50	2.50	0.11	0.30	50	100	0.60	2.00	0.25	80						
			50 HRc					2.00					0.25	90	0.40	1.50	0.20	70	
			55 HRc					1.50					0.20	40	80	0.30	1.00	0.18	60
			400 HB					2.00					0.25	60	0.40	1.50	0.18	50	
NF Aluminium	12	AlSi12	130 HB	0.50	6.00	0.20	0.60	200	400	1.80	3.00	0.40	280						

Material Group	Lamina Gr. N°	Material Examples	Hardness	DOC [mm]		Feed [mm/rev]		Vc		Amax [mm ²]	Suggested Starting Parameters							
				min	max	min	max	min	max		DOC	Feed	Vc					
P Non Alloyed Low Alloyed High Alloyed	1	C35, Ck45, 1020, 1045, 1060, 28Mn6	125 HB	0.50	2.00	0.15	0.40	180	330	0.64	1.00	0.35	240					
			190 HB						280				220					
			250 HB						250				200					
	2	42CrMo4, St50, Ck60, 4140, 4340, 100Cr6	180 HB	0.50	2.00	0.15	0.35	120	280	0.56	1.00	0.30	200					
			230 HB						250				180					
			280 HB		210	150												
			350 HB		180	130												
	3	X40CrMoV5, H13, M42, D3, S6-5-2, 12Ni19	220 HB	0.50	2.00	0.13	0.30	70	190	0.48	1.00	0.30	140					
			280 HB						150				120					
320 HB			130		100													
350 HB			110		90													
Austenitic	4	304, 316, X5CrNi18-9	180 HB	0.50	2.00	0.14	0.35	170	270	0.32	1.00	0.30	190					
			240 HB					160					220	170				
M Duplex	5	X2CrNiN23-4, S31500	290 HB	0.50	1.50	0.13	0.30	80	150	0.30	1.00	0.28	100					
			310 HB					70					140	90				
Ferritic & Martensitic	6	410, X6Cr17, 17-4PH, 430	200 HB	0.50	2.00	0.15	0.35	170	250	0.32	1.00	0.25	190					
			42 HRc					120					190	130				
K Grey	7	GG20, GG40, EN-GJL-250, N030B	150 HB	0.50	2.00	0.11	0.45	170	250	0.70	1.00	0.35	200					
			200 HB					160					230	180				
			250 HB					150					210	160				
K Malleable & Nodular	8	GGG40, GGG70, 50005	150 HB	0.50	2.00	0.11	0.35	250	1.50	3.00	0.30	0.30	180					
			200 HB					230					0.50	160				
			250 HB					190					0.45	140				
S Fe, Ni & Co based	9	Incoloy 800	240 HB	0.50	1.50	0.13	0.30	25	45	0.30	1.00	0.28	32					
		Inconel 700	250 HB					45					30					
		Stellite 21	350 HB					23					40	28				
S Ti based	10	T40	-	0.50	1.50	0.13	0.32	35	55	0.32	1.00	0.30	45					
		TiAl6V4	-					0.30					45	65	0.30	0.28	55	
H Steel Chilled Cast Iron White Cast Iron	11	X100 CrMo13, 440C, G-X260NiCr42	45 HRc	0.50	1.20	0.05	0.22	50	100	0.20	0.90	0.18	80					
			50 HRc					1.00					0.18	90	0.17	0.70	0.16	70
			55 HRc		0.80			0.14					40	80	0.12	0.60	0.12	60
			400 HB		1.20			0.22					60	0.17	0.90	0.18	50	
NF Aluminium	12	AlSi12	130 HB	0.50	2.00	0.15	0.40	200	400	0.70	1.00	0.35	280					

RCMT 0803 M0

RCMT 10T3 M0

Material Group	Lamina Gr. N°	Material Examples	Hardness	DOC [mm]		Feed [mm/rev]		Vc		Amax [mm ²]	Suggested Starting Parameters								
				min	max	min	max	min	max		DOC	Feed	Vc						
P Non Alloyed Low Alloyed High Alloyed	1	C35, Ck45, 1020, 1045, 1060, 28Mn6	125 HB	0.50	2.40	0.15	0.40	180	330	0.77	1.20	0.35	240						
			190 HB						280				220						
			250 HB						250				200						
	2	42CrMo4, St50, Ck60, 4140, 4340, 100Cr6	180 HB	0.50	2.40	0.15	0.35	120	280	0.67	1.20	0.30	0.30	200					
			230 HB						250					180					
			280 HB						210					150					
			350 HB						180					130					
	3	X40CrMoV5, H13, M42, D3, S6-5-2, 12Ni19	220 HB	0.50	2.40	0.13	0.35	70	190	0.58	1.20	0.28	0.30	140					
			280 HB						150					120					
320 HB			130						100										
350 HB			110						90										
M Austenitic	4	304, 316, X5CrNi18-9	180 HB	0.50	2.40	0.14	0.35	170	0.38	1.20	0.30	0.30	190						
			240 HB					160					170						
M Duplex	5	X2CrNiN23-4, S31500	290 HB	0.50	1.80	0.13	0.30	80	0.36	1.20	0.28	0.28	100						
			310 HB					70					90						
M Ferritic & Martensitic	6	410, X6Cr17, 17-4PH, 430	200 HB	0.50	2.40	0.15	0.35	170	0.38	1.20	0.25	0.25	190						
			42 HRc					120					130						
K Grey	7	GG20, GG40, EN-GJL-250, N030B	150 HB	0.50	2.40	0.11	0.45	170	0.84	1.20	0.35	0.35	200						
			200 HB					160					180						
			250 HB					150					160						
K Malleable & Nodular	8	GGG40, GGG70, 50005	150 HB	0.50	2.40	0.11	0.35	120	0.72	1.20	0.30	0.30	180						
			200 HB					230					160						
			250 HB					190					140						
S Fe, Ni & Co based	9	Incoloy 800	240 HB	0.50	1.80	0.13	0.30	25	0.36	1.20	0.28	0.28	32						
		Inconel 700	250 HB					45					30						
		Stellite 21	350 HB					23					28						
S Ti based	10	T40	-	0.50	1.80	0.13	0.32	35	0.38	1.20	0.30	0.30	45						
		TiAl6V4	-					0.30					45	65	0.36	0.28	55		
H Steel Chilled Cast Iron White Cast Iron	11	X100 CrMo13, 440C, G-X260NiCr42	45 HRc	0.50	1.40	0.05	0.22	50	0.24	1.10	0.18	0.18	80						
			50 HRc					1.20					0.18	90	0.20	0.80	0.16	70	
			55 HRc					1.00					0.14	40	80	0.14	0.70	0.12	60
			400 HB					1.40					0.22	60	0.20	1.10	0.18	50	
NF Aluminium	12	AlSi12	130 HB	0.50	2.40	0.15	0.40	200	0.84	1.20	0.35	0.35	280						
			400					400					0.84	1.20	0.35	280			

Material Group	Lamina Gr. N°	Material Examples	Hardness	DOC [mm]		Feed [mm/rev]		Vc		Amax [mm ²]	Suggested Starting Parameters								
				min	max	min	max	min	max		DOC	Feed	Vc						
P Non Alloyed Low Alloyed High Alloyed	1	C35, Ck45, 1020, 1045, 1060, 28Mn6	125 HB	0.50	2.80	0.15	0.40	180	330	0.90	1.40	0.35	240						
			190 HB						280				220						
			250 HB						250				200						
	2	42CrMo4, St50, Ck60, 4140, 4340, 100Cr6	180 HB	0.50	2.80	0.15	0.35	120	280	0.78	1.40	0.30	0.30	200					
			230 HB						250					180					
			280 HB						210					150					
			350 HB						180					130					
	3	X40CrMoV5, H13, M42, D3, S6-5-2, 12Ni19	220 HB	0.50	2.80	0.13	0.35	70	190	0.67	1.40	0.28	0.30	140					
			280 HB						150					120					
320 HB			130						100										
350 HB			110						90										
M Austenitic	4	304, 316, X5CrNi18-9	180 HB	0.50	2.80	0.14	0.35	170	0.45	1.40	0.30	0.30	190						
			240 HB					160					170						
M Duplex	5	X2CrNiN23-4, S31500	290 HB	0.50	2.10	0.13	0.30	80	0.42	1.40	0.28	0.28	100						
			310 HB					70					90						
M Ferritic & Martensitic	6	410, X6Cr17, 17-4PH, 430	200 HB	0.50	2.80	0.15	0.35	170	0.45	1.40	0.25	0.25	190						
			42 HRc					120					130						
K Grey	7	GG20, GG40, EN-GJL-250, N030B	150 HB	0.50	2.80	0.11	0.45	170	0.98	1.40	0.35	0.35	200						
			200 HB					160					180						
			250 HB					150					160						
K Malleable & Nodular	8	GGG40, GGG70, 50005	150 HB	0.50	2.80	0.11	0.35	120	0.84	1.40	0.30	0.30	180						
			200 HB					230					160						
			250 HB					190					140						
S Fe, Ni & Co based	9	Incoloy 800	240 HB	0.50	2.10	0.13	0.30	25	0.42	1.40	0.28	0.28	32						
		Inconel 700	250 HB					45					30						
		Stellite 21	350 HB					23					28						
S Ti based	10	T40	-	0.50	2.10	0.13	0.32	35	0.45	1.40	0.30	0.30	45						
		TiAl6V4	-					0.30					45	65	0.42	0.28	55		
H Steel Chilled Cast Iron White Cast Iron	11	X100 CrMo13, 440C, G-X260NiCr42	45 HRc	0.50	1.70	0.05	0.22	50	0.28	1.30	0.18	0.18	80						
			50 HRc					1.40					0.18	90	0.24	1.00	0.16	70	
			55 HRc					1.10					0.14	40	80	0.17	0.80	0.12	60
			400 HB					1.70					0.22	60	0.24	1.30	0.18	50	
NF Aluminium	12	AlSi12	130 HB	0.50	2.80	0.15	0.40	200	0.98	1.40	0.35	0.35	280						
			400					400					0.98	1.40	0.35	280			

RCMT 1204 M0

CPMT 060208 NN
TCMT 110208 NN

Material Group	Lamina Gr. N°	Material Examples	Hardness	DOC [mm]		Feed [mm/rev]		Vc		Amax [mm ²]	Suggested Starting Parameters								
				min	max	min	max	min	max		DOC	Feed	Vc						
P Non Alloyed Low Alloyed High Alloyed	1	C35, Ck45, 1020, 1045, 1060, 28Mn6	125 HB	0.50	3.20	0.15	0.40	180	330	1.54	2.00	0.37	240						
			190 HB						280				220						
			250 HB						250				200						
	2	42CrMo4, St50, Ck60, 4140, 4340, 100Cr6	180 HB	0.50	3.20	0.15	0.35	120	280	1.34	2.00	0.32	200						
			230 HB						250					180					
			280 HB						210					150					
			350 HB						180					130					
	3	X40CrMoV5, H13, M42, D3, S6-5-2, 12Ni19	220 HB	0.50	3.20	0.13	0.35	70	190	1.15	2.00	0.32	140						
			280 HB						150					120					
320 HB			130						100										
350 HB			110						90										
M Austenitic	4	304, 316, X5CrNi18-9	180 HB	0.50	3.20	0.14	0.35	170	270	2.00	0.32	190							
			240 HB					160					170						
M Duplex	5	X2CrNiN23-4, S31500	290 HB	0.50	2.40	0.13	0.30	80	150	2.00	0.29	100							
			310 HB					70					90						
M Ferritic & Martensitic	6	410, X6Cr17, 17-4PH, 430	200 HB	0.50	3.20	0.15	0.35	170	250	2.00	0.26	190							
			42 HRc					120					130						
K Grey	7	GG20, GG40, EN-GJL-250, N030B	150 HB	0.50	3.20	0.11	0.45	170	250	2.00	0.37	200							
			200 HB					160					180						
			250 HB					150					160						
K Malleable & Nodular	8	GGG40, GGG70, 50005	150 HB	0.50	3.20	0.11	0.35	120	250	2.00	0.32	180							
			200 HB					230					160						
			250 HB					190					140						
S Fe, Ni & Co based	9	Incoloy 800	240 HB	0.50	2.40	0.13	0.30	25	45	2.00	0.29	32							
		Inconel 700	250 HB					45					30						
		Stellite 21	350 HB					23					28						
S Ti based	10	T40	-	0.50	2.40	0.13	0.32	35	55	2.00	0.32	45							
		TiAl6V4	-					0.30					45	65	0.72	0.29	55		
H Steel Chilled Cast Iron White Cast Iron	11	X100 CrMo13, 440C, G-X260NiCr42	45 HRc	0.50	1.90	0.05	0.22	50	100	0.48	1.80	0.19	80						
			50 HRc					1.60					0.18	90	0.41	1.40	0.17	70	
			55 HRc					1.30					0.14	40	80	0.29	1.20	0.13	60
			400 HB					1.90					0.22	60	0.41	1.80	0.19	50	
NF Aluminium	12	AlSi12	55 HRc	0.30	1.30	0.14	0.30	50	50	0.24	1.20	0.13	40						
			130 HB					0.50					3.20	0.15	0.40	200	400	1.68	2.00

Material Group	Lamina Gr. N°	Material Examples	Hardness	DOC [mm]		Feed [mm/rev]		Vc		Amax [mm ²]	Suggested Starting Parameters								
				min	max	min	max	min	max		DOC	Feed	Vc						
P Non Alloyed Low Alloyed High Alloyed	1	C35, Ck45, 1020, 1045, 1060, 28Mn6	125 HB	0.30	2.10	0.08	0.20	180	330	0.37	2.00	0.14	240						
			190 HB						280				220						
			250 HB						250				200						
	2	42CrMo4, St50, Ck60, 4140, 4340, 100Cr6	180 HB	0.30	1.80	0.08	0.17	120	280	1.34	2.00	0.32	200						
			230 HB						250					180					
			280 HB						210					150					
			350 HB						180					130					
	3	X40CrMoV5, H13, M42, D3, S6-5-2, 12Ni19	220 HB	0.30	1.80	0.07	0.15	70	190	1.15	2.00	0.32	140						
			280 HB						150					120					
320 HB			130						100										
350 HB			110						90										
M Austenitic	4	304, 316, X5CrNi18-9	180 HB	0.30	1.80	0.06	0.15	170	270	2.00	0.32	190							
			240 HB					160					170						
M Duplex	5	X2CrNiN23-4, S31500	290 HB	0.30	1.40	0.06	0.12	80	150	2.00	0.29	100							
			310 HB					70					90						
M Ferritic & Martensitic	6	410, X6Cr17, 17-4PH, 430	200 HB	0.30	1.80	0.06	0.15	170	250	2.00	0.26	190							
			42 HRc					120					130						
K Grey	7	GG20, GG40, EN-GJL-250, N030B	150 HB	0.30	2.10	0.06	0.17	170	250	2.00	0.37	200							
			200 HB					160					180						
			250 HB					150					160						
K Malleable & Nodular	8	GGG40, GGG70, 50005	150 HB	0.30	1.80	0.06	0.15	120	250	2.00	0.32	180							
			200 HB					230					160						
			250 HB					190					140						
S Fe, Ni & Co based	9	Incoloy 800	240 HB	0.30	1.40	0.07	0.13	25	45	2.00	0.29	32							
		Inconel 700	250 HB					45					30						
		Stellite 21	350 HB					23					28						
S Ti based	10	T40	-	0.30	1.40	0.07	0.14	35	55	2.00	0.32	45							
		TiAl6V4	-					0.12					45	65	0.16	0.70	0.08	55	
H Steel Chilled Cast Iron White Cast Iron	11	X100 CrMo13, 440C, G-X260NiCr42	45 HRc	0.30	1.30	0.04	0.10	50	100	0.48	1.80	0.19	80						
			50 HRc					1.10					0.09	90	0.41	1.40	0.17	70	
			55 HRc					1.00					0.08	40	80	0.29	1.20	0.13	60
			400 HB					1.10					0.10	60	0.41	1.80	0.19	50	
NF Aluminium	12	AlSi12	55 HRc	0.30	1.00	0.08	0.08	30	50	0.24	1.20	0.13	40						
			130 HB					0.30					2.80	0.08	0.26	200	400	1.68	2.00

LT 1110S - NS CHIPBREAKER

MATERIAL GROUP		LAMINA GR. N°	MATERIAL EXAMPLE	HARDNESS
NiTi Alloy	Ti Based	10	TiAl6V4	-
			T40	-

DESIGNATION	MATERIAL EXAMPLE	DOC (mm)		FEED (mm/t)		Vc (m/min)		Amax (mm^2)	SUGGESTED STARTING PARAMETERS		
		min	max	min	max	min	max		doc (mm)	feed (mm/t)	Vc (m/mm)
CCGT 060204 NS	TiAl6V4	0.30	1.00	0.05	0.10	40	60	0.07	0.50	0.08	50
	T40					50	70				60
CCGT 09T304 NS CNGG 09T304 NS	TiAl6V4	0.30	1.80	0.06	0.12	40	60	0.15	1.30	0.10	50
	T40				0.14	50	70	0.18		0.12	60
CNGG 120404 NS	TiAl6V4	0.30	2.00	0.06	0.14	40	60	0.20	1.50	0.11	50
	T40				0.16	50	70	0.22		0.13	60
CNGG 120408 NS	TiAl6V4	0.50	3.50	0.18	0.40	40	60	0.98	2.50	0.28	45
	T40				0.43	50	70	1.05		0.30	55
DCGT 11T304 NS DNGG 150604 NS	TiAl6V4	0.30	1.50	0.06	0.12	40	60	0.13	1.00	0.10	50
	T40				0.14	50	70	0.15		0.12	60
DNGG 110404 NS	TiAl6V4	0.30	1.70	0.06	0.12	40	60	0.14	1.30	0.10	50
	T40				0.14	50	70	0.17		0.12	60
DNGG 110408 NS	TiAl6V4	0.50	3.00	0.15	0.30	40	60	0.63	2.00	0.20	45
	T40				0.32	50	70	0.67		0.23	55
DNGG 150608 NS	TiAl6V4	0.50	2.30	0.14	0.36	40	60	0.58	1.20	0.25	45
	T40				0.38	50	70	0.61	1.40	0.28	55
TNGG 160404 NS	TiAl6V4	0.30	2.00	0.06	0.14	40	60	0.20	1.50	0.11	50
	T40				0.16	50	70	0.22		0.13	60
TNGG 160408 NS	TiAl6V4	0.50	3.50	0.18	0.40	40	60	0.98	2.50	0.28	45
	T40				0.43	50	70	1.05		0.30	55
VCGT 160404 NS VNGG 160404 NS	TiAl6V4	0.30	1.50	0.06	0.12	40	60	0.13	0.80	0.10	50
	T40				0.14	50	70	0.15		0.11	60
VNGG 160408 NS	TiAl6V4	0.50	2.00	0.14	0.34	40	60	0.48	1.00	0.23	45
	T40				0.36	50	70	0.50	1.20	0.25	55
WNGG 060404 NS	TiAl6V4	0.30	1.70	0.06	0.14	40	60	0.17	1.10	0.10	50
	T40				0.12	50	70	0.14		0.12	60
WNGG 060408 NS WNGG 080408 NS	TiAl6V4	0.50	2.30	0.15	0.30	40	60	0.48	1.60	0.20	45
	T40				0.32	50	70	0.52		0.23	55
WNGG 080404 NS	TiAl6V4	0.30	2.50	0.06	0.14	40	60	0.25	1.60	0.11	50
	T40				0.16	50	70	0.28		0.13	60

LT 1110S - NX CHIPBREAKER

MATERIAL GROUP		LAMINA GR. N°	MATERIAL EXAMPLE	HARDNESS
NiTi Alloy	Fe, Ni & Co Based	9	Incoloy 800	240 HB
			Inconel 700	250 HB
			Stellite 21	350 HB
	Ti Based	10	TiAl6V4	-
T40			-	

DESIGNATION	MATERIAL EXAMPLE	DOC (mm)		FEED (mm/t)		Vc (m/min)		Amax (mm^2)	SUGGESTED STARTING PARAMETERS				
		min	max	min	max	min	max		doc (mm)	feed (mm/t)	Vc (m/mm)		
CNMG 120408 NX DNMG 150408 NX DNMG 150608 NX TNMG 160408 NX	Incoloy 800	0.50	3.00	0.18	0.35	30	50	0.67	2.00	0.27	30		
	Inconel 700					20	40						
	Stellite 21					0.40	50					70	0.76
	TiAl6V4					0.35	40					60	0.67
TNMG 160408 NX	Incoloy 800	0.50	3.00	0.18	0.49	30	50	0.94	2.00	0.38	30		
	Inconel 700					20	40						
	Stellite 21					0.56	50					70	1.07
	TiAl6V4					0.49	40					60	0.94
TNMG 220408 NX	Incoloy 800	0.50	4.20	0.18	0.35	30	50	0.67	2.00	0.27	30		
	Inconel 700					20	40						
	Stellite 21					0.40	50					70	0.76
	TiAl6V4					0.35	40					60	0.67
WNGG 060408 NX	Incoloy 800	0.50	1.50	0.18	0.35	30	50	0.44	1.20	0.27	30		
	Inconel 700					20	40						
	Stellite 21					0.40	50					70	0.50
	TiAl6V4					0.35	40					60	0.44
WNGG 080408 NX	Incoloy 800	0.50	2.10	0.18	0.35	30	50	0.67	1.60	0.27	30		
	Inconel 700					20	40						
	Stellite 21					0.40	50					70	0.76
	TiAl6V4					0.35	40					60	0.67
CNMG 120404 NN DNMG 150404 NN	Incoloy 800	0.30	2.00	0.09	0.15	30	50	0.26	1.30	0.10	40		
	Inconel 700					20	40						
	Stellite 21					0.16	50				70	0.32	
	TiAl6V4					0.14	40				60	0.26	
T40											50		

LT 1110S - NN CHIPBREAKER

MATERIAL GROUP		LAMINA GR. N°	MATERIAL EXAMPLE	HARDNESS
NiTi Alloy	Fe, Ni & Co Based	9	Incoloy 800	240 HB
			Inconel 700	250 HB
			Stellite 21	350 HB
	Ti Based	10	TiAl6V4	-
			T40	-

LT 1120M - NX CHIPBREAKER

MATERIAL GROUP		LAMINA GROUP	MATERIAL EXAMPLE	HARDNESS
Stainless Steel	Austenitic	4	304, 316, X5CrNi18-9	180 HB
				240 HB
	Duplex	5	X2CrNiN23-4, S31500	290 HB
				310 HB
	Ferritic & Martensitic	6	410, X6Cr17, 17-4 PH, 430	200 HB
				42 HRc

DESIGNATION	MATERIAL EXAMPLE	DOC (mm)		FEED (mm/t)		Amax (mm ²)	Vc (m/min)		SUGGESTED STARTING PARAMETERS		
		min	max	min	max		min	max	doc (mm)	feed (mm/t)	Vc (m/min)
CNMG 120412 NN DNMG 150412 NN DNMG 150612 NN	Incoloy 800	0.70	3.60	0.25	0.47	30	50	1.19	2.70	0.37	32
	Inconel 700										30
	Stellite 21										28
	TiAl6V4										55
	T40										45
DNMG 150604 NN TNMG 160404 NN	Incoloy 800	0.30	2.00	0.09	0.15	30	50	0.26	1.30	0.10	40
	Inconel 700										35
	Stellite 21										60
	TiAl6V4										50
TNMG 160412 NN	Incoloy 800	0.70	3.00	0.25	0.47	30	50	1.19	2.40	0.37	30
	Inconel 700										40
	Stellite 21										40
	TiAl6V4										55
	T40										45
TNMG 220412 NN	Incoloy 800	0.70	4.20	0.25	0.47	30	50	1.19	2.70	0.37	30
	Inconel 700										40
	Stellite 21										40
	TiAl6V4										55
	T40										45
TNMG 220404 NN WNMG 060404 NN WNMG 080404 NN	Incoloy 800	0.30	2.00	0.09	0.15	30	50	0.26	1.30	0.10	40
	Inconel 700										35
	Stellite 21										60
	TiAl6V4										50
	T40										50
WNMG 080412 NN	Incoloy 800	0.70	2.10	0.24	0.46	30	50	0.84	1.70	0.35	30
	Inconel 700										40
	Stellite 21										40
	TiAl6V4										55
	T40										45

DESIGNATION	MATERIAL EXAMPLE	DOC (mm)		FEED (mm/t)		Amax (mm ²)	Vc (m/min)		SUGGESTED STARTING PARAMETERS											
		min	max	min	max		min	max	doc (mm)	feed (mm/t)	Vc (m/min)									
CNMG 120408 NX CNMP 120408 NX DNMG 110408 NX DNMG 150408 NX TNMG 160408 NX TNMG 220408 NX	304, 316, X5CrNi18-9	0.50	5.00	0.18	0.40	1.14	90	270	3.00	0.24	190									
											X2CrNiN23-4, S31500	4.00	0.16	0.35	0.76	40	150	2.50	0.23	100
																				410, X6Cr17, 17-4 PH, 430
	SNMG 120408 NX	0.50	5.00	0.25	0.56	1.61	90	270	3.00	0.34	190									
											X2CrNiN23-4, S31500	4.00	0.25	0.49	1.07	40	150	2.50	0.32	100
																				410, X6Cr17, 17-4 PH, 430
WNMG 060408 NX WNMG 080408 NX	304, 316, X5CrNi18-9	0.50	2.50	0.18	0.40	1.14	90	270	1.80	0.24	190									
											X2CrNiN23-4, S31500	2.00	0.16	0.35	0.76	40	150	1.50	0.23	100
																				410, X6Cr17, 17-4 PH, 430
	X2CrNiN23-4, S31500	2.00	0.16	0.35	0.76	40	140	1.50	0.23	0.19	130									
											410, X6Cr17, 17-4 PH, 430	2.50	0.16	0.40	0.67	60	190	1.30	0.19	130

LT 1120M - NN CHIPBREAKER

MATERIAL GROUP	LAMINA GROUP	MATERIAL EXAMPLE	HARDNESS	
Stainless Steel	Austenitic	304, 316, X5CrNi18-9	180 HB	
			240 HB	
	Duplex	X2CrNiN23-4, S31500	290 HB	
			310 HB	
	Ferritic & Martensitic	6	410, X6Cr17, 17-4 PH, 430	200 HB
				42 HRc

DESIGNATION	MATERIAL EXAMPLE	DOC (mm)		FEED (mm/t)		Amax (mm ²)		Vc (m/min)		SUGGESTED STARTING PARAMETERS		
		min	max	min	max	min	max	min	max	doc (mm)	feed (mm/t)	Vc (m/mm)
CNMP 120408 NN DNMG 110408 NN	304, 316, X5CrNi18-9	0.50	5.00	0.20	0.40	1.20	90	270	3.00	0.25	190	
						1.00	80	220		0.22	170	
						150	140	2.50		0.24	100	
	410, X6Cr17, 17-4 PH, 430	0.50	4.00	0.18	0.40	0.70	90	250	2.50	0.20	190	
							60	190	2.20		130	
							150	140	2.50		0.24	100
CNMG 120412 NN CNMP 120412 NN DNMG 150412 NN DNMG 150612 NN TNMG 160412 NN TNMG 220412 NN	304, 316, X5CrNi18-9	0.70	6.00	0.25	0.54	2.04	90	270	4.00	0.33	190	
						1.70	80	220		0.29	170	
						40	150	3.40		0.32	100	
	X2CrNiN23-4, S31500	0.70	4.80	0.23	0.47	1.36	40	150	3.40	0.32	90	
							40	140			190	
							150	140			2.90	0.26
410, X6Cr17, 17-4 PH, 430	0.70	6.00	0.23	0.54	1.30	90	250	3.40	0.26	190		
						60	190			2.90	130	
						150	140			2.90	0.26	130
SNMG 120412 NN	304, 316, X5CrNi18-9	0.70	6.00	0.35	0.76	2.64	90	270	4.00	0.50	190	
						2.20	80	220		0.43	170	
						150	140	3.40		0.45	100	
	X2CrNiN23-4, S31500	0.70	4.80	0.34	0.67	1.76	40	150	3.40	0.45	90	
							40	140			190	
							150	140			2.90	0.40
410, X6Cr17, 17-4 PH, 430	0.70	6.00	0.32	0.70	1.54	90	250	3.40	0.40	190		
						60	190			2.90	130	
						150	140			2.90	0.40	130
WNMG 080412 NN	304, 316, X5CrNi18-9	0.70	3.50	0.24	0.52	1.44	90	270	2.60	0.31	190	
						1.20	80	220		0.28	170	
						150	140	2.10		0.30	100	
	X2CrNiN23-4, S31500	0.70	2.80	0.22	0.46	0.96	40	150	2.10	0.30	90	
							40	140			190	
							150	140			2.10	0.25
410, X6Cr17, 17-4 PH, 430	0.70	3.50	0.22	0.50	0.84	90	250	2.10	0.25	190		
						60	190			1.90	130	
						150	140			1.90	0.25	130

LT 1125P

MATERIAL GROUP	LAMINA GROUP	MATERIAL EXAMPLE	HARDNESS	
Steel	Non-alloyed	1	C35, Ck45, 1020, 1045, 1060, 28Mn6	
			125 HB	
			190 HB	
	Low alloyed	2	42CrMo4, St50, Ck60, 4140, 4340, 100Cr6	250 HB
				180 HB
				230 HB
				280 HB
				350 HB
	High alloyed	3	X40CrMoV5, H13, M42, D3, S6-5-2, 12Ni19	220 HB
				280 HB
				320 HB
				350 HB

DESIGNATION	MATERIAL EXAMPLE	DOC (mm)		FEED (mm/t)		Amax (mm ²)		Vc (m/min)		SUGGESTED STARTING PARAMETERS		
		min	max	min	max	min	max	min	max	doc (mm)	feed (mm/t)	Vc (m/mm)
CNMG 120404 MP DNMG 110404 MP DNMG 150404 MP DNMG 150604 MP TNMG 160404 MP VNMG 160404 MP WNMG 080404 MP	C35, Ck45, 1020, 1045, 1060, 28Mn6	0.30	3.00	0.11	0.23	0.60	90	330	2.00	0.18	240	
											280	
											250	
											200	
											280	
											250	
	42CrMo4, St50, Ck60, 4140, 4340, 100Cr6	0.30	2.50	0.10	0.20	0.50	60	280	2.00	0.14	200	
											250	
											210	
											180	
											180	
											180	
X40CrMoV5, H13, M42, D3, S6-5-2, 12Ni19	0.30	2.50	0.09	0.18	0.40	35	190	1.70	0.10	140		
										150		
										130		
										100		
										110		
										110		
CNMG 120408 MP DNMG 110408 MP DNMG 150408 MP DNMG 150608 MP SNMG 120408 MP TNMG 160408 MP TNMG 220408 MP VNMG 160408 MP	C35, Ck45, 1020, 1045, 1060, 28Mn6	0.50	5.00	0.18	0.50	1.71	90	330	3.00	0.36	240	
											280	
											250	
											200	
											280	
											250	
	42CrMo4, St50, Ck60, 4140, 4340, 100Cr6	0.50	5.00	0.18	0.45	1.14	60	280	3.00	0.30	200	
											250	
											210	
											180	
											180	
											180	
X40CrMoV5, H13, M42, D3, S6-5-2, 12Ni19	0.50	4.00	0.16	0.40	0.95	35	190	2.50	0.29	140		
										150		
										130		
										100		
										110		
										110		
X40CrMoV5, H13, M42, D3, S6-5-2, 12Ni19	0.50	4.00	0.16	0.40	1.14	35	190	2.50	0.29	140		
										150		
										130		
										100		
										110		
										110		
X40CrMoV5, H13, M42, D3, S6-5-2, 12Ni19	0.50	3.00	0.16	0.35	0.76	35	190	2.50	0.27	100		
										150		
										130		
										100		
										110		
										110		

LT 05 - NON FERROUS TURNING

DESIGNATION	MATERIAL EXAMPLE	DOC (mm)		FEED (mm/t)		Amax (mm^2)	Vc (m/min)		SUGGESTED STARTING PARAMETERS				
		min	max	min	max		min	max	doc (mm)	feed (mm/t)	Vc (m/mm)		
WNMG 060408 MP WNMG 080408 MP	C35, Ck45, 1020, 1045, 1060, 28Mn6	0.50	2.50	0.18	0.50	1.13	90	330	1.80	0.36	240		
					0.45	0.95		280		0.33	220		
					0.45	0.95		250		0.31	200		
			42CrMo4, St50, Ck60, 4140, 4340, 100Cr6	0.18	0.45	0.76	60	280	1.80	200	0.30	200	180
								250		180		150	
								210		150		130	
	X40CrMoV5, H13, M42, D3, S6-5-2, 12Ni19	0.16	0.40	0.76	35	190	1.50	140	0.29	140	120		
						150		120		100			
						130		100		90			
	CNMG 120412 MP DNMG 150412 MP DNMG 150612 MP TNMG 160404 MP SNMG 120412 MP TNMG 160412 MP TNMG 220412 MP	C35, Ck45, 1020, 1045, 1060, 28Mn6	0.70	6.00	0.26	0.68	3.06	90	330	4.00	0.50	240	
						0.61	2.55		280		0.46	220	
						0.61	2.55		250		0.44	200	
42CrMo4, St50, Ck60, 4140, 4340, 100Cr6				0.26	0.61	2.04	60	280	4.00	200	0.42	200	180
								250		180		150	
								210		150		130	
X40CrMoV5, H13, M42, D3, S6-5-2, 12Ni19		0.22	0.54	1.70	35	180	3.60	140	0.40	140	120		
						150		120		100			
						130		100		90			
WNMG 080412 MP		C35, Ck45, 1020, 1045, 1060, 28Mn6	0.70	3.50	0.25	0.65	2.16	90	330	2.60	0.48	240	
						0.59	1.80		280		0.44	220	
						0.59	1.80		250		0.41	200	
	42CrMo4, St50, Ck60, 4140, 4340, 100Cr6			0.25	0.59	1.44	60	280	2.60	200	0.40	200	180
								250		180		150	
								210		150		130	
	X40CrMoV5, H13, M42, D3, S6-5-2, 12Ni19	0.22	0.52	1.20	35	180	2.30	140	0.38	140	120		
						150		120		100			
						130		100		90			
	CNMG 160616 MP	C35, Ck45, 1020, 1045, 1060, 28Mn6	1.50	7.60	0.44	0.80	4.40	90	330	6.00	0.70	240	
						0.78	4.20		280		0.65	220	
						0.78	4.20		250		0.62	200	
42CrMo4, St50, Ck60, 4140, 4340, 100Cr6				0.42	0.74	4.00	60	280	6.00	200	0.60	200	180
								250		180		150	
								210		150		130	
X40CrMoV5, H13, M42, D3, S6-5-2, 12Ni19		0.40	0.70	3.40	35	180	5.50	140	0.53	140	120		
						150		120		100			
						130		100		90			

MATERIAL GROUP	LAMINA GR. N°	MATERIAL EXAMPLE	HARDNESS	
Non Ferrous	13	Si < 4%	100 HB	
			60 HB	
	14	CuZn30	100 HB	
	15	Fiber Plastics	-	
			Hard Rubber	-
			Graphite	-

DESIGNATION	MATERIAL EXAMPLE	DOC (mm)		FEED (mm/t)		Amax (mm^2)	Vc (m/min)		SUGGESTED STARTING PARAMETERS								
		min	max	min	max		min	max	doc (mm)	feed (mm/t)	Vc (m/mm)						
CCGT 060204 NS	Si < 4%	0.30	2.50	0.10	0.29	1.02	250	600	1.50	0.23	300						
											0.12	0.33	1.28	400	1,200	400	
	0.10			0.19	1.02	80	300	1.20			0.15	250					
												70	500				
												80	300				
												100	200				
CCGT 09T304 NS	Si < 4%	0.30	4.50	0.10	0.30	1.20	250	600	2.50	0.23	300						
											0.12	0.35	1.50	400	1,200	400	
	0.10			0.20	1.20	70	500	2.00			0.15	250					
												150	800				
												80	300				
												100	200				
CNGG 120408 NS	Si < 4%	0.50	6.00	0.50	2.10	400	1,200	250	4.00	0.36	400						
											0.60	2.52	150	800	300		
	0.18			0.36	1.39	70	500	3.50			0.24	250					
												0.40	1.68	100	200	4.00	0.26
												0.40	1.68	100	200	4.00	0.26
												0.34	0.95	80	300	3.00	0.22
CNGG 09T304 NS DNGG 110404 NS TNGG 160404 NS VCGT 160404 NS VNGG 160404 NS WNGG 080404 NS	Si < 4%	0.30	4.50	0.30	0.95	400	1,200	250	2.30	0.27	400						
											0.35	1.10	150	800	300		
	0.10			0.27	0.85	70	500	2.30			0.20	250					
												0.22	0.69	100	200	0.16	
												0.22	0.69	100	200	0.16	
												0.26	0.73	80	300	1.60	0.18
DCGT 11T304 NS	Si < 4%	0.30	4.50	0.10	0.30	1.20	250	600	2.30	0.23	300						
											0.12	0.35	1.50	400	1,200	400	
	0.10			0.30	1.20	70	500	1.80			0.15	250					
												150	800				
												80	300				
												100	200				

DESIGNATION	MATERIAL EXAMPLE	DOC (mm)		FEED (mm/t)		Amax (mm^2)		Vc (m/min)		SUGGESTED STARTING PARAMETERS		
		min	max	min	max	min	max	min	max	doc (mm)	feed (mm/t)	Vc (m/mm)
DNGG 110408 NS	Si < 4%	0.50	5.00	0.18	0.46	1.61	400	1,200	3.00	0.30	400	
					0.60	2.10	150	800				3.00
					0.38	1.20	70	500	2.80	0.24	150	
					0.40	1.40	100	200	3.00	0.28		
	Graphite	4.00	0.34	0.95	80	300	2.50	0.22				
DNGG 150604 NS	Si < 4%	0.30	5.50	0.10	0.10	0.30	1.40	250	600	2.50	0.23	300
					0.12	0.35	1.80	400	1,200			400
					0.30	0.30	150	800	250			
					0.10	0.20	1.40	70	500	2.00	0.15	150
	80	300	100	200								
DNGG 150608 NS WNGG 080408 NS	Si < 4%	0.50	5.50	0.18	0.50	1.40	250	600	3.00	0.32	300	
					0.60	1.80	400	1,200			400	
					0.15	0.40	1.40	150	800	0.25	150	
					80	300	100	200				
	Graphite	4.00	0.34	0.95	80	300	1.60	0.22				
TNGG 160408 NS	Si < 4%	0.30	4.50	0.18	0.50	1.58	400	1,200	2.30	0.36	400	
					0.60	1.89	150	800			250	
					0.36	1.13	70	500	1.50	0.24	150	
					0.40	1.26	100	200				0.26
	Graphite	4.00	0.34	0.95	80	300	1.60	0.22				
WNGG 060404 NS	Si < 4%	0.30	3.00	0.10	0.30	0.95	400	1,200	1.80	0.27	400	
					0.35	1.10	150	800			250	
					0.27	0.85	70	500	0.20	150		
					0.22	0.69	100	200			0.16	
	Graphite	2.5	0.26	0.73	80	300	1.60	0.18				
WNGG 060408 NS	Si < 4%	0.50	3.00	0.18	0.50	1.40	250	600	1.80	0.32	300	
					0.60	1.80	400	1,200			400	
					0.15	0.40	1.40	150	800	0.25	150	
					70	500	80	300				
	Graphite	4.00	0.34	0.95	80	300	1.60	0.22				

GCTX 2002 NN
GCTX 3003 NN
GCTX 3003 PP

Material Group	Lamina Gr. N°	Material Examples	Hardness	LT 1000 Vc [m/min]		GCTX 2002 NN Feed [mm/rev]		GCTX 3003 NN Feed [mm/rev]		GCTX 3003 PP Feed [mm/rev]			
				min	max	min	max	min	max	min	max		
Non Alloyed	1	C35, Ck45, 1020, 1045, 1060, 28Mn6	125 HB	130	220	0.50	0.17	0.05	0.17	0.05	0.17		
			190 HB									220	
			250 HB									200	
Low Alloyed P	2	42CrMo4, S150, Ck60, 4140, 4340, 100Cr6	180 HB	90	200	0.50	0.15	0.05	0.15	0.05	0.15		
			230 HB									170	
			280 HB									150	
			350 HB									150	
High Alloyed	3	X40CrMoV5, H13, M42, D3, S6-5-2, 12Ni19	220 HB	60	170	0.50	0.14	0.05	0.14	0.05	0.14		
			280 HB									130	
			320 HB									100	
			350 HB									100	
Austenitic	4	304, 316, X5CrNi18-9	180 HB	90	150	0.50	0.10	0.05	0.10	0.05	0.10		
			240 HB									70	140
M Duplex	5	X2CrNiN23-4, S31500	290 HB	60	100	0.50	0.09	0.05	0.09	0.05	0.09		
			310 HB										
Ferritic & Martensitic	6	410, X6Cr17, 17-4PH, 430	200 HB	60	130	0.50	0.09	0.05	0.09	0.05	0.09		
			42 HRc									50	90
Grey	7	GG20, GG40, EN-GJL-250, N030B	150 HB	130	190	0.50	0.16	0.05	0.16	0.05	0.16		
			200 HB										
			250 HB										
K Malleable & Nodular	8	GGG40, GGG70, 50005	150 HB	90	150	0.50	0.14	0.05	0.14	0.05	0.14		
			200 HB										
			250 HB										
S Fe, Ni & Co based	9	Incoloy 800, Inconel 700, Stellite 21	240 HB	30	40	0.50	0.08	0.05	0.08	0.05	0.08		
			250 HB										
			350 HB										
Ti based	10	T40, TiAl6V4	-	40	60	0.50	0.08	0.05	0.08	0.05	0.08		
			-									30	40
H Steel, Chilled Cast Iron, White Cast Iron	11	X100 CrMo13, 440C, G-X260NiCr42, Ni-Hard 2, G-X300CrMo15	45 HRc	50	90	0.50	0.11	0.05	0.11	0.05	0.11		
			50 HRc									40	70
			55 HRc									30	60
			400 HB									40	
55 HRc	30	50	0.08	0.08									
NF Aluminium	12	AlSi12	130 HB	100	300	0.50	0.10	0.05	0.11	0.05	0.11		

MGMN 200 G
MGMN 300 M

MGMN 400 M
MGMN 500 M

Material Group	Lamina Gr. N°	Material Examples	Hardness	LT10		MGMN 200 G Feed [mm/rev]		MGMN 300 M Feed [mm/rev]		MGMN 400 M Feed [mm/rev]		MGMN 500 M Feed [mm/rev]							
				Vc [m/min]	min	max	min	max	min	max	min	max	min	max					
															min	max			
P Non Alloyed Low Alloyed High Alloyed	1	C35, Ck45, 1020, 1045, 1060, 28Mn6	125 HB	110	220	0.06	0.21	0.07	0.25	0.13	0.35	0.20	0.41						
			190 HB											180	0.20	0.24	0.30	0.33	0.40
			250 HB																
	2	42CrMo4, S150, Ck60, 4140, 4340, 100Cr6	180 HB	70	180	0.05	0.18	0.06	0.22	0.12	0.30	0.18	0.36						
			230 HB											170	0.20	0.24	0.27	0.32	
			280 HB																140
	350 HB	120	0.16	0.20	0.27	0.32													
	3						X40CrMoV5, H13, M42, D3, S6-5-2, 12Ni19	220 HB	40	130	0.05	0.14	0.05	0.18	0.11	0.24	0.16	0.29	
		280 HB	100	0.13	0.15	0.21		0.25											
320 HB		90																	0.13
350 HB	70		0.13	0.15	0.21	0.25													
4		304, 316, X5CrNi18-9					180 HB	100	180	0.05	0.16	0.06	0.20	0.12	0.27	0.18	0.32		
	240 HB		150	0.16	0.06	0.20	0.12											0.27	0.18
5	X2CrNiN23-4, S31500	290 HB						50	100	0.05	0.13	0.05	0.15	0.11	0.21	0.16	0.25		
		310 HB	40	90	0.13	0.05	0.15	0.11	0.21									0.16	0.25
6	410, X6Cr17, 17-4PH, 430	200 HB	100	170						0.05	0.16	0.06	0.20	0.12	0.27	0.18	0.32		
		42 HRc	70	130	0.16	0.06	0.20	0.12	0.27									0.18	0.32
7	GG20, GG40, EN-GJL-250, N030B	150 HB	100	170						0.04	0.18	0.05	0.22	0.10	0.30	0.14	0.36		
		200 HB			150	0.36													
		250 HB					90	140	0.36										
8	GGG40, GGG70, 50005	150 HB	70	170	0.04	0.16				0.05	0.20	0.10	0.27	0.14	0.32				
		200 HB					150	0.32											
		250 HB							130							0.32			
9	Incoloy 800	240 HB	20	40	0.05	0.14	0.05	0.17		0.11	0.23	0.16	0.27						
		Inconel 700							40					0.27					
		Stellite 21													30	0.27			
10	TiAl6V4	-	30	40	0.05	0.14	0.05	0.18	0.11	0.24	0.16	0.29							
		-	20	40									0.14	0.05	0.18	0.11	0.24	0.16	0.29
11	X100 CrMo13, 440C, G-X260NiCr42	45 HRc	30	70	0.03	0.08	0.03	0.10	0.06	0.14	0.09	0.16							
		50 HRc											60	0.11					
		55 HRc													50	0.10			
		Ni-Hard 2															40	0.11	
		G-X300CrMo15																	20
12	AISI12	130 HB	120	260	0.05	0.27	0.06	0.33	0.12	0.45	0.18	0.54							

When using grooving inserts for side turning, the cutting depth is dependent upon the width of insert, the material and the rigidity of the workpiece.

Depth of cut recommendation:

- Max Ap (d.o.c.) is equal to 70% of insert width
- Min Ap (d.o.c.) is equal to the corner radius

WGE 2000
WGE 3000

WGE 4000
WGE 5000

Material Group	Lamina Gr. N°	Material Examples	Hardness	LT10		WGE 2000 Feed [mm/rev]		WGE 3000 Feed [mm/rev]		WGE 4000 Feed [mm/rev]		WGE 5000 Feed [mm/rev]						
				Vc [m/min]	min	max	min	max	min	max	min	max	min	max				
															min	max		
P Non Alloyed Low Alloyed High Alloyed	1	C35, Ck45, 1020, 1045, 1060, 28Mn6	125 HB	110	220	0.04	0.12	0.07	0.24	0.08	0.26	0.08	0.30					
			190 HB											180	0.11	0.23	0.25	0.29
			250 HB															
	2	42CrMo4, S150, Ck60, 4140, 4340, 100Cr6	180 HB	70	180	0.04	0.10	0.06	0.21	0.07	0.23	0.07	0.26					
			230 HB											170	0.09	0.19	0.21	0.23
			280 HB															
	350 HB	120	0.09	0.19	0.21	0.23												
	3						X40CrMoV5, H13, M42, D3, S6-5-2, 12Ni19	220 HB	40	130	0.04	0.08	0.05	0.17	0.06	0.18	0.06	0.21
		280 HB	100	0.08	0.15	0.16		0.18										
320 HB		90																
350 HB	70		0.07	0.15	0.16	0.18												
4		304, 316, X5CrNi18-9					180 HB	100	180	0.04	0.09	0.06	0.19	0.07	0.21	0.07	0.23	
	240 HB		150	0.09	0.19	0.07	0.21											0.07
5	X2CrNiN23-4, S31500	290 HB						50	100	0.04	0.07	0.05	0.15	0.06	0.16	0.06	0.18	
		310 HB	40	90	0.15	0.06	0.16	0.06	0.18									
6	410, X6Cr17, 17-4PH, 430	200 HB	100	170						0.04	0.09	0.06	0.19	0.07	0.21	0.07	0.23	
		42 HRc	70	130	0.19	0.06	0.21	0.07	0.23									
7	GG20, GG40, EN-GJL-250, N030B	150 HB	100	170						0.03	0.10	0.05	0.21	0.06	0.23	0.06	0.26	
		200 HB			150	0.26												
		250 HB					90	140	0.26									
8	GGG40, GGG70, 50005	150 HB	70	170	0.03	0.09				0.05	0.19	0.06	0.21	0.06	0.23			
		200 HB					150	0.23										
		250 HB							130							0.23		
9	Incoloy 800	240 HB	20	40	0.04	0.08	0.05	0.16		0.06	0.17	0.06	0.20					
		Inconel 700							40					0.20				
		Stellite 21													30	0.20		
10	TiAl6V4	-	30	40	0.04	0.08	0.05	0.17	0.06	0.18	0.06	0.21						
		-	20	40									0.17	0.06	0.18	0.06	0.21	
11	X100 CrMo13, 440C, G-X260NiCr42	45 HRc	30	70	0.03	0.05	0.03	0.10	0.06	0.14	0.09	0.16						
		50 HRc											60	0.11				
		55 HRc													50	0.10		
		Ni-Hard 2															40	0.11
		G-X300CrMo15																
12	AISI12	130 HB	120	260	0.04	0.15	0.06	0.32	0.07	0.35	0.07	0.39						

When using grooving inserts for side turning, the cutting depth is dependent upon the width of insert, the material and the rigidity of the workpiece.

Depth of cut recommendation:

- Max Ap (d.o.c.) is equal to 70% of insert width
- Min Ap (d.o.c.) is equal to the corner radius

MACHINING CONDITIONS

MILLING

**Minimize your
machining down time**



ADKT 1505 PDTR

AOMT 123608 PETR

Material Group	Lamina Gr. N°	Material Examples	Hardness	DOC [mm]		Feed [mm/z]		Vc [m/min]		Suggested Starting Parameters					
				min	max	min	max	min	max	DOC	Feed	Vc			
P Non Alloyed Low Alloyed High Alloyed	1	C35, Ck45, 1020, 1045, 1060, 28Mn6	125 HB	0.50	14.00	0.18	0.32	190	250	4.00	0.23	250			
			190 HB						220			220			
			250 HB						200			200			
	2	42CrMo4, St50, Ck60, 4140, 4340, 100Cr6	180 HB	0.50	14.00	0.15	0.25	150	200	4.00	0.20	200			
			230 HB						180			180			
			280 HB				0.22	130	150			0.18	150		
			350 HB						140				140		
	3	X40CrMoV5, H13, M42, D3, S6-5-2, 12Ni19	220 HB	0.50	10.00	0.12	0.22	90	130	3.00	0.18		130		
			280 HB						120				120		
320 HB			0.18				60	100	0.16			100			
350 HB								80				80			
4	304, 316, X5CrNi18-9	180 HB	0.50	14.00	0.15	0.25	190	220		4.00	0.20	220			
		240 HB						160				190			
M Duplex	5	X2CrNiN23-4, S31500	290 HB	0.50	10.00	0.12	0.18	70	100	3.00	0.16	100			
			310 HB						90			90			
Ferritic & Martensitic	6	410, X6Cr17, 17-4PH, 430	200 HB	0.50	14.00	0.15	0.25	150	190	4.00	0.20	190			
			42 HRC						90			130	3.00	0.16	130
K Grey Malleable & Nodular	7	GG20, GG40, EN-GJL-250, N030B	150 HB	0.50	14.00	0.18	0.32	150	200	4.00	0.23	200			
			200 HB						180			180			
			250 HB						160			160			
	8	GGG40, GGG70, 50005	150 HB	0.50	14.00	0.15	0.28	100	180	4.00	0.20	180			
			200 HB						150			150			
			250 HB						130			130			
S Fe, Ni & Co based	9	Incoloy 800	0.50	10.00	0.12	0.18	25	32	3.00	0.16	32				
		Inconel 700						30			30				
		Stellite 21						30			30				
Ti based	10	TiAl6V4	0.50	10.00	0.12	0.20	30	40	3.00	0.18	40				
		T40						40			55	0.16	55		
H Steel Chilled Cast Iron White Cast Iron	11	X100 CrMo13, 440C, G-X260NiCr42	45 HRC	0.50	1.50	0.10	0.18	40	60	2.00	0.14	60			
			50 HRC						3.00			55	1.50	0.13	55
			55 HRC						1.20			50	1.00	0.12	50
			400 HB												
			55 HRC						1.50			30	40	1.00	0.12
NF Aluminium	12	AlSi12	130 HB	0.50	14.00	0.18	0.32	200	280	4.00	0.25	280			

Material Group	Lamina Gr. N°	Material Examples	Hardness	DOC [mm]		Feed [mm/z]		Vc [m/min]		Suggested Starting Parameters					
				min	max	min	max	min	max	DOC	Feed	Vc			
P Non Alloyed Low Alloyed High Alloyed	1	C35, Ck45, 1020, 1045, 1060, 28Mn6	125 HB	0.50	11.00	0.13	0.22	190	330	2.00	0.15	250			
			190 HB						300			220			
			250 HB						250			200			
	2	42CrMo4, St50, Ck60, 4140, 4340, 100Cr6	180 HB	0.50	11.00	0.11	0.18	150	240	4.00	0.13	200			
			230 HB						210			180			
			280 HB				0.15	130	190			2.00	0.12	150	
			350 HB						170					140	
	3	X40CrMoV5, H13, M42, D3, S6-5-2, 12Ni19	220 HB	0.50	7.90	0.08	0.15	90	150	3.00	0.12			130	
			280 HB						130					120	
320 HB			0.13				60	110	1.50			0.10	100		
350 HB								90					80		
4	304, 316, X5CrNi18-9	180 HB	0.50	11.00	0.11	0.18	190	250		4.00	0.13		220		
		240 HB						160					210		
M Duplex	5	X2CrNiN23-4, S31500	290 HB	0.50	7.90	0.08	0.13	70	130	3.00	0.10	100			
			310 HB						120			90			
Ferritic & Martensitic	6	410, X6Cr17, 17-4PH, 430	200 HB	0.50	11.00	0.11	0.18	150	210	4.00	0.13	190			
			42 HRC						90			150	3.00	0.16	130
K Grey Malleable & Nodular	7	GG20, GG40, EN-GJL-250, N030B	150 HB	0.50	11.00	0.13	0.22	150	240	4.00	0.15	200			
			200 HB						220			180			
			250 HB						190			160			
	8	GGG40, GGG70, 50005	150 HB	0.50	11.00	0.11	0.20	100	200	4.00	0.13	180			
			200 HB						180			150			
			250 HB						150			130			
S Fe, Ni & Co based	9	Incoloy 800	0.50	7.90	0.08	0.13	25	45	3.00	0.10	32				
		Inconel 700						45			30				
		Stellite 21						45			30				
Ti based	10	TiAl6V4	0.50	7.90	0.08	0.14	30	55	3.00	0.12	40				
		T40						40			65	0.10	55		
H Steel Chilled Cast Iron White Cast Iron	11	X100 CrMo13, 440C, G-X260NiCr42	45 HRC	0.50	3.90	0.07	0.13	40	80	2.00	0.09	60			
			50 HRC						2.40			70	0.80	55	
			55 HRC						1.20			60	1.00	0.12	50
			400 HB												
			55 HRC						1.20			30	60	0.50	0.08
NF Aluminium	12	AlSi12	130 HB	0.50	11.00	0.13	0.22	200	400	4.00	0.16	280			

APKT 060204 PDTR

XPKT 0602-HF

Material Group	Lamina Gr. N°	Material Examples	Hardness	DOC [mm]		Feed [mm/z]		Vc [m/min]		Suggested Starting Parameters									
				min	max	min	max	min	max	DOC	Feed	Vc							
P	Non Alloyed	C35, Ck45, 1020, 1045, 1060, 28Mn6	125 HB	0.30	5.50	0.04	0.13	190	330	1.30	0.07	250							
			190 HB						300			220							
			250 HB						250			200							
	Low Alloyed	2	42CrMo4, St50, Ck60, 4140, 4340, 100Cr6	180 HB	0.30	5.50	0.03	0.10	150	240	1.30	0.06	200						
				230 HB						210			180						
				280 HB				0.09	130	190			0.05	150					
				350 HB						170				140					
	High Alloyed	3	X40CrMoV5, H13, M42, D3, S6-5-2, 12Ni19	220 HB	0.30	3.90	0.03	0.09	90	150	1.00	0.05		130					
				280 HB						130				120					
				320 HB				0.07	60	110			0.60	100					
				350 HB						90				80					
	M	Austenitic	4	304, 316, X5CrNi18-9	0.30	5.50	0.03	0.10	190	250	1.30	0.06		220					
240 HB				0.09				160	210	190									
Duplex		5	X2CrNiN23-4, S31500	290 HB	0.30	3.90	0.03	0.07	70	130	1.00	0.05	100						
				310 HB						120			90						
Ferritic & Martensitic		6	410, X6Cr17, 17-4PH, 430	200 HB	0.30	5.50	0.03	0.10	150	210	1.30	0.06	190						
				42 HRC				0.08	90	150			100	0.05	130				
K	Grey	7	GG20, GG40, EN-GJL-250, N030B	0.30	5.50	0.04	0.13	150	240	1.30	0.07	200							
			200 HB						220			180							
			250 HB						190			160							
	Malleable & Nodular	8	GGG40, GGG70, 50005	150 HB	0.30	5.50	0.03	0.11	100	200	1.30	0.06	180						
200 HB				180						150									
S	Fe, Ni & Co based	9	Incoloy 800	0.30	3.90	0.03	0.07	25	45	1.00	0.05	32							
			240 HB						45			30							
			Inconel 700						250 HB			45	30						
	Ti based	10	TiAl6V4	0.30	3.90	0.03	0.08	30	55	1.00	0.05	40							
			-				0.07	40	65			55							
			T40				-	-	-			-							
H	Steel	11	X100 CrMo13, 440C, G-X260NiCr42	0.30	2.00	0.02	0.06	40	80	0.70	0.04	60							
			45 HRC						0.40			70	55						
			50 HRC						0.30			0.20	0.70	40	0.60	0.50	50		
			55 HRC															60	50
			400 HB															80	50
Chilled Cast Iron	White Cast Iron	11	Ni-Hard 2	0.30	1.60	0.07	0.07	80	0.50	0.30	0.04	50							
			55 HRC						0.60			30	60	0.30	40				
NF	Aluminium	12	AISI12	0.30	5.50	0.04	0.13	200	400	1.30	0.08	280							

Material Group	Lamina Gr. N°	Material Examples	Hardness	DOC [mm]		Feed [mm/z]		Vc [m/min]		Suggested Starting Parameters									
				min	max	min	max	min	max	DOC	Feed	Vc							
P	Non Alloyed	C35, Ck45, 1020, 1045, 1060, 28Mn6	125 HB	0.20	0.50	0.20	1.40	190	330	0.50	1.00	250							
			190 HB						300			220							
			250 HB						250			200							
	Low Alloyed	2	42CrMo4, St50, Ck60, 4140, 4340, 100Cr6	180 HB	0.20	0.50	0.20	1.30	150	240	0.40	0.80	200						
				230 HB						210			180						
				280 HB					0.09	130			190	0.70	150				
				350 HB									170		140				
	High Alloyed	3	X40CrMoV5, H13, M42, D3, S6-5-2, 12Ni19	220 HB	0.20	0.40	0.20	1.10	90	150	0.40	0.70	130						
				280 HB						130			120						
				320 HB					0.07	60			110	0.60	100				
				350 HB									90		80				
	M	Austenitic	4	304, 316, X5CrNi18-9	0.20	0.40	0.20	0.70	190	0.40	0.50	220							
240 HB				160					210			190							
Duplex		5	X2CrNiN23-4, S31500	290 HB	0.20	0.40	0.20	0.50	70	0.40	0.35	100							
				310 HB					120			90							
Ferritic & Martensitic		6	410, X6Cr17, 17-4PH, 430	200 HB	0.20	0.40	0.20	0.50	150	0.40	0.40	190							
				42 HRC					90			150	0.30	130					
K	Grey	7	GG20, GG40, EN-GJL-250, N030B	0.20	0.50	0.20	1.40	150	240	0.50	1.00	200							
			200 HB						220			180							
			250 HB						190			160							
	Malleable & Nodular	8	GGG40, GGG70, 50005	150 HB	0.20	0.50	0.20	1.20	100	200	0.50	0.90	180						
200 HB				180						150									
S	Fe, Ni & Co based	9	Incoloy 800	0.20	0.40	0.20	0.50	25	45	0.30	0.30	32							
			240 HB						45			30							
			Inconel 700						250 HB			45	30						
	Ti based	10	TiAl6V4	0.20	0.40	0.20	0.40	30	55	0.30	0.30	40							
			-					40	65			55							
			T40					-	-			-	-						
H	Steel	11	X100 CrMo13, 440C, G-X260NiCr42	0.20	0.40	0.20	0.70	40	80	0.40	0.40	60							
			45 HRC						0.60			70	55						
			50 HRC						0.30			0.20	0.50	80	0.20	0.30	50		
			55 HRC															60	50
			400 HB															80	50
Chilled Cast Iron	White Cast Iron	11	Ni-Hard 2	0.20	1.60	0.07	0.07	80	0.50	0.30	0.04	50							
			55 HRC						0.60			30	60	0.30	40				
NF	Aluminium	12	AISI12	0.20	5.50	0.04	0.13	200	400	1.30	0.08	280							

APKT 100304 PDTR

APKT 100308 PDTR
APMT 0903 PDTR

Material Group	Lamina Gr. N°	Material Examples	Hardness	DOC [mm]		Feed [mm/z]		Vc [m/min]		Suggested Starting Parameters					
				min	max	min	max	min	max	DOC	Feed	Vc			
P	Non Alloyed	C35, Ck45, 1020, 1045, 1060, 28Mn6	125 HB	0.50	9.00	0.11	0.20	190	330	2.00	0.14	250			
			190 HB									220			
			250 HB									200			
	Low Alloyed	2	42CrMo4, St50, Ck60, 4140, 4340, 100Cr6	180 HB	0.50	9.00	0.09	0.16	150	240	2.00	0.12	200		
				230 HB									180		
				280 HB				0.14	130				190	0.11	150
				350 HB											140
	High Alloyed	3	X40CrMoV5, H13, M42, D3, S6-5-2, 12Ni19	220 HB	0.50	6.40	0.07	0.14	90	150	1.50	0.11	130		
				280 HB									120		
				320 HB				0.11	60				110	0.10	100
				350 HB											80
	M	Austenitic	4	304, 316, X5CrNi18-9	0.50	9.00	0.09	0.16	190	250	2.00	0.12	220		
240 HB				190											
Duplex		5	X2CrNiN23-4, S31500	290 HB	0.50	6.40	0.07	0.11	70	130	1.50	0.10	100		
				310 HB									90		
Ferritic & Martensitic		6	410, X6Cr17, 17-4PH, 430	200 HB	0.50	9.00	0.09	0.16	150	210	2.00	0.12	190		
				42 HRC									130		
K	Grey	7	GG20, GG40, EN-GJL-250, N030B	0.50	9.00	0.11	0.20	150	240	2.00	0.14	200			
			200 HB									180			
			250 HB									160			
	Malleable & Nodular	8	GGG40, GGG70, 50005	150 HB	0.50	9.00	0.09	0.17	100	200	2.00	0.12	180		
200 HB				150											
S	Fe, Ni & Co based	9	Incoloy 800	0.50	6.40	0.07	0.11	25	45	1.50	0.10	32			
			240 HB									30			
			250 HB									30			
	Ti based	10	TiAl6V4	0.50	6.40	0.07	0.12	30	55	1.50	0.11	0.10	40		
			-										55		
			T40										55		
H	Steel	11	X100 CrMo13, 440C, G-X260NiCr42	0.50	3.20	0.06	0.11	40	80	1.00	0.09	60			
			50 HRC									55			
			55 HRC									50			
			1.90									50			
			1.00									50			
			2.60									50			
Chilled Cast Iron	Ni-Hard 2	400 HB	2.60	0.11	80	0.80	0.09	50	50	0.09	0.07	40			
												55 HRC	40		
White Cast Iron	G-X300CrMo15	55 HRC	1.00	0.09	30	60	0.50	0.07	40	0.07	0.07	40			
												40			
NF	Aluminium	12	AISI12	130 HB	0.50	9.00	0.11	0.20	200	400	2.00	0.16	280		

Material Group	Lamina Gr. N°	Material Examples	Hardness	DOC [mm]		Feed [mm/z]		Vc [m/min]		Suggested Starting Parameters					
				min	max	min	max	min	max	DOC	Feed	Vc			
P	Non Alloyed	C35, Ck45, 1020, 1045, 1060, 28Mn6	125 HB	0.50	9.00	0.13	0.26	190	330	2.00	0.17	250			
			190 HB									220			
			250 HB									200			
	Low Alloyed	2	42CrMo4, St50, Ck60, 4140, 4340, 100Cr6	180 HB	0.50	9.00	0.11	0.21	150	240	2.00	0.15	200		
				230 HB									180		
				280 HB				0.18	130				190	0.13	150
				350 HB											140
	High Alloyed	3	X40CrMoV5, H13, M42, D3, S6-5-2, 12Ni19	220 HB	0.50	6.40	0.08	0.18	90	150	1.50	0.13	130		
				280 HB									120		
				320 HB				0.15	60				110	0.12	100
				350 HB											80
	M	Austenitic	4	304, 316, X5CrNi18-9	0.50	9.00	0.11	0.21	190	250	2.00	0.15	220		
240 HB				190											
Duplex		5	X2CrNiN23-4, S31500	290 HB	0.50	6.40	0.08	0.15	70	130	1.50	0.12	100		
				310 HB									90		
Ferritic & Martensitic		6	410, X6Cr17, 17-4PH, 430	200 HB	0.50	9.00	0.11	0.21	150	210	2.00	0.15	190		
				42 HRC									130		
K	Grey	7	GG20, GG40, EN-GJL-250, N030B	0.50	9.00	0.13	0.26	150	240	2.00	0.17	200			
			200 HB									180			
			250 HB									160			
	Malleable & Nodular	8	GGG40, GGG70, 50005	150 HB	0.50	9.00	0.11	0.23	100	200	2.00	0.15	180		
200 HB				150											
S	Fe, Ni & Co based	9	Incoloy 800	0.50	6.40	0.08	0.15	25	45	1.50	0.12	32			
			240 HB									30			
			250 HB									30			
	Ti based	10	TiAl6V4	0.50	6.40	0.08	0.16	30	55	1.50	0.13	0.10	40		
			-										55		
			T40										55		
H	Steel	11	X100 CrMo13, 440C, G-X260NiCr42	0.50	3.20	0.07	0.15	40	80	1.00	0.10	60			
			50 HRC									55			
			55 HRC									50			
			1.90									50			
			1.00									50			
			2.60									50			
Chilled Cast Iron	Ni-Hard 2	400 HB	2.60	0.15	80	0.80	0.10	50	50	0.09	0.07	40			
												55 HRC	40		
White Cast Iron	G-X300CrMo15	55 HRC	1.00	0.11	30	60	0.50	0.09	40	0.07	0.07	40			
												40			
NF	Aluminium	12	AISI12	130 HB	0.50	9.00	0.13	0.26	200	400	2.00	0.18	280		

APKT 100312 PDTR

APKT 100316 PDTR

Material Group	Lamina Gr. N°	Material Examples	Hardness	DOC [mm]		Feed [mm/z]		Vc [m/min]		Suggested Starting Parameters						
				min	max	min	max	min	max	DOC	Feed	Vc				
P Non Alloyed Low Alloyed High Alloyed	1	C35, Ck45, 1020, 1045, 1060, 28Mn6	125 HB	0.50	9.00	0.13	0.28	190	330	2.00	0.20	250				
			190 HB						300			220				
			250 HB						250			200				
	2	42CrMo4, St50, Ck60, 4140, 4340, 100Cr6	180 HB	0.50	9.00	0.10	0.22	150	240	2.00	0.18	200				
			230 HB						210			180				
			280 HB				0.19	130	190		0.16	150				
			350 HB						170			140				
	3	X40CrMoV5, H13, M42, D3, S6-5-2, 12Ni19	220 HB	0.50	6.40	0.08	0.19	90	150	1.50	0.16	130				
			280 HB						130			120				
320 HB			0.16				60	110	0.14		100					
350 HB								90			80					
Austenitic	4	304, 316, X5CrNi18-9	180 HB	0.50	9.00	0.10	0.22	190	2.00	0.18	220					
			240 HB			0.08	0.19	160			210	190				
M Duplex	5	X2CrNiN23-4, S31500	290 HB	0.50	6.40	0.08	0.16	70	1.50	0.14	100					
			310 HB								120	90				
Ferritic & Martensitic	6	410, X6Cr17, 17-4PH, 430	200 HB	0.50	9.00	0.10	0.22	150	2.00	0.18	190					
			42 HRC				0.18	90			150	1.50	0.14	130		
K Grey	7	GG20, GG40, EN-GJL-250, N030B	150 HB	0.50	9.00	0.13	0.28	150	240	2.00	0.20	200				
			200 HB						220			180				
			250 HB						190			160				
Malleable & Nodular	8	GGG40, GGG70, 50005	150 HB	0.50	9.00	0.10	0.25	100	200	2.00	0.18	180				
			200 HB						180			150				
			250 HB						150			130				
S Fe, Ni & Co based	9	Incoloy 800	240 HB	0.50	6.40	0.08	0.16	25	45	1.50	0.14	32				
		Inconel 700	250 HB						45			30				
		Stellite 21	350 HB						45			30				
Ti based	10	TiAl6V4	-	0.50	6.40	0.08	0.18	30	1.50	0.16	40					
		T40	-				0.16	40			65	0.14	55			
H Steel Chilled Cast Iron White Cast Iron	11	X100 CrMo13, 440C, G-X260NiCr42	45 HRC	0.50	3.20	0.07	0.16	40	80	1.00	0.12	60				
			50 HRC						1.90			0.14	70	0.80	0.11	55
			55 HRC						1.00			0.12	60	0.50	0.10	50
			400 HB						2.60			0.16	80	0.80	0.12	50
			55 HRC						1.00			0.12	30	60	0.50	0.10
NF Aluminium	12	AlSi12	130 HB	0.50	9.00	0.13	0.28	200	400	2.00	0.22	280				

Material Group	Lamina Gr. N°	Material Examples	Hardness	DOC [mm]		Feed [mm/z]		Vc [m/min]		Suggested Starting Parameters						
				min	max	min	max	min	max	DOC	Feed	Vc				
P Non Alloyed Low Alloyed High Alloyed	1	C35, Ck45, 1020, 1045, 1060, 28Mn6	125 HB	0.50	9.00	0.13	0.28	190	330	2.00	0.20	250				
			190 HB						300			220				
			250 HB						250			200				
	2	42CrMo4, St50, Ck60, 4140, 4340, 100Cr6	180 HB	0.50	9.00	0.10	0.22	150	240	2.00	0.18	200				
			230 HB						210			180				
			280 HB				0.19	130	190		0.16	150				
			350 HB						170			140				
	3	X40CrMoV5, H13, M42, D3, S6-5-2, 12Ni19	220 HB	0.50	6.40	0.08	0.19	90	150	1.50	0.16	130				
			280 HB						130			120				
320 HB			0.16				60	110	0.14		100					
350 HB								90			80					
Austenitic	4	304, 316, X5CrNi18-9	180 HB	0.50	9.00	0.10	0.22	190	2.00	0.18	220					
			240 HB			0.08	0.19	160			210	190				
M Duplex	5	X2CrNiN23-4, S31500	290 HB	0.50	6.40	0.08	0.16	70	1.50	0.14	100					
			310 HB								120	90				
Ferritic & Martensitic	6	410, X6Cr17, 17-4PH, 430	200 HB	0.50	9.00	0.10	0.22	150	2.00	0.18	190					
			42 HRC				0.18	90			150	1.50	0.14	130		
K Grey	7	GG20, GG40, EN-GJL-250, N030B	150 HB	0.50	9.00	0.13	0.28	150	240	2.00	0.20	200				
			200 HB						220			180				
			250 HB						190			160				
Malleable & Nodular	8	GGG40, GGG70, 50005	150 HB	0.50	9.00	0.10	0.25	100	200	2.00	0.18	180				
			200 HB						180			150				
			250 HB						150			130				
S Fe, Ni & Co based	9	Incoloy 800	240 HB	0.50	6.40	0.08	0.16	25	45	1.50	0.14	32				
		Inconel 700	250 HB						45			30				
		Stellite 21	350 HB						45			30				
Ti based	10	TiAl6V4	-	0.50	6.40	0.08	0.18	30	1.50	0.16	40					
		T40	-				0.16	40			65	0.14	55			
H Steel Chilled Cast Iron White Cast Iron	11	X100 CrMo13, 440C, G-X260NiCr42	45 HRC	0.50	3.20	0.07	0.16	40	80	1.00	0.12	60				
			50 HRC						1.90			0.14	70	0.80	0.11	55
			55 HRC						1.00			0.12	60	0.50	0.10	50
			400 HB						2.60			0.16	80	0.80	0.12	50
			55 HRC						1.00			0.12	30	60	0.50	0.10
NF Aluminium	12	AlSi12	130 HB	0.50	9.00	0.13	0.28	200	400	2.00	0.22	280				

APKT 100332 PDTR

APKT 100340 PDTR

Material Group	Lamina Gr. N°	Material Examples	Hardness	DOC [mm]		Feed [mm/z]		Vc [m/min]		Suggested Starting Parameters					
				min	max	min	max	min	max	DOC	Feed	Vc			
P	Non Alloyed	C35, Ck45, 1020, 1045, 1060, 28Mn6	125 HB	0.50	9.00	0.13	0.32	190	330	1.00	0.23	250			
			190 HB						300			220			
			250 HB						250			200			
	Low Alloyed	2	42CrMo4, St50, Ck60, 4140, 4340, 100Cr6	180 HB	0.50	9.00	0.10	0.25	150	240	1.00	0.20	200		
				230 HB						210			180		
				280 HB				130	190	0.18			150		
				350 HB					170				140		
	High Alloyed	3	X40CrMoV5, H13, M42, D3, S6-5-2, 12Ni19	220 HB	0.50	6.40	0.08	0.22	90	150	1.00	0.18	130		
				280 HB						130			120		
				320 HB				60	110	0.16			100		
				350 HB					90				80		
	M	Austenitic	4	304, 316, X5CrNi18-9	0.50	9.00	0.10	0.25	190	250	1.00	0.20	220		
0.08				0.22			160	210	190						
Duplex		5	X2CrNiN23-4, S31500	290 HB	0.50	6.40	0.08	0.18	70	130	1.00	0.16	100		
				310 HB						120			90		
Ferritic & Martensitic		6	410, X6Cr17, 17-4PH, 430	200 HB	0.50	9.00	0.10	0.25	150	210	1.00	0.20	190		
				42 HRC				6.40	0.20	90			150	0.16	130
K	Grey	7	GG20, GG40, EN-GJL-250, N030B	0.50	9.00	0.13	0.32	150	240	1.00	0.23	200			
			200 HB						220			180			
			250 HB						190			160			
	Malleable & Nodular	8	GGG40, GGG70, 50005	0.50	9.00	0.10	0.28	100	200	1.00	0.20	180			
200 HB	180	150													
250 HB	150	130													
S	Fe, Ni & Co based	9	Incoloy 800	0.50	6.40	0.08	0.18	25	45	1.00	0.16	32			
			240 HB						45			30			
			Inconel 700						250 HB			45	30		
	Ti based	10	TiAl6V4	0.50	6.40	0.08	0.20	30	55	1.00	0.18	40			
			T40				0.18	40	65			0.16	55		
	H	Steel	11	X100 CrMo13, 440C, G-X260NiCr42	0.40	1.00	0.07	0.18	40	80	0.70	0.14	60		
1.90				0.16				70		0.13			55		
55 HRC				0.14				60		0.12			50		
Ni-Hard 2				400 HB				2.60		0.18			80	0.14	50
G-X300CrMo15				55 HRC				1.00		0.14			30	60	0.12
NF	Aluminium	12	AISI12	130 HB	0.50	9.00	0.13	0.32	200	400	1.00	0.25	280		

Material Group	Lamina Gr. N°	Material Examples	Hardness	DOC [mm]		Feed [mm/z]		Vc [m/min]		Suggested Starting Parameters					
				min	max	min	max	min	max	DOC	Feed	Vc			
P	Non Alloyed	C35, Ck45, 1020, 1045, 1060, 28Mn6	125 HB	0.50	9.00	0.13	0.32	190	330	1.00	0.25	250			
			190 HB						300			220			
			250 HB						250			200			
	Low Alloyed	2	42CrMo4, St50, Ck60, 4140, 4340, 100Cr6	180 HB	0.50	9.00	0.10	0.25	150	240	1.00	0.22	200		
				230 HB						210			180		
				280 HB				130	190	0.20			150		
				350 HB					170				140		
	High Alloyed	3	X40CrMoV5, H13, M42, D3, S6-5-2, 12Ni19	220 HB	0.50	6.40	0.08	0.22	90	150	1.00	0.20	130		
				280 HB						130			120		
				320 HB				60	110	0.18			100		
				350 HB					90				80		
	M	Austenitic	4	304, 316, X5CrNi18-9	0.50	9.00	0.10	0.25	190	250	1.00	0.22	220		
0.08				0.22			160	210	190						
Duplex		5	X2CrNiN23-4, S31500	290 HB	0.50	6.40	0.08	0.18	70	130	1.00	0.18	100		
				310 HB						120			90		
Ferritic & Martensitic		6	410, X6Cr17, 17-4PH, 430	200 HB	0.50	9.00	0.10	0.25	150	210	1.00	0.22	190		
				42 HRC				6.40	0.20	90			150	0.18	130
K	Grey	7	GG20, GG40, EN-GJL-250, N030B	0.50	9.00	0.13	0.32	150	240	1.00	0.25	200			
			200 HB						220			180			
			250 HB						190			160			
	Malleable & Nodular	8	GGG40, GGG70, 50005	0.50	9.00	0.10	0.28	100	200	1.00	0.22	180			
200 HB	180	150													
250 HB	150	130													
S	Fe, Ni & Co based	9	Incoloy 800	0.50	6.40	0.08	0.18	25	45	1.00	0.18	32			
			240 HB						45			30			
			Inconel 700						250 HB			45	30		
	Ti based	10	TiAl6V4	0.50	6.40	0.08	0.20	30	55	1.00	0.20	40			
			T40				0.18	40	65			0.18	55		
	H	Steel	11	X100 CrMo13, 440C, G-X260NiCr42	0.40	1.00	0.07	0.18	40	80	0.70	0.15	60		
1.90				0.16				70		0.14			55		
55 HRC				0.14				60		0.13			50		
Ni-Hard 2				400 HB				2.60		0.18			80	0.15	50
G-X300CrMo15				55 HRC				1.00		0.14			30	60	0.13
NF	Aluminium	12	AISI12	130 HB	0.50	9.00	0.13	0.32	200	400	1.00	0.28	280		

ANKX 170608 PNTR*
 APKT 1604 PDTR
 APKT 160408 PDTR

APKT 160416 PDTR

Material Group	Lamina Gr. N°	Material Examples	Hardness	DOC [mm]		Feed [mm/z]		Vc [m/min]		Suggested Starting Parameters					
				min	max	min	max	min	max	DOC	Feed	Vc			
P Non Alloyed Low Alloyed High Alloyed	1	C35, Ck45, 1020, 1045, 1060, 28Mn6	125 HB	0.50	15.00	0.18	0.32	190	330	4.00	0.23	250			
			190 HB						300			220			
			250 HB						250			200			
	2	42CrMo4, St50, Ck60, 4140, 4340, 100Cr6	180 HB	0.50	15.00	0.15	0.25	150	240	4.00	0.20	200			
			230 HB						210			180			
			280 HB				0.22	130	190			0.18	150		
			350 HB						170				140		
	3	X40CrMoV5, H13, M42, D3, S6-5-2, 12Ni19	220 HB	0.50	10.70	0.12	0.22	90	150	3.00	0.18		130		
			280 HB						130				120		
			320 HB				0.18	60	110			0.16	100		
			350 HB						90				80		
	4	304, 316, X5CrNi18-9	180 HB	0.50	15.00	0.15	0.25	190	250	4.00	0.20		220		
240 HB			160						190						
M Duplex	5	X2CrNiN23-4, S31500	290 HB	0.50	10.70	0.12	0.18	70	130	3.00	0.16	100			
			310 HB						120			90			
Ferritic & Martensitic	6	410, X6Cr17, 17-4PH, 430	200 HB	0.50	15.00	0.15	0.25	150	210	4.00	0.20	190			
			42 HRC						90			150	3.00	0.16	130
K Grey	7	GG20, GG40, EN-GJL-250, N030B	150 HB	0.50	15.00	0.18	0.32	150	240	4.00	0.23	200			
			200 HB						220			180			
			250 HB						190			160			
K Malleable & Nodular	8	GGG40, GGG70, 50005	150 HB	0.50	15.00	0.15	0.28	100	200	4.00	0.20	180			
			200 HB						180			150			
			250 HB						150			130			
S Fe, Ni & Co based	9	Incoloy 800	0.50	10.70	0.12	0.18	25	45	3.00	0.16	32				
		Inconel 700						45			30				
		Stellite 21						45			30				
S Ti based	10	TiAl6V4	0.50	10.70	0.12	0.20	30	55	3.00	0.18	40				
		T40						40			55				
H Steel	11	X100 CrMo13, 440C, G-X260NiCr42	45 HRC	0.50	5.40	0.10	0.18	40	80	2.00	0.14	60			
			50 HRC						3.20			70	1.50	0.13	55
			55 HRC						1.60			60	1.00	0.12	50
			400 HB						4.30			80	1.50	0.14	50
			55 HRC						1.60			30	60	1.00	0.12
Chilled Cast Iron	11	Ni-Hard 2	400 HB	0.50	4.30	0.18	80	1.50	1.50	0.14	50				
			400 HB					1.50			0.14	50			
White Cast Iron	11	G-X300CrMo15	55 HRC	0.50	1.60	0.14	30	60	1.00	0.12	40				
			55 HRC					1.60			0.14	30	60	1.30	0.12
NF Aluminium	12	AISI12	130 HB	0.50	15.00	0.18	0.32	200	400	4.00	0.25	280			

Material Group	Lamina Gr. N°	Material Examples	Hardness	DOC [mm]		Feed [mm/z]		Vc [m/min]		Suggested Starting Parameters					
				min	max	min	max	min	max	DOC	Feed	Vc			
P Non Alloyed Low Alloyed High Alloyed	1	C35, Ck45, 1020, 1045, 1060, 28Mn6	125 HB	0.50	15.00	0.18	0.32	190	330	4.00	0.23	250			
			190 HB						300			220			
			250 HB						250			200			
	2	42CrMo4, St50, Ck60, 4140, 4340, 100Cr6	180 HB	0.50	15.00	0.15	0.25	150	240	4.00	0.20	200			
			230 HB						210			180			
			280 HB				0.22	130	190			0.18	150		
			350 HB						170				140		
	3	X40CrMoV5, H13, M42, D3, S6-5-2, 12Ni19	220 HB	0.50	10.70	0.12	0.22	90	150	3.00	0.18		130		
			280 HB						130				120		
			320 HB				0.18	60	110			0.16	100		
			350 HB						90				80		
	4	304, 316, X5CrNi18-9	180 HB	0.50	15.00	0.15	0.25	190	250	4.00	0.20		220		
240 HB			160						190						
M Duplex	5	X2CrNiN23-4, S31500	290 HB	0.50	10.70	0.12	0.18	70	130	3.00	0.16	100			
			310 HB						120			90			
Ferritic & Martensitic	6	410, X6Cr17, 17-4PH, 430	200 HB	0.50	15.00	0.15	0.25	150	210	4.00	0.20	190			
			42 HRC						90			150	3.00	0.16	130
K Grey	7	GG20, GG40, EN-GJL-250, N030B	150 HB	0.50	15.00	0.18	0.32	150	240	4.00	0.23	200			
			200 HB						220			180			
			250 HB						190			160			
K Malleable & Nodular	8	GGG40, GGG70, 50005	150 HB	0.50	15.00	0.15	0.28	100	200	4.00	0.20	180			
			200 HB						180			150			
			250 HB						150			130			
S Fe, Ni & Co based	9	Incoloy 800	0.50	10.70	0.12	0.18	25	45	3.00	0.16	32				
		Inconel 700						45			30				
		Stellite 21						45			30				
S Ti based	10	TiAl6V4	0.50	10.70	0.12	0.20	30	55	3.00	0.18	40				
		T40						40			55				
H Steel	11	X100 CrMo13, 440C, G-X260NiCr42	45 HRC	0.50	5.40	0.10	0.18	40	80	2.00	0.14	60			
			50 HRC						3.20			70	1.50	0.13	55
			55 HRC						1.60			60	1.00	0.12	50
			400 HB						4.30			80	1.50	0.14	50
			55 HRC						1.60			30	60	1.00	0.12
Chilled Cast Iron	11	Ni-Hard 2	400 HB	0.50	4.30	0.18	80	1.50	1.50	0.14	50				
			400 HB					1.50			0.14	50			
White Cast Iron	11	G-X300CrMo15	55 HRC	0.50	1.60	0.14	30	60	1.00	0.12	40				
			55 HRC					1.60			0.14	30	60	1.30	0.12
NF Aluminium	12	AISI12	130 HB	0.50	15.00	0.18	0.32	200	400	4.00	0.25	280			

*For slot milling : Reduce the feed rate to 60%
 Max feed rate after chip thickness compensation = 0.8mm/tooth
 Not recommended for Ramping Down operation

APKT 160424 PDTR

APKT 160432 PDTR

Material Group	Lamina Gr. N°	Material Examples	Hardness	DOC [mm]		Feed [mm/z]		Vc [m/min]		Suggested Starting Parameters				
				min	max	min	max	min	max	DOC	Feed	Vc		
P	Non Alloyed	C35, Ck45, 1020, 1045, 1060, 28Mn6	125 HB	0.50	15.00	0.18	0.32	190	330	5.00	0.23	250		
			190 HB									220		
			250 HB									200		
	Low Alloyed	2	42CrMo4, St50, Ck60, 4140, 4340, 100Cr6	180 HB	0.50	15.00	0.15	0.25	150	240	5.00	0.20	200	
				230 HB									180	
				280 HB			0.22	130	190				150	
				350 HB										140
	High Alloyed	3	X40CrMoV5, H13, M42, D3, S6-5-2, 12Ni19	220 HB	0.50	10.70	0.12	0.22	90	150	3.80	0.18	130	
				280 HB									120	
				320 HB			0.18	60	110				100	
				350 HB										80
	M	Austenitic	4	304, 316, X5CrNi18-9	0.50	15.00	0.15	0.25	190	250	5.00	0.20	220	
240 HB				0.12			0.22	160	210	190				
Duplex		5	X2CrNiN23-4, S31500	290 HB	0.50	10.70	0.12	0.18	70	130	3.80	0.16	100	
				310 HB									120	90
Ferritic & Martensitic		6	410, X6Cr17, 17-4PH, 430	200 HB	0.50	15.00	0.15	0.25	150	210	5.00	0.20	190	
				42 HRC				0.20	90	150			3.80	0.16
K	Grey	7	GG20, GG40, EN-GJL-250, N030B	0.50	15.00	0.18	0.32	150	240	5.00	0.23	200		
			200 HB									180		
			250 HB									160		
	Malleable & Nodular	8	GGG40, GGG70, 50005	150 HB	0.50	15.00	0.15	0.28	100	200	5.00	0.20	180	
200 HB				150										
S	Fe, Ni & Co based	9	Incoloy 800	0.50	10.70	0.12	0.18	25	45	3.80	0.16	32		
			240 HB						30					
			Inconel 700						250 HB			45	30	
	Ti based	10	TiAl6V4	-	0.50	10.70	0.12	0.20	30	55	3.80	0.18	40	
				45				30						
				Stellite 21				350 HB	45	30				
H	Steel	11	X100 CrMo13, 440C, G-X260NiCr42	0.50	5.40	0.10	0.18	40	80	2.50	0.14	60		
			50 HRC		3.20		0.16		70			1.90	0.13	55
			55 HRC		1.60		0.14		60			1.30	0.12	50
	Chilled Cast Iron	Ni-Hard 2	400 HB	0.50	4.30	0.18	80	1.90	0.14	50				
			55 HRC	0.50	1.60	0.14	30	60	1.30	0.12	40			
	White Cast Iron	G-X300CrMo15	55 HRC	0.50	1.60	0.14	30	60	1.30	0.12	40			
55 HRC			0.50	1.60	0.14	30	60	1.30	0.12	40				
NF	Aluminium	12	AISI12	130 HB	0.50	15.00	0.18	0.32	200	400	5.00	0.25	280	

Material Group	Lamina Gr. N°	Material Examples	Hardness	DOC [mm]		Feed [mm/z]		Vc [m/min]		Suggested Starting Parameters				
				min	max	min	max	min	max	DOC	Feed	Vc		
P	Non Alloyed	C35, Ck45, 1020, 1045, 1060, 28Mn6	125 HB	0.50	15.00	0.18	0.32	190	330	5.00	0.23	250		
			190 HB									220		
			250 HB									200		
	Low Alloyed	2	42CrMo4, St50, Ck60, 4140, 4340, 100Cr6	180 HB	0.50	15.00	0.15	0.25	150	240	5.00	0.20	200	
				230 HB									180	
				280 HB			0.22	130	190				150	
				350 HB										140
	High Alloyed	3	X40CrMoV5, H13, M42, D3, S6-5-2, 12Ni19	220 HB	0.50	10.70	0.12	0.22	90	150	3.80	0.18	130	
				280 HB									120	
				320 HB			0.18	60	110				100	
				350 HB										80
	M	Austenitic	4	304, 316, X5CrNi18-9	0.50	15.00	0.15	0.25	190	250	5.00	0.20	220	
240 HB				0.12			0.22	160	210	190				
Duplex		5	X2CrNiN23-4, S31500	290 HB	0.50	10.70	0.12	0.18	70	130	3.80	0.16	100	
				310 HB									120	90
Ferritic & Martensitic		6	410, X6Cr17, 17-4PH, 430	200 HB	0.50	15.00	0.15	0.25	150	210	5.00	0.20	190	
				42 HRC				0.20	90	150			3.80	0.16
K	Grey	7	GG20, GG40, EN-GJL-250, N030B	0.50	15.00	0.18	0.32	150	240	5.00	0.23	200		
			200 HB									180		
			250 HB									160		
	Malleable & Nodular	8	GGG40, GGG70, 50005	150 HB	0.50	15.00	0.15	0.28	100	200	5.00	0.20	180	
200 HB				150										
S	Fe, Ni & Co based	9	Incoloy 800	0.50	10.70	0.12	0.18	25	45	3.80	0.16	32		
			240 HB						30					
			Inconel 700						250 HB			45	30	
	Ti based	10	TiAl6V4	-	0.50	10.70	0.12	0.20	30	55	3.80	0.18	40	
				45				30						
				Stellite 21				350 HB	45	30				
H	Steel	11	X100 CrMo13, 440C, G-X260NiCr42	0.50	5.40	0.10	0.18	40	80	2.50	0.14	60		
			50 HRC		3.20		0.16		70			1.90	0.13	55
			55 HRC		1.60		0.14		60			1.30	0.12	50
	Chilled Cast Iron	Ni-Hard 2	400 HB	0.50	4.30	0.18	80	1.90	0.14	50				
			55 HRC	0.50	1.60	0.14	30	60	1.30	0.12	40			
	White Cast Iron	G-X300CrMo15	55 HRC	0.50	1.60	0.14	30	60	1.30	0.12	40			
55 HRC			0.50	1.60	0.14	30	60	1.30	0.12	40				
NF	Aluminium	12	AISI12	130 HB	0.50	15.00	0.18	0.32	200	400	5.00	0.25	280	

APKT 1705 PETR

XPKW 0602-HF

Material Group	Lamina Gr. N°	Material Examples	Hardness	DOC [mm]		Feed [mm/z]		Vc [m/min]		Suggested Starting Parameters			
				min	max	min	max	min	max	DOC	Feed	Vc	
P Non Alloyed Low Alloyed High Alloyed	1	C35, Ck45, 1020, 1045, 1060, 28Mn6	125 HB	0.50	15.00	0.18	0.40	190	330	4.00	0.28	250	
			190 HB						300			220	
			250 HB						250			200	
	2	42CrMo4, St50, Ck60, 4140, 4340, 100Cr6	180 HB	0.50	15.00	0.15	0.31	150	240	4.00	0.24	200	
			230 HB						210			180	
			280 HB			0.27	130	190	0.22		150		
			350 HB					170			140		
	3	X40CrMoV5, H13, M42, D3, S6-5-2, 12Ni19	220 HB	0.50	10.70	0.12	0.27	90	150	3.00	0.22	130	
			280 HB						130			120	
320 HB			0.22				60	110	0.19		100		
350 HB								90			80		
M Austenitic Duplex Ferritic & Martensitic	4	304, 316, X5CrNi18-9	180 HB	0.50	15.00	0.15	0.31	190	4.00	0.24	220		
			240 HB			0.12	0.27	160			210	190	
	5	X2CrNiN23-4, S31500	290 HB	0.50	10.70	0.12	0.22	70	130	3.00	0.19	100	
310 HB	120	90											
6	410, X6Cr17, 17-4PH, 430	200 HB	0.50	15.00	0.15	0.31	150	210	4.00	0.24	190		
		42 HRc		10.70		0.25	90	150			3.00	0.19	130
K Grey Malleable & Nodular	7	GG20, GG40, EN-GJL-250, N030B	150 HB	0.50	15.00	0.18	0.40	150	240	4.00	0.28	200	
			200 HB						220			180	
			250 HB						190			160	
	8	GGG40, GGG70, 50005	150 HB	0.50	15.00	0.15	0.35	100	200	4.00	0.24	180	
200 HB			180						150				
250 HB			150						130				
S Fe, Ni & Co based Ti based	9	Incoloy 800	0.50	10.70	0.12	0.22	25	45	3.00	0.19	32		
		Inconel 700						45			30		
		Stellite 21						45			30		
10	TiAl6V4	0.50	10.70	0.12	0.25	30	55	3.00	0.22	0.19	40		
	T40				0.22	40	65				55		
H Steel Chilled Cast Iron White Cast Iron	11	X100 CrMo13, 440C, G-X260NiCr42	45 HRc	0.50	5.40	0.10	0.22	40	80	2.00	0.17	60	
			50 HRc		3.20		0.20		70			1.50	55
			55 HRc		1.60		0.17		60			1.00	50
			400 HB		4.30		0.22		80			1.50	50
			55 HRc		1.60		0.17		30			60	1.00
NF Aluminium	12	AISI12	130 HB	0.50	15.00	0.18	0.40	200	400	4.00	0.30	280	

Material Group	Lamina Gr. N°	Material Examples	Hardness	DOC [mm]		Feed [mm/z]		Vc [m/min]		Suggested Starting Parameters				
				min	max	min	max	min	max	DOC	Feed	Vc		
P Non Alloyed Low Alloyed High Alloyed	1	C35, Ck45, 1020, 1045, 1060, 28Mn6	125 HB	0.20	0.50	0.20	1.40	190	330	0.50	1.00	250		
			190 HB						300			220		
			250 HB						250			200		
	2	42CrMo4, St50, Ck60, 4140, 4340, 100Cr6	180 HB	0.20	0.50	0.20	1.30	150	240	0.40	0.80	200		
			230 HB						210			180		
			280 HB					130	190		0.40	0.70	150	
			350 HB						170				140	
	3	X40CrMoV5, H13, M42, D3, S6-5-2, 12Ni19	220 HB	0.20	0.40	0.20	1.10	90	150	0.40	0.70	130		
			280 HB						130			120		
320 HB			60					110	0.40		0.60	100		
350 HB								90				80		
Ferritic & Martensitic	6	410, X6Cr17, 17-4PH, 430	200 HB	0.20	0.40	0.20	0.50	150	0.40	0.40	190			
42 HRc	0.60	90	150				130							
K Grey Malleable & Nodular	7	GG20, GG40, EN-GJL-250, N030B	150 HB	0.20	0.50	0.20	1.40	150	240	0.50	1.00	200		
			200 HB						220			180		
			250 HB						190			160		
8	GGG40, GGG70, 50005	150 HB	0.20	0.50	0.20	1.20	100	200	0.50	0.90	180			
		200 HB						180			150			
		250 HB						150			130			
H Steel Chilled Cast Iron White Cast Iron	11	X100 CrMo13, 440C, G-X260NiCr42	45 HRc	0.20	0.40	0.20	0.80	40	80	0.40	0.50	60		
			50 HRc				0.70		70			0.30	40	55
			55 HRc				0.50		60			0.30	50	
			400 HB				0.20		0.30			0.20	0.50	80
G-X300CrMo15	55 HRc	0.20	0.30	0.20	0.50	30	60	0.30	0.30	40				

APMT 1135 PDTR

APMT 1604 PDTR
APMT 160408 PDTR

Material Group	Lamina Gr. N°	Material Examples	Hardness	DOC [mm]		Feed [mm/z]		Vc [m/min]		Suggested Starting Parameters					
				min	max	min	max	min	max	DOC	Feed	Vc			
P	Non Alloyed	C35, Ck45, 1020, 1045, 1060, 28Mn6	125 HB	0.50	10.00	0.13	0.22	190	330	2.00	0.15	250			
			190 HB									220			
			250 HB									200			
	Low Alloyed	2	42CrMo4, St50, Ck60, 4140, 4340, 100Cr6	180 HB	0.50	10.00	0.10	0.17	150	240	2.00	0.13	200		
				230 HB									180		
				280 HB				0.15	130				190	0.12	150
				350 HB											140
	High Alloyed	3	X40CrMoV5, H13, M42, D3, S6-5-2, 12Ni19	220 HB	0.50	7.20	0.08	0.15	90	150	1.50	0.12	130		
				280 HB									120		
				320 HB				0.13	60				110	0.10	100
				350 HB											80
	M	Austenitic	4	304, 316, X5CrNi18-9	0.50	10.00	0.10	0.17	190	250	2.00	0.13	220		
240 HB				0.08			0.15	160	210	190					
Duplex		5	X2CrNiN23-4, S31500	290 HB	0.50	7.20	0.08	0.13	70	130	1.50	0.10	100		
				310 HB						120			90		
Ferritic & Martensitic		6	410, X6Cr17, 17-4PH, 430	200 HB	0.50	10.00	0.10	0.17	150	210	2.00	0.13	190		
				42 HRC						150			150	130	
K	Grey	7	GG20, GG40, EN-GJL-250, N030B	0.50	10.00	0.13	0.22	150	240	2.00	0.15	200			
			200 HB						180						
			250 HB						160						
	Malleable & Nodular	8	GGG40, GGG70, 50005	150 HB	0.50	10.00	0.10	0.20	100	200	2.00	0.13	180		
				200 HB						150					
				250 HB						130					
S	Fe, Ni & Co based	9	Incoloy 800	0.50	7.20	0.08	0.13	25	45	1.50	0.10	32			
			240 HB						30						
			Inconel 700						250 HB			45	30		
	Ti based	10	TiAl6V4, T40	-	0.50	7.20	0.08	0.14	30	55	1.50	0.12	40		
				-				0.13	40	65			0.10	55	
				-											
H	Steel	11	X100 CrMo13, 440C, G-X260NiCr42	0.50	3.60	0.07	0.13	40	80	1.00	0.09	60			
			50 HRC		2.10		0.11		70	0.80	0.08	55			
			55 HRC		1.10		0.10		60	0.50	0.08	50			
	Chilled Cast Iron	Ni-Hard 2	400 HB	2.90	0.13	80	0.80	0.09	50						
			55 HRC	1.10	0.10	30	60	0.50	0.08	40					
	White Cast Iron	G-X300CrMo15	55 HRC												
NF Aluminium	12	AISI12	130 HB	0.50	10.00	0.13	0.22	200	400	2.00	0.16	280			

Material Group	Lamina Gr. N°	Material Examples	Hardness	DOC [mm]		Feed [mm/z]		Vc [m/min]		Suggested Starting Parameters					
				min	max	min	max	min	max	DOC	Feed	Vc			
P	Non Alloyed	C35, Ck45, 1020, 1045, 1060, 28Mn6	125 HB	0.50	15.00	0.16	0.30	190	330	4.00	0.21	250			
			190 HB									220			
			250 HB									200			
	Low Alloyed	2	42CrMo4, St50, Ck60, 4140, 4340, 100Cr6	180 HB	0.50	15.00	0.14	0.23	150	240	4.00	0.18	200		
				230 HB									180		
				280 HB				0.20	130				190	0.16	150
				350 HB											140
	High Alloyed	3	X40CrMoV5, H13, M42, D3, S6-5-2, 12Ni19	220 HB	0.50	10.70	0.11	0.20	90	150	3.00	0.16	130		
				280 HB									120		
				320 HB				0.17	60				110	0.14	100
				350 HB											80
	M	Austenitic	4	304, 316, X5CrNi18-9	0.50	15.00	0.14	0.23	190	250	4.00	0.18	220		
240 HB				0.11			0.20	160	210	190					
Duplex		5	X2CrNiN23-4, S31500	290 HB	0.50	10.70	0.11	0.17	70	130	3.00	0.14	100		
				310 HB						120			90		
Ferritic & Martensitic		6	410, X6Cr17, 17-4PH, 430	200 HB	0.50	15.00	0.14	0.23	150	210	4.00	0.18	190		
				42 HRC						150			150	130	
K	Grey	7	GG20, GG40, EN-GJL-250, N030B	0.50	15.00	0.16	0.30	150	240	4.00	0.21	200			
			200 HB						180						
			250 HB						160						
	Malleable & Nodular	8	GGG40, GGG70, 50005	150 HB	0.50	15.00	0.14	0.26	100	200	4.00	0.18	180		
				200 HB						150					
				250 HB						130					
S	Fe, Ni & Co based	9	Incoloy 800	0.50	10.70	0.11	0.17	25	45	3.00	0.14	32			
			240 HB						30						
			Inconel 700						250 HB			45	30		
	Ti based	10	TiAl6V4, T40	-	0.50	10.70	0.11	0.19	30	55	3.00	0.16	40		
				-				0.17	40	65			0.14	55	
				-											
H	Steel	11	X100 CrMo13, 440C, G-X260NiCr42	0.50	5.40	0.09	0.17	40	80	2.00	0.13	60			
			50 HRC		3.20		0.15		70	1.50	0.12	55			
			55 HRC		1.60		0.13		60	1.00	0.11	50			
	Chilled Cast Iron	Ni-Hard 2	400 HB	4.30	0.17	80	1.50	0.13	50						
			55 HRC	1.60	0.13	30	60	1.00	0.11	40					
	White Cast Iron	G-X300CrMo15	55 HRC												
NF Aluminium	12	AISI12	130 HB	0.50	15.00	0.16	0.30	200	400	4.00	0.22	280			

HNKX 0604-45

LDMT 1504 PDSR

Material Group	Lamina Gr. N°	Material Examples	Hardness	DOC [mm]		Feed [mm/z]		Vc [m/min]		Suggested Starting Parameters			
				min	max	min	max	min	max	DOC	Feed	Vc	
P	Non Alloyed	C35, Ck45, 1020, 1045, 1060, 28Mn6	125 HB	0.50	3.50	0.16	0.34	190	330	2.50	0.30	250	
			190 HB						300			220	
			250 HB						250			200	
	Low Alloyed	2	42CrMo4, St50, Ck60, 4140, 4340, 100Cr6	180 HB	0.50	3.50	0.14	0.28	150	2.50	0.26	200	
				230 HB					210			180	
				280 HB				130	190			0.24	150
				350 HB					170				140
	High Alloyed	3	X40CrMoV5, H13, M42, D3, S6-5-2, 12Ni19	220 HB	0.50	3.50	0.11	0.28	90	2.50	0.26	130	
				280 HB					130			120	
				320 HB				60	110			0.22	100
				350 HB					90				80
	M	Austenitic	4	304, 316, X5CrNi18-9	0.50	3.50	0.14	0.30	190	2.50	0.26	220	
0.11				160			210		190				
Duplex		5	X2CrNiN23-4, S31500	290 HB	0.50	3.00	0.11	0.25	70	1.70	0.22	100	
				310 HB					120			90	
Ferritic & Martensitic		6	410, X6Cr17, 17-4PH, 430	200 HB	0.50	3.50	0.14	0.30	150	2.00	0.26	190	
				42 HRC					90			150	130
K	Grey	7	GG20, GG40, EN-GJL-250, N030B	0.50	3.50	0.17	0.34	150	2.00	0.30	200		
			200 HB								220	180	
			250 HB								190	160	
	Malleable & Nodular	8	GGG40, GGG70, 50005	150 HB	0.50	3.50	0.14	0.30	100	2.00	0.27	180	
200 HB				180					150				
S	Fe, Ni & Co based	9	Incoloy 800	0.50	3.00	0.11	0.20	25	1.70	0.18	32		
			240 HB					45			30		
			250 HB					45			30		
	Ti based	10	TiAl6V4	0.50	3.00	0.11	0.25	30	1.70	0.23	40		
			-					40			65	55	
			T40					-			40	65	55
H	Steel	11	X100 CrMo13, 440C, G-X260NiCr42	0.40	1.50	0.10	0.22	40	1.00	0.18	60		
			50 HRC								70	55	
			55 HRC								60	50	
	Chilled Cast Iron	Ni-Hard 2	400 HB	1.50	0.22	80	1.00	0.19	50				
			55 HRC						30	60	40		
	White Cast Iron	G-X300CrMo15	55 HRC	1.00	0.20	30	0.70	0.17	40				
55 HRC			30						60	40			
NF	Aluminium	12	AISI12	0.50	3.50	0.17	0.36	200	400	2.00	0.30	280	

Material Group	Lamina Gr. N°	Material Examples	Hardness	DOC [mm]		Feed [mm/z]		Vc [m/min]		Suggested Starting Parameters						
				min	max	min	max	min	max	DOC	Feed	Vc				
P	Non Alloyed	C35, Ck45, 1020, 1045, 1060, 28Mn6	125 HB	0.50	14.00	0.18	0.32	190	330	4.00	0.23	250				
			190 HB						300			220				
			250 HB						250			200				
	Low Alloyed	2	42CrMo4, St50, Ck60, 4140, 4340, 100Cr6	180 HB	0.50	14.00	0.15	0.25	150	2.50	0.26	200				
				230 HB					210			180				
				280 HB				130	190			0.22	150			
				350 HB					170				140			
	High Alloyed	3	X40CrMoV5, H13, M42, D3, S6-5-2, 12Ni19	220 HB	0.50	10.00	0.12	0.22	90	3.00	0.18	130				
				280 HB					130			120				
				320 HB				60	110			0.22	100			
				350 HB					90				80			
	M	Austenitic	4	304, 316, X5CrNi18-9	0.50	14.00	0.15	0.25	190	4.00	0.20	220				
0.12				0.22			160		210			190				
Duplex		5	X2CrNiN23-4, S31500	290 HB	0.50	10.00	0.12	0.18	70	3.00	0.16	100				
				310 HB					120			90				
Ferritic & Martensitic		6	410, X6Cr17, 17-4PH, 430	200 HB	0.50	14.00	0.15	0.25	150	4.00	0.20	190				
				42 HRC					90			150	130			
K	Grey	7	GG20, GG40, EN-GJL-250, N030B	0.50	14.00	0.18	0.32	150	4.00	0.23	200					
			200 HB								220	180				
			250 HB								190	160				
	Malleable & Nodular	8	GGG40, GGG70, 50005	150 HB	0.50	14.00	0.15	0.28	100	4.00	0.20	180				
200 HB				180					150							
S	Fe, Ni & Co based	9	Incoloy 800	0.50	10.00	0.12	0.18	25	3.00	0.16	32					
			240 HB					45			30					
			250 HB					45			30					
	Ti based	10	TiAl6V4	0.50	10.00	0.12	0.20	30	3.00	0.18	40					
			-					40			65	55				
			T40					-			40	65	55			
H	Steel	11	X100 CrMo13, 440C, G-X260NiCr42	0.50	5.00	0.10	0.18	40	1.00	0.14	60					
			50 HRC								3.00	0.16	70	1.50	0.13	55
			55 HRC								1.50	0.14	60	1.00	0.12	50
	Chilled Cast Iron	Ni-Hard 2	400 HB	4.00	0.18	80	1.50	0.14	30	1.50	0.14	50				
			55 HRC						1.50			0.14	30	60	1.00	0.12
	White Cast Iron	G-X300CrMo15	55 HRC	1.50	0.14	30	0.70	0.17	40							
55 HRC			30						60	40						
NF	Aluminium	12	AISI12	0.50	14.00	0.18	0.32	200	400	4.00	0.25	280				

ODMT 0504 ZZTR
OFMT 050405 TR
OFMT 05T305 TN

ODMT 060508 TN

Material Group	Lamina Gr. N°	Material Examples	Hardness	DOC [mm]		Feed [mm/z]		Vc [m/min]		Suggested Starting Parameters							
				min	max	min	max	min	max	DOC	Feed	Vc					
P Non Alloyed Low Alloyed High Alloyed	1	C35, Ck45, 1020, 1045, 1060, 28Mn6	125 HB	0.50	3.50	0.22	0.51	190	330	2.40	0.37	250					
			190 HB						300			220					
			250 HB						250			200					
	2	42CrMo4, St50, Ck60, 4140, 4340, 100Cr6	180 HB	0.50	3.50	0.18	0.40	150	240	2.40	0.32	200					
			230 HB						210			180					
			280 HB				0.35	130	190			0.29	150				
			350 HB						170				140				
	3	X40CrMoV5, H13, M42, D3, S6-5-2, 12Ni19	220 HB	0.50	2.50	0.14	0.35	90	150	1.80	0.29		130				
			280 HB						130				120				
320 HB			0.29				60	110	0.26			100					
350 HB								90				80					
4	304, 316, X5CrNi18-9	180 HB	0.50	3.50	0.18	0.35	190	250		2.40	0.29	220					
		240 HB			0.14	0.32	160	210				190					
M Duplex	5	X2CrNiN23-4, S31500	290 HB	0.50	2.50	0.14	0.29	70	130	1.80	0.26	100					
			310 HB						120			90					
Ferritic & Martensitic	6	410, X6Cr17, 17-4PH, 430	200 HB	0.50	3.50	0.18	0.35	150	210	2.40	0.29	190					
			42 HRC						2.50			0.32	90	150	1.80	0.26	130
K Grey Malleable & Nodular	7	GG20, GG40, EN-GJL-250, N030B	150 HB	0.50	3.50	0.22	0.51	150	240	2.40	0.37	200					
			200 HB						220			180					
			250 HB						190			160					
8	GGG40, GGG70, 50005	150 HB	0.50	3.50	0.18	0.45	100	200	2.40	0.32	180						
		200 HB						180			150						
		250 HB						150			130						
S Fe, Ni & Co based Ti based	9	Incoloy 800	0.50	2.50	0.14	0.29	25	45	1.80	0.26	32						
		Inconel 700						250 HB			45	30					
		Stellite 21						350 HB			45	30					
10	TiAl6V4	0.50	2.50	0.14	0.32	30	55	1.80	0.29	0.26	40						
	T40				0.29	40	65				55						
H Steel Chilled Cast Iron White Cast Iron	11	X100 CrMo13, 440C, G-X260NiCr42	45 HRC	0.40	1.30	0.12	0.29	40	80	1.20	0.22	60					
			50 HRC						1.00			0.26	70	0.90	0.21	55	
			55 HRC						0.80			0.22	60	0.60	0.19	50	
			Ni-Hard 2						400 HB			1.00	0.29	80	0.90	0.22	50
			G-X300CrMo15						55 HRC			0.80	0.22	30	60	0.60	0.19
NF Aluminium	12	AISI12	130 HB	0.50	3.50	0.22	0.51	200	400	2.40	0.40	280					

Material Group	Lamina Gr. N°	Material Examples	Hardness	DOC [mm]		Feed [mm/z]		Vc [m/min]		Suggested Starting Parameters							
				min	max	min	max	min	max	DOC	Feed	Vc					
P Non Alloyed Low Alloyed High Alloyed	1	C35, Ck45, 1020, 1045, 1060, 28Mn6	125 HB	0.50	4.00	0.22	0.54	190	330	2.50	0.39	250					
			190 HB						300			220					
			250 HB						250			200					
	2	42CrMo4, St50, Ck60, 4140, 4340, 100Cr6	180 HB	0.50	4.00	0.18	0.43	150	240	2.50	0.34	200					
			230 HB						210			180					
			280 HB				0.37	130	190			0.31	150				
			350 HB						170				140				
	3	X40CrMoV5, H13, M42, D3, S6-5-2, 12Ni19	220 HB	0.50	2.80	0.14	0.37	90	150	1.90	0.31		130				
			280 HB						130				120				
320 HB			0.31				60	110	0.27			100					
350 HB								90				80					
4	304, 316, X5CrNi18-9	180 HB	0.50	4.00	0.18	0.37	190	250		2.50	0.31	220					
		240 HB			0.14	0.34	160	210				190					
M Duplex	5	X2CrNiN23-4, S31500	290 HB	0.50	2.80	0.14	0.31	70	130	1.90	0.27	100					
			310 HB						120			90					
Ferritic & Martensitic	6	410, X6Cr17, 17-4PH, 430	200 HB	0.50	4.00	0.18	0.37	150	210	2.50	0.31	190					
			42 HRC						2.80			0.34	90	150	1.90	0.27	130
K Grey Malleable & Nodular	7	GG20, GG40, EN-GJL-250, N030B	150 HB	0.50	4.00	0.22	0.54	150	240	2.50	0.39	200					
			200 HB						220			180					
			250 HB						190			160					
8	GGG40, GGG70, 50005	150 HB	0.50	4.00	0.18	0.48	100	200	2.50	0.34	180						
		200 HB						180			150						
		250 HB						150			130						
S Fe, Ni & Co based Ti based	9	Incoloy 800	0.50	2.80	0.14	0.31	25	45	1.90	0.27	32						
		Inconel 700						250 HB			45	30					
		Stellite 21						350 HB			45	30					
10	TiAl6V4	0.50	2.80	0.14	0.34	30	55	1.90	0.31	0.27	40						
	T40				0.31	40	65				55						
H Steel Chilled Cast Iron White Cast Iron	11	X100 CrMo13, 440C, G-X260NiCr42	45 HRC	0.40	1.40	0.12	0.31	40	80	1.30	0.24	60					
			50 HRC						1.10			0.27	70	0.90	0.22	55	
			55 HRC						0.90			0.24	60	0.60	0.20	50	
			Ni-Hard 2						400 HB			1.10	0.31	80	0.90	0.24	50
			G-X300CrMo15						55 HRC			0.90	0.24	30	60	0.60	0.20
NF Aluminium	12	AISI12	130 HB	0.50	4.00	0.22	0.54	200	400	2.50	0.43	280					

ODMW 060508 TN

OFER 070405 TN
OFMT 070405 TN

Material Group	Lamina Gr. N°	Material Examples	Hardness	DOC [mm]		Feed [mm/z]		Vc [m/min]		Suggested Starting Parameters																
				min	max	min	max	min	max	DOC	Feed	Vc														
P	Non Alloyed	C35, Ck45, 1020, 1045, 1060, 28Mn6	125 HB	0.50	4.00	0.22	0.58	190	330	3.00	0.41	250														
			190 HB						300			220														
			250 HB						250			200														
	Low Alloyed	2	42CrMo4, S150, Ck60, 4140, 4340, 100Cr6	180 HB	0.50	4.00	0.18	0.45	150	240	3.00	0.36	200													
				230 HB						210			180													
				280 HB				0.40	130	190			0.32	150												
				350 HB						170				140												
	High Alloyed	3	X40CrMoV5, H13, M42, D3, S6-5-2, 12Ni19	220 HB	0.50	2.80	0.14	0.40	90	150	2.30	0.32	130													
				280 HB						130			120													
				320 HB				0.32	60	110			0.29	100												
				350 HB						90				80												
	K	Grey	GG20, GG40, EN-GJL-250, N030B	150 HB	0.50	4.00	0.22	0.58	150	240	3.00	0.41	200													
200 HB				180						160																
250 HB				190						160																
Malleable & Nodular		8	GGG40, GGG70, 50005	150 HB	0.50	4.00	0.18	0.50	100	200	3.00	0.36	180													
				200 HB						180			150													
				250 HB						150			130													
H	Steel	X100 CrMo13, 440C, G-X260NiCr42	45 HRc	0.40	1.40	0.12	0.32	40	80	1.10	0.25	60														
			50 HRc						70			55														
			55 HRc						60			50														
			Chilled Cast Iron						Ni-Hard 2			400 HB	1.10	0.32	80	0.90	0.25	50								
												White Cast Iron						G-X300CrMo15	55 HRc	0.90	0.25	30	60	0.70	0.22	40

Material Group	Lamina Gr. N°	Material Examples	Hardness	DOC [mm]		Feed [mm/z]		Vc [m/min]		Suggested Starting Parameters								
				min	max	min	max	min	max	DOC	Feed	Vc						
P	Non Alloyed	C35, Ck45, 1020, 1045, 1060, 28Mn6	125 HB	0.50	4.50	0.22	0.51	190	330	3.00	0.37	250						
			190 HB						300			220						
			250 HB						250			200						
	Low Alloyed	2	42CrMo4, S150, Ck60, 4140, 4340, 100Cr6	180 HB	0.50	4.50	0.18	0.40	150	240	3.00	0.32	200					
				230 HB						210			180					
				280 HB				0.35	130	190			0.29	150				
				350 HB						170				140				
	High Alloyed	3	X40CrMoV5, H13, M42, D3, S6-5-2, 12Ni19	220 HB	0.50	3.20	0.14	0.35	90	150	2.20	0.29	130					
				280 HB						130			120					
				320 HB				0.29	60	110			0.26	100				
				350 HB						90				80				
	Austenitic	4	304, 316, X5CrNi18-9	180 HB	0.50	4.50	0.18	0.35	190	250	3.00	0.29	220					
240 HB				160						190								
M Duplex	5	X2CrNiN23-4, S31500	290 HB	0.50	3.20	0.14	0.29	70	130	2.20	0.26	100						
			310 HB						120			90						
Ferritic & Martensitic	6	410, X6Cr17, 17-4PH, 430	200 HB	0.50	4.50	0.18	0.35	150	210	3.00	0.29	190						
			42 HRc						90			150						
K	Grey	GG20, GG40, EN-GJL-250, N030B	150 HB	0.50	4.50	0.22	0.51	150	240	3.00	0.37	200						
			200 HB						220			180						
			250 HB						190			160						
	Malleable & Nodular	8	GGG40, GGG70, 50005	150 HB	0.50	4.50	0.18	0.45	100	200	3.00	0.32	180					
				200 HB						180			150					
				250 HB						150			130					
S	9	Incoloy 800	240 HB	0.50	3.20	0.14	0.29	25	45	2.20	0.26	32						
			Inconel 700						250 HB			45	30					
			Stellite 21						350 HB			45	30					
TI based	10	TiAl6V4	-	0.50	3.20	0.14	0.32	30	55	2.20	0.29	40						
			T40						-			40	65	55				
H	Steel	X100 CrMo13, 440C, G-X260NiCr42	45 HRc	0.40	1.60	0.12	0.29	40	80	1.50	0.22	60						
			50 HRc						70			55						
			55 HRc						60			50						
			Chilled Cast Iron						Ni-Hard 2			400 HB	1.30	0.29	80	1.10	0.22	50
												White Cast Iron						G-X300CrMo15
NF Aluminium	12	AISI12	130 HB	0.50	4.50	0.22	0.51	200	400	3.00	0.40		280					

ONKX 0806-45

RDMT 0602 M0

Material Group	Lamina Gr. N°	Material Examples	Hardness	DOC [mm]		Feed [mm/z]		Vc [m/min]		Suggested Starting Parameters						
				min	max	min	max	min	max	DOC	Feed	Vc				
P	Non Alloyed	C35, Ck45, 1020, 1045, 1060, 28Mn6	125 HB	0.50	4.00	0.16	0.58	190	330	3.00	0.46	250				
			190 HB						300			220				
			250 HB						250			200				
	Low Alloyed	2	42CrMo4, St50, Ck60, 4140, 4340, 100Cr6	180 HB	0.50	4.00	0.14	0.50	150	240	3.00	0.40	200			
				230 HB						210			180			
				280 HB				0.44	130	190			0.36	150		
				350 HB						170				140		
	High Alloyed	3	X40CrMoV5, H13, M42, D3, S6-5-2, 12Ni19	220 HB	0.50	4.00	0.11	0.44	90	150	3.00	0.36	130			
				280 HB						130			120			
				320 HB				0.36	60	110			0.32	100		
				350 HB						90				80		
	M	Austenitic	4	304, 316, X5CrNi18-9	0.50	1.50	0.14	0.44	190	250	1.20	0.34	220			
0.11				0.40			160	210	190							
Duplex		5	X2CrNiN23-4, S31500	290 HB	0.50	1.50	0.11	0.36	70	130	1.20	0.30	100			
				310 HB						120			90			
Ferritic & Martensitic		6	410, X6Cr17, 17-4PH, 430	200 HB	0.50	1.50	0.14	0.44	150	210	1.20	0.34	190			
				42 HRC				0.40	90	150			0.30	130		
K	Grey	7	GG20, GG40, EN-GJL-250, N030B	0.50	4.00	0.17	0.58	150	240	4.00	0.46	200				
			200 HB						220			180				
			250 HB						190			160				
	Malleable & Nodular	8	GGG40, GGG70, 50005	150 HB	0.50	4.00	0.14	0.52	100	200	4.00	0.40	180			
200 HB				180						150						
S	Fe, Ni & Co based	9	Incoloy 800	0.50	1.50	0.11	0.36	25	45	1.20	0.30	32				
			Inconel 700						250 HB			45	30			
			Stellite 21						350 HB			45	30			
	Ti based	10	TiAl6V4	0.50	1.50	0.11	0.40	30	55	1.20	0.34	40				
			T40				0.36	40	65			0.30	55			
	H	Steel	11	X100 CrMo13, 440C, G-X260NiCr42	0.40	1.50	0.09	0.36	40	80	2.00	0.28	60			
50 HRC				0.32				70		1.00			0.26	55		
55 HRC				0.28				60		0.50			0.24	50		
Ni-Hard 2				400 HB				3.00		0.36			80	1.50	0.28	50
G-X300CrMo15				55 HRC				1.50		0.28			30	0.50	0.24	40
Chilled Cast Iron	White Cast Iron	11	Ni-Hard 2	0.40	1.50	0.09	0.36	40	80	2.00	0.28	60				
			G-X300CrMo15				55 HRC		1.50			0.28	30	0.50	0.24	40
NF	Aluminium	12	AISI12	130 HB	0.50	1.50	0.17	0.60	200	400	1.50	0.50	280			

Material Group	Lamina Gr. N°	Material Examples	Hardness	DOC [mm]		Feed [mm/z]		Vc [m/min]		Suggested Starting Parameters				
				min	max	min	max	min	max	DOC	Feed	Vc		
P	Non Alloyed	C35, Ck45, 1020, 1045, 1060, 28Mn6	125 HB	0.50	1.50	0.18	0.48	190	330	0.80	0.29	250		
			190 HB						300			220		
			250 HB						250			200		
	Low Alloyed	2	42CrMo4, St50, Ck60, 4140, 4340, 100Cr6	180 HB	0.50	1.50	0.15	0.38	150	240	0.80	0.25	200	
				230 HB						210			180	
				280 HB				0.33	130	190			0.22	150
				350 HB						170				140
	High Alloyed	3	X40CrMoV5, H13, M42, D3, S6-5-2, 12Ni19	220 HB	0.50	1.10	0.12	0.33	90	150	0.60	0.22	130	
				280 HB						130			120	
				320 HB				0.27	60	110			0.20	100
				350 HB						90				80
	M	Austenitic	4	304, 316, X5CrNi18-9	0.50	1.50	0.15	0.38	190	250	0.80	0.25	220	
0.12				0.33			160	210	190					
Duplex		5	X2CrNiN23-4, S31500	290 HB	0.50	1.20	0.12	0.27	70	130	0.60	0.20	100	
				310 HB						120			90	
Ferritic & Martensitic		6	410, X6Cr17, 17-4PH, 430	200 HB	0.50	1.50	0.15	0.38	150	210	0.80	0.25	190	
				42 HRC				0.30	90	150			0.60	0.20
K	Grey	7	GG20, GG40, EN-GJL-250, N030B	0.50	1.50	0.18	0.48	150	240	0.80	0.29	200		
			200 HB						220			180		
			250 HB						190			160		
	Malleable & Nodular	8	GGG40, GGG70, 50005	150 HB	0.50	1.50	0.15	0.42	100	200	0.80	0.25	180	
200 HB				180						150				
S	Fe, Ni & Co based	9	Incoloy 800	0.50	1.20	0.12	0.27	25	45	0.60	0.20	32		
			Inconel 700						250 HB			45	30	
			Stellite 21						350 HB			45	30	
	Ti based	10	TiAl6V4	0.50	1.20	0.12	0.30	30	55	0.60	0.22	40		
			T40				0.27	40	65			0.20	55	
	H	Steel	11	X100 CrMo13, 440C, G-X260NiCr42	0.30	0.40	0.10	0.27	40	80	0.40	0.17	60	
50 HRC				0.24				70		0.16			55	
55 HRC				0.21				60		0.15			50	
Ni-Hard 2				400 HB				0.27		80			0.18	50
G-X300CrMo15				55 HRC				0.50		0.21			30	0.15
Chilled Cast Iron	White Cast Iron	11	Ni-Hard 2	0.30	0.40	0.10	0.27	40	80	0.40	0.17	60		
			G-X300CrMo15				55 HRC		0.50			0.21	30	0.15
NF	Aluminium	12	AISI12	130 HB	0.50	1.50	0.18	0.48	200	400	1.50	0.50	280	

RDMT 0702 M0

RDMT 0803 M0

Material Group	Lamina Gr. N°	Material Examples	Hardness	DOC [mm]		Feed [mm/z]		Vc [m/min]		Suggested Starting Parameters					
				min	max	min	max	min	max	DOC	Feed	Vc			
P Non Alloyed Low Alloyed High Alloyed	1	C35, Ck45, 1020, 1045, 1060, 28Mn6	125 HB	0.50	1.80	0.18	0.54	190	330	0.80	0.32	250			
			190 HB						300			220			
			250 HB						250			200			
	2	42CrMo4, St50, Ck60, 4140, 4340, 100Cr6	180 HB	0.50	1.80	0.15	0.43	150	240	0.80	0.28	200			
			230 HB						210			180			
			280 HB				0.37	130	190			0.25	150		
			350 HB						170				140		
	3	X40CrMoV5, H13, M42, D3, S6-5-2, 12Ni19	220 HB	0.50	1.30	0.12	0.37	90	150	0.60	0.25	130			
			280 HB						130			120			
320 HB			0.31				60	110	0.22			100			
350 HB								90				80			
M Austenitic Duplex Ferritic & Martensitic	4	304, 316, X5CrNi18-9	180 HB	0.50	1.80	0.15	0.43	190	0.80	0.28	220				
			240 HB			0.12	0.37	160			210	190			
	5	X2CrNiN23-4, S31500	290 HB	0.50	1.40	0.12	0.31	70	130	0.60	0.22	100			
			310 HB						120			90			
	6	410, X6Cr17, 17-4PH, 430	200 HB	0.50	1.80	0.15	0.43	150	210	0.80	0.28	190			
			42 HRC						0.34			90	150	0.60	0.22
K Grey Malleable & Nodular	7	GG20, GG40, EN-GJL-250, N030B	150 HB	0.50	1.80	0.18	0.54	150	240	0.80	0.32	200			
			200 HB						220			180			
			250 HB						190			160			
	8	GGG40, GGG70, 50005	150 HB	0.50	1.80	0.15	0.48	100	200	0.80	0.28	180			
200 HB			180						150						
250 HB			150						130						
S Fe, Ni & Co based Ti based	9	Incoloy 800	240 HB	0.50	1.40	0.12	0.31	25	45	0.60	0.22	32			
			250 HB						45			30			
			350 HB						45			30			
	10	TiAl6V4	-	0.50	1.40	0.12	0.34	30	55	0.60	0.25	40			
			-				0.31	40	65			0.22	55		
			-				-	-	-			-	-		
H Steel Chilled Cast Iron White Cast Iron	11	X100 CrMo13, 440C, G-X260NiCr42	45 HRC	0.30	0.50	0.10	0.31	40	80	0.40	0.20	60			
			50 HRC						70			55			
			55 HRC						60			50			
			Ni-Hard 2				400 HB	0.31	30			60	0.30	0.20	50
								0.24						0.17	50
								0.24						0.17	40
NF Aluminium	12	AlSi12	130 HB	0.50	1.80	0.18	0.54	200	400	0.80	0.35	280			

Material Group	Lamina Gr. N°	Material Examples	Hardness	DOC [mm]		Feed [mm/z]		Vc [m/min]		Suggested Starting Parameters					
				min	max	min	max	min	max	DOC	Feed	Vc			
P Non Alloyed Low Alloyed High Alloyed	1	C35, Ck45, 1020, 1045, 1060, 28Mn6	125 HB	0.50	2.00	0.18	0.58	190	330	0.80	0.34	250			
			190 HB						300			220			
			250 HB						250			200			
	2	42CrMo4, St50, Ck60, 4140, 4340, 100Cr6	180 HB	0.50	2.00	0.15	0.45	150	240	0.80	0.30	200			
			230 HB						210			180			
			280 HB				0.40	130	190			0.27	150		
			350 HB						170				140		
	3	X40CrMoV5, H13, M42, D3, S6-5-2, 12Ni19	220 HB	0.50	1.40	0.12	0.40	90	150	0.60	0.27	130			
			280 HB						130			120			
320 HB			0.32				60	110	0.24			100			
350 HB								90				80			
M Austenitic Duplex Ferritic & Martensitic	4	304, 316, X5CrNi18-9	180 HB	0.50	2.00	0.15	0.45	190	0.80	0.30	220				
			240 HB			0.12	0.40	160			210	190			
	5	X2CrNiN23-4, S31500	290 HB	0.50	1.50	0.12	0.32	70	130	0.60	0.24	100			
			310 HB						120			90			
6	410, X6Cr17, 17-4PH, 430	200 HB	0.50	2.00	0.15	0.45	150	210	0.80	0.30	190				
		42 HRC						0.36			90	150	0.60	0.24	130
K Grey Malleable & Nodular	7	GG20, GG40, EN-GJL-250, N030B	150 HB	0.50	2.00	0.18	0.58	150	240	0.80	0.34	200			
			200 HB						220			180			
			250 HB						190			160			
	8	GGG40, GGG70, 50005	150 HB	0.50	2.00	0.15	0.50	100	200	0.80	0.30	180			
200 HB			180						150						
250 HB			150						130						
S Fe, Ni & Co based Ti based	9	Incoloy 800	240 HB	0.50	1.50	0.12	0.32	25	45	0.60	0.24	32			
			250 HB						45			30			
			350 HB						45			30			
	10	TiAl6V4	-	0.50	1.50	0.12	0.36	30	55	0.60	0.27	40			
			-				0.32	40	65			0.24	55		
			-				-	-	-			-	-		
H Steel Chilled Cast Iron White Cast Iron	11	X100 CrMo13, 440C, G-X260NiCr42	45 HRC	0.30	0.50	0.10	0.32	40	80	0.40	0.21	60			
			50 HRC						70			55			
			55 HRC						60			50			
			Ni-Hard 2				400 HB	0.32	30			60	0.30	0.25	50
								0.50						0.18	50
								0.60						0.21	50
NF Aluminium	12	AlSi12	130 HB	0.50	2.00	0.18	0.58	200	400	0.80	0.38	280			

MACHINING CONDITIONS | MILLING

LT 30 - LT 3000
RDMT 1003 M0
RDMT 10T3 M0
RDMX 10T3 M0

LT 3000
RDMX 1003 M0
RXMT 10T3 M0
RXMX 10T3 M0

Material Group	Lamina Gr. N°	Material Examples	Hardness	DOC [mm]		Feed [mm/z]		Vc [m/min]		Suggested Starting Parameters				
				min	max	min	max	min	max	DOC	Feed	Vc		
P	Non Alloyed	C35, Ck45, 1020, 1045, 1060, 28Mn6	125 HB	0.50	2.50	0.18	0.64	190	330	1.00	0.34	250		
			190 HB						300			220		
			250 HB						250			200		
	Low Alloyed	2	42CrMo4, St50, Ck60, 4140, 4340, 100Cr6	180 HB	0.50	2.50	0.15	0.50	150	240	1.00	0.30	200	
				230 HB						210			180	
				280 HB				0.44	130	190			0.27	150
				350 HB						170				140
	High Alloyed	3	X40CrMoV5, H13, M42, D3, S6-5-2, 12Ni19	220 HB	0.50	1.80	0.12	0.44	90	150	0.80	0.27		130
				280 HB						130				120
				320 HB				0.36	60	110			0.24	100
				350 HB						90				80
	M	Austenitic	4	304, 316, X5CrNi18-9	0.50	2.50	0.15	0.50	190	250	1.00	0.30		220
240 HB				0.12			0.44	160	210	190				
Duplex		5	X2CrNiN23-4, S31500	290 HB	0.50	2.00	0.12	0.36	70	130	0.80	0.24	100	
				310 HB						120			90	
Ferritic & Martensitic		6	410, X6Cr17, 17-4PH, 430	200 HB	0.50	2.50	0.15	0.50	150	210	1.00	0.30	190	
				42 HRC				0.40	90	150			0.80	0.24
K	Grey	7	GG20, GG40, EN-GJL-250, N030B	0.50	2.50	0.18	0.64	150	240	1.00	0.34	200		
			200 HB						220			180		
			250 HB						190			160		
	Malleable & Nodular	8	GGG40, GGG70, 50005	150 HB	0.50	2.50	0.15	0.56	100	200	1.00	0.30	180	
200 HB				180						150				
S	Fe, Ni & Co based	9	Incoloy 800	0.50	2.00	0.12	0.36	25	45	0.80	0.24	32		
			240 HB						45			30		
			Inconel 700						250 HB			45	30	
	Ti based	10	TiAl6V4	0.50	2.00	0.12	0.40	30	55	0.80	0.27	0.24	40	
			-				0.36	40	65				55	
			T40				-	-	-				-	
H	Steel	11	X100 CrMo13, 440C, G-X260NiCr42	0.30	0.60	0.10	0.36	40	80	0.50	0.21	60		
			45 HRC				0.70		70			0.40	0.19	55
			50 HRC				0.28		60			0.30	0.18	50
			55 HRC									0.36	80	0.40
			Chilled Cast Iron				Ni-Hard 2		400 HB			0.70	0.36	80
White Cast Iron	G-X300CrMo15	55 HRC	0.60	0.28	30	60	0.30	0.18	40					
NF	Aluminium	12	AISI12	130 HB	0.50	2.50	0.18	0.64	200	400	1.00	0.38	280	

MACHINING CONDITIONS | MILLING

LT 30 - LT 3000
RDMT 1204 M0
RDMT 12T3 M0

LT 3000
RDMX 1204 M0
RDMX 12T3 M0
RXMT 1204 M0
RXMX 1204 M0

Material Group	Lamina Gr. N°	Material Examples	Hardness	DOC [mm]		Feed [mm/z]		Vc [m/min]		Suggested Starting Parameters					
				min	max	min	max	min	max	DOC	Feed	Vc			
P	Non Alloyed	C35, Ck45, 1020, 1045, 1060, 28Mn6	125 HB	0.50	3.00	0.25	0.74	190	330	1.30	0.34	250			
			190 HB						300			220			
			250 HB						250			200			
	Low Alloyed	2	42CrMo4, St50, Ck60, 4140, 4340, 100Cr6	180 HB	0.50	3.00	0.21	0.57	150	240	1.30	0.30	200		
				230 HB						210			180		
				280 HB				0.51	130	190			0.27	150	
				350 HB						170				140	
	High Alloyed	3	X40CrMoV5, H13, M42, D3, S6-5-2, 12Ni19	220 HB	0.50	2.20	0.17	0.51	90	150	1.00	0.27		130	
				280 HB						130				120	
				320 HB				0.41	60	110			0.24	100	
				350 HB						90				80	
	M	Austenitic	4	304, 316, X5CrNi18-9	0.50	3.00	0.21	0.57	190	250	1.30	0.30		220	
240 HB				0.17			0.51	160	210	190					
Duplex		5	X2CrNiN23-4, S31500	290 HB	0.50	2.40	0.17	0.41	70	130	1.00	0.24	100		
				310 HB						120			90		
Ferritic & Martensitic		6	410, X6Cr17, 17-4PH, 430	200 HB	0.50	3.00	0.21	0.57	150	210	1.30	0.30	190		
				42 HRC				0.46	90	150			1.00	0.24	130
K	Grey	7	GG20, GG40, EN-GJL-250, N030B	0.50	3.00	0.25	0.74	150	240	1.30	0.34	200			
			200 HB						220			180			
			250 HB						190			160			
	Malleable & Nodular	8	GGG40, GGG70, 50005	150 HB	0.50	3.00	0.21	0.64	100	200	1.30	0.30	180		
200 HB				180						150					
S	Fe, Ni & Co based	9	Incoloy 800	0.50	2.40	0.17	0.41	25	45	1.00	0.24	32			
			240 HB						45			30			
			Inconel 700						250 HB			45	30		
	Ti based	10	TiAl6V4	0.50	2.40	0.17	0.46	30	55	0.80	0.27	0.24	40		
			-				0.41	40	65				55		
			T40				-	-	-				-		
H	Steel	11	X100 CrMo13, 440C, G-X260NiCr42	0.30	1.10	0.14	0.41	40	80	0.70	0.21	60			
			45 HRC						0.90			70	0.50	0.19	55
			50 HRC						0.80			60	0.30	0.18	50
			55 HRC										0.32	80	0.40
			Chilled Cast Iron						Ni-Hard 2			400 HB	0.90	0.41	80
White Cast Iron	G-X300CrMo15	55 HRC	0.80	0.32	30	60	0.30	0.18	40						
NF	Aluminium	12	AISI12	130 HB	0.50	3.00	0.25	0.74	200	400	1.30	0.38	280		

RDMT 1604 M0

Material Group	Lamina Gr. N°	Material Examples	Hardness	DOC [mm]		Feed [mm/z]		Vc [m/min]		Suggested Starting Parameters		
				min	max	min	max	min	max	DOC	Feed	Vc
P Non Alloyed Low Alloyed High Alloyed	1	C35, Ck45, 1020, 1045, 1060, 28Mn6	125 HB	0.50	4.00	0.25	1.00	190	330	2.00	0.34	250
			190 HB									220
			250 HB									200
	2	42CrMo4, St50, Ck60, 4140, 4340, 100Cr6	180 HB	0.50	4.00	0.21	0.78	150	240	2.00	0.30	200
			230 HB									180
			280 HB									150
			350 HB									140
	3	X40CrMoV5, H13, M42, D3, S6-5-2, 12Ni19	220 HB	0.50	2.80	0.17	0.69	90	150	1.50	0.27	130
			280 HB									120
320 HB			100									
4	304, 316, X5CrNi18-9	180 HB	0.50	4.00	0.21	0.78	190	250	2.00	0.30	220	
		240 HB									190	
		290 HB									100	
5	X2CrNiN23-4, S31500	310 HB	0.50	3.10	0.17	0.56	70	130	1.50	0.24	90	
		310 HB									90	
6	410, X6Cr17, 17-4PH, 430	200 HB	0.50	4.00	0.21	0.78	150	210	2.00	0.30	190	
		42 HRC									130	
K Grey Malleable & Nodular	7	GG20, GG40, EN-GJL-250, N030B	150 HB	0.50	4.00	0.25	1.00	150	240	2.00	0.34	200
			200 HB									180
			250 HB									160
	8	GGG40, GGG70, 50005	150 HB	0.50	4.00	0.21	0.88	100	200	2.00	0.30	180
			200 HB									150
S Fe, Ni & Co based Ti based	9	Incoloy 800	0.50	3.10	0.17	0.56	25	45	1.50	0.24	32	
		Inconel 700									30	
		Stellite 21									30	
H Steel Chilled Cast Iron White Cast Iron NF Aluminium	10	TiAl6V4	0.50	3.10	0.17	0.63	30	55	1.50	0.27	40	
		T40									55	
	11	X100 CrMo13, 440C, G-X260NiCr42	45 HRC	0.40	1.40	0.14	0.56	40	80	1.00	0.21	60
			50 HRC									55
			55 HRC									50
			55 HRC									50
	12	AlSi12	130 HB	0.50	4.00	0.25	1.00	200	400	2.00	0.38	280
			130 HB									280

LT 30 - LT 3000
RDMW 1003 M0
RDMW 10T3 M0

LT 3000
RXMW 10T3 M0

Material Group	Lamina Gr. N°	Material Examples	Hardness	DOC [mm]		Feed [mm/z]		Vc [m/min]		Suggested Starting Parameters		
				min	max	min	max	min	max	DOC	Feed	Vc
P Non Alloyed Low Alloyed High Alloyed	1	C35, Ck45, 1020, 1045, 1060, 28Mn6	125 HB	0.50	2.50	0.18	0.70	190	0.58	1.00	0.39	250
			190 HB									220
			250 HB									200
	2	42CrMo4, St50, Ck60, 4140, 4340, 100Cr6	180 HB	0.50	2.50	0.15	0.55	130	0.45	1.00	0.34	200
			230 HB									180
			280 HB									150
			350 HB									140
	3	X40CrMoV5, H13, M42, D3, S6-5-2, 12Ni19	220 HB	0.50	1.80	0.12	0.48	60	0.40	0.80	0.31	130
			280 HB									120
320 HB			100									
K Grey Malleable & Nodular	7	GG20, GG40, EN-GJL-250, N030B	150 HB	0.50	2.50	0.18	0.70	150	0.58	1.00	0.39	200
			200 HB									180
			250 HB									160
	8	GGG40, GGG70, 50005	150 HB	0.50	2.50	0.15	0.62	100	0.50	1.00	0.34	180
			200 HB									150
H Steel Chilled Cast Iron White Cast Iron	11	X100 CrMo13, 440C, G-X260NiCr42	45 HRC	0.30	0.90	0.10	0.40	30	0.32	0.50	0.24	60
			50 HRC									55
			55 HRC									50
			55 HRC									50
			55 HRC									50
11	Ni-Hard 2	400 HB	0.30	0.70	0.10	0.40	30	0.32	0.40	0.24	50	
		400 HB									50	
		400 HB									50	
11	G-X300CrMo15	55 HRC	0.30	0.60	0.10	0.31	30	0.25	0.30	0.20	40	
		55 HRC									40	

LT 30 - LT 3000
RDMW 1204 M0
RDMW 12T3 M0

LT 3000
RXMW 1204 M0

Material Group	Lamina Gr. N°	Material Examples	Hardness	DOC [mm]		Feed [mm/z]		Vc [m/min]		Suggested Starting Parameters		
				min	max	min	max	min	max	DOC	Feed	Vc
P Non Alloyed Low Alloyed High Alloyed	1	C35, Ck45, 1020, 1045, 1060, 28Mn6	125 HB	0.50	4.00	0.27	0.70	190	330	1.50	0.60	250
			190 HB									220
			250 HB									200
	2	42CrMo4, St50, Ck60, 4140, 4340, 100Cr6	180 HB	0.50	4.00	0.25	0.65	130	240	1.50	0.55	180
			230 HB									150
			280 HB									140
			350 HB									140
	3	X40CrMoV5, H13, M42, D3, S6-5-2, 12Ni19	220 HB	0.50	2.00	0.20	0.57	60	150	1.00	0.50	130
			280 HB									120
320 HB			100									
K Grey Malleable & Nodular	7	GG20, GG40, EN-GJL-250, N030B	150 HB	0.50	3.00	0.20	0.80	150	240	2.00	0.60	200
			200 HB									180
			250 HB									160
	8	GGG40, GGG70, 50005	150 HB	0.50	2.50	0.20	0.60	100	200	1.50	0.55	180
			200 HB									150
H Steel Chilled Cast Iron White Cast Iron	11	X100 CrMo13, 440C, G-X260NiCr42	45 HRC	0.30	1.00	0.18	0.38	30	0.50	0.38	0.30	60
			50 HRC									55
			55 HRC									50
			55 HRC									50
			55 HRC									50
11	Ni-Hard 2	400 HB	0.30	1.00	0.18	0.38	30	0.50	0.38	0.30	50	
		400 HB									50	
11	G-X300CrMo15	55 HRC	0.30	0.50	0.18	0.34	30	0.50	0.34	0.30	40	
		55 HRC									40	

SDKT 1204 AETN

Material Group	Lamina Gr. N°	Material Examples	Hardness	DOC [mm]		Feed [mm/z]		Vc [m/min]		Suggested Starting Parameters			
				min	max	min	max	min	max	DOC	Feed	Vc	
P Non Alloyed Low Alloyed High Alloyed	1	C35, Ck45, 1020, 1045, 1060, 28Mn6	125 HB	0.50	7.00	0.18	0.53	190	330	3.00	0.39	250	
			190 HB						300			220	
			250 HB						250			200	
	2	42CrMo4, St50, Ck60, 4140, 4340, 100Cr6	180 HB	0.50	7.00	0.15	0.41	150	240	3.00	0.34	200	
			230 HB						210			180	
			280 HB				0.36	130	190			0.31	150
			350 HB						170				140
	3	X40CrMoV5, H13, M42, D3, S6-5-2, 12Ni19	220 HB	0.50	5.00	0.12	0.36	90	150	2.30	0.31		130
			280 HB						130				120
320 HB			0.30				60	110	0.27			100	
350 HB								90				80	
4	304, 316, X5CrNi18-9	180 HB	0.50	7.00	0.15	0.36	190	250		3.00	0.31	220	
		240 HB						160				190	
M Duplex	5	X2CrNiN23-4, S31500	290 HB	0.50	5.00	0.12	0.30	70	130	2.30	0.27	100	
			310 HB						120			90	
Ferritic & Martensitic	6	410, X6Cr17, 17-4PH, 430	200 HB	0.50	7.00	0.15	0.36	150	210	3.00	0.31	190	
			42 HRc						90			150	2.30
K Grey	7	GG20, GG40, EN-GJL-250, N030B	150 HB	0.50	7.00	0.18	0.53	150	240	3.00	0.39	200	
			200 HB						220			180	
			250 HB						190			160	
Malleable & Nodular	8	GGG40, GGG70, 50005	150 HB	0.50	7.00	0.15	0.46	100	200	3.00	0.34	180	
			200 HB						180			150	
			250 HB						150			130	
S Fe, Ni & Co based	9	Incoloy 800	0.50	5.00	0.12	0.30	25	45	2.30	0.27	32		
		Inconel 700						45			30		
		Stellite 21						45			30		
Ti based	10	TiAl6V4	0.50	5.00	0.12	0.33	30	55	2.30	0.31	40		
		T40						40			55		
H Steel Chilled Cast Iron White Cast Iron	11	X100 CrMo13, 440C, G-X260NiCr42	45 HRc	0.50	2.50	0.10	0.30	40	80	1.50	0.24	60	
			50 HRc						70			55	
			55 HRc						60			50	
			400 HB						80			50	
			55 HRc						30			60	0.80
NF Aluminium	12	AISI12	130 HB	0.50	7.00	0.18	0.53	200	400	3.00	0.43	280	

SDKW 0904-HF

Material Group	Lamina Gr. N°	Material Examples	Hardness	DOC [mm]		Feed [mm/z]		Vc [m/min]		Suggested Starting Parameters			
				min	max	min	max	min	max	DOC	Feed	Vc	
P Non Alloyed Low Alloyed High Alloyed	1	C35, Ck45, 1020, 1045, 1060, 28Mn6	125 HB	0.30	1.50	0.30	1.50	190	330	1.10	1.30	250	
			190 HB									220	
			250 HB									200	
	2	42CrMo4, St50, Ck60, 4140, 4340, 100Cr6	180 HB	0.30	1.30	0.30	1.36	130	240	0.80	1.10	200	
			230 HB									180	
			280 HB									1.00	150
			350 HB										140
	3	X40CrMoV5, H13, M42, D3, S6-5-2, 12Ni19	220 HB	0.30	1.30	0.30	1.20	60	150	0.70	0.90	130	
			280 HB									120	
320 HB			1.10									100	
350 HB												80	
K Grey	7	GG20, GG40, EN-GJL-250, N030B	150 HB	0.30	1.50	0.30	2.26	150	240	1.20	1.30	200	
			200 HB									180	
			250 HB									160	
Malleable & Nodular	8	GGG40, GGG70, 50005	150 HB	0.30	1.50	0.30	1.36	100	200	1.20	1.10	180	
			200 HB									150	
			250 HB									130	
H Steel Chilled Cast Iron White Cast Iron	11	X100 CrMo13, 440C, G-X260NiCr42	45 HRc	0.30	0.60	0.30	0.90	30	80	0.60	0.60	60	
			50 HRc									70	55
			55 HRc									60	50
			400 HB									80	50
			55 HRc									60	40
Ni-Hard 2	400 HB	55 HRc	0.30	0.60	0.30	0.60	30	80	0.40	0.50	50		
											55 HRc	60	40

SDKW 1205-HF

Material Group	Lamina Gr. N°	Material Examples	Hardness	DOC [mm]		Feed [mm/z]		Vc [m/min]		Suggested Starting Parameters			
				min	max	min	max	min	max	DOC	Feed	Vc	
P Non Alloyed Low Alloyed High Alloyed	1	C35, Ck45, 1020, 1045, 1060, 28Mn6	125 HB	0.30	2.00	0.30	2.70	190	330	1.30	1.70	250	
			190 HB									220	
			250 HB									200	
	2	42CrMo4, St50, Ck60, 4140, 4340, 100Cr6	180 HB	0.30	1.60	0.30	2.50	130	240	1.00	1.50	200	
			230 HB									180	
			280 HB				1.25					170	1.40
			350 HB										
	3	X40CrMoV5, H13, M42, D3, S6-5-2, 12Ni19	220 HB	0.30	1.60	0.30	2.25	60	150	0.80	1.20	130	
			280 HB									120	
320 HB			1.10				90					1.00	100
350 HB													80
K Grey	7	GG20, GG40, EN-GJL-250, N030B	150 HB	0.30	2.00	0.30	2.70	150	240	1.60	1.70		200
			200 HB										180
			250 HB									160	
Malleable & Nodular	8	GGG40, GGG70, 50005	150 HB	0.30	2.00	0.30	2.25	100	200	1.60	1.60	180	
			200 HB									150	
			250 HB									130	
H Steel Chilled Cast Iron White Cast Iron	11	X100 CrMo13, 440C, G-X260NiCr42	45 HRc	0.30	0.80	0.30	1.25	30	80	0.70	0.80	60	
			50 HRc									70	55
			55 HRc									60	50
			400 HB									80	50
			55 HRc									60	40
Ni-Hard 2	400 HB	55 HRc	0.30	0.70	0.30	0.80	30	80	0.40	0.60	50		
											55 HRc	60	40

SDKX 0904-HF

SDKX 1205-HF

Material Group	Lamina Gr. N°	Material Examples	Hardness	DOC [mm]		Feed [mm/z]		Vc [m/min]		Suggested Starting Parameters				
				min	max	min	max	min	max	DOC	Feed	Vc		
P	Non Alloyed	C35, Ck45, 1020, 1045, 1060, 28Mn6	125 HB	0.30	1.50	0.30	1.50	190	330	1.00	1.20	250		
			190 HB						300			220		
			250 HB						250			200		
	Low Alloyed	2	42CrMo4, St50, Ck60, 4140, 4340, 100Cr6	180 HB	0.30	1.20	0.30	1.36	150	240	0.80	1.00	200	
				230 HB						210			180	
				280 HB					130	190			0.90	150
				350 HB						170				140
	High Alloyed	3	X40CrMoV5, H13, M42, D3, S6-5-2, 12Ni19	220 HB	0.30	1.20	0.30	1.20	90	150	0.70	0.80		130
				280 HB		1.10				130				120
				320 HB		1.00			60	110			0.70	100
				350 HB						90				80
	M	Austenitic	4	304, 316, X5CrNi18-9	0.30	1.30	0.30	0.76	190	0.80	0.50	220		
240 HB				160					190					
Duplex		5	X2CrNiN23-4, S31500	290 HB	0.30	1.10	0.30	0.46	70	0.70	0.30	100		
				310 HB								120	90	
Ferritic & Martensitic		6	410, X6Cr17, 17-4PH, 430	200 HB	0.30	1.20	0.30	0.52	150	0.80	0.40	190		
				42 HRC				0.46				90	150	0.70
K	Grey	7	GG20, GG40, EN-GJL-250, N030B	0.30	1.50	0.30	2.26	150	1.20	1.20	200			
			200 HB				1.50				220	180		
			250 HB				1.50				190	160		
	Malleable & Nodular	8	GGG40, GGG70, 50005	0.30	1.50	0.30	1.36	100	1.20	1.00	180			
200 HB	180	150												
250 HB	150	130												
S	Fe, Ni & Co based	9	Incoloy 800	0.30	1.40	0.30	0.60	25	0.80	0.30	45			
			240 HB								32			
			250 HB								30			
	Ti based	10	TiAl6V4	0.30	1.40	0.30	0.52	30	0.80	0.30	40			
			-					40			65	55		
			T40					1.50			40	65	55	
H	Steel	11	X100 CrMo13, 440C, G-X260NiCr42	0.30	0.60	0.30	0.90	40	0.60	0.50	60			
			45 HRC								0.70	70	55	
			50 HRC								0.60	0.40	0.40	60
	55 HRC	80	50											
	400 HB	30	60	40										
	Chilled Cast Iron	White Cast Iron	11	Ni-Hard 2	0.30	0.60	0.30	0.60	30	0.40	0.40	50		
400 HB				55 HRC								40		
NF	Aluminium	12	AISI12	0.30	1.50	0.30	0.76	200	400	1.50	0.70	280		

Material Group	Lamina Gr. N°	Material Examples	Hardness	DOC [mm]		Feed [mm/z]		Vc [m/min]		Suggested Starting Parameters				
				min	max	min	max	min	max	DOC	Feed	Vc		
P	Non Alloyed	C35, Ck45, 1020, 1045, 1060, 28Mn6	125 HB	0.30	2.00	0.30	2.70	190	330	1.20	1.70	250		
			190 HB						300			220		
			250 HB						250			200		
	Low Alloyed	2	42CrMo4, St50, Ck60, 4140, 4340, 100Cr6	180 HB	0.30	1.60	0.30	2.50	150	240	0.90	1.50	200	
				230 HB						210			180	
				280 HB				130	190	0.90			150	
				350 HB					170				140	
	High Alloyed	3	X40CrMoV5, H13, M42, D3, S6-5-2, 12Ni19	220 HB	0.30	1.60	0.30	2.25	90		150	0.70	1.20	130
				280 HB		1.30					2.00			130
				320 HB		1.10		60	1.80	0.70	110			
				350 HB					1.60		60			90
	M	Austenitic	4	304, 316, X5CrNi18-9	0.30	1.50	0.30	1.00	190		0.80	0.80	220	
240 HB				160					210				190	
Duplex		5	X2CrNiN23-4, S31500	290 HB	0.30	1.20	0.30	0.65	70	0.80	0.50	100		
				310 HB								120	90	
Ferritic & Martensitic		6	410, X6Cr17, 17-4PH, 430	200 HB	0.30	1.50	0.30	0.70	150	0.90	0.60	190		
				42 HRC				0.65				90	150	0.80
K	Grey	7	GG20, GG40, EN-GJL-250, N030B	0.30	2.00	0.30	2.70	150	1.20	1.20	200			
			200 HB								1.50	220	180	
			250 HB								1.50	190	160	
	Malleable & Nodular	8	GGG40, GGG70, 50005	0.30	2.00	0.30	2.25	100	1.20	1.00	180			
200 HB	180	150												
250 HB	150	130												
S	Fe, Ni & Co based	9	Incoloy 800	0.30	1.80	0.30	0.90	25	0.80	0.30	45			
			240 HB								32			
			250 HB								30			
	Ti based	10	TiAl6V4	0.30	1.80	0.30	0.90	30	0.80	0.30	40			
			-					40			65	55		
			T40					2.00			40	65	55	
H	Steel	11	X100 CrMo13, 440C, G-X260NiCr42	0.30	0.80	0.30	1.25	40	0.60	0.80	60			
			45 HRC								0.70	70	55	
			50 HRC								0.60	0.40	0.40	60
	55 HRC	80	50											
	400 HB	30	60	40										
	Chilled Cast Iron	White Cast Iron	11	Ni-Hard 2	0.30	0.60	0.30	0.60	30	0.40	0.40	50		
400 HB				55 HRC								40		
NF	Aluminium	12	AISI12	0.30	2.00	0.30	1.10	200	400	2.00	1.00	280		

SEKN 1203 AFTN
SEKN 1204 AFTN

SEKR 1203 AFTN
SEKR 1204 AFTN

SEKN 1504 AFTN

Material Group	Lamina Gr. N°	Material Examples	Hardness	DOC [mm]		Feed [mm/z]		Vc [m/min]		Suggested Starting Parameters					
				min	max	min	max	min	max	DOC	Feed	Vc			
P	Non Alloyed	C35, Ck45, 1020, 1045, 1060, 28Mn6	125 HB	0.50	7.00	0.18	0.46	190	330	3.00	0.34	250			
			190 HB						300			220			
			250 HB						250			200			
	Low Alloyed	2	42CrMo4, St50, Ck60, 4140, 4340, 100Cr6	180 HB	0.50	7.00	0.15	0.36	150	240	3.00	0.30	200		
				230 HB						210			180		
				280 HB				130	190	0.27			150		
				350 HB					170				140		
	High Alloyed	3	X40CrMoV5, H13, M42, D3, S6-5-2, 12Ni19	220 HB	0.50	5.00	0.12	0.32	90		150	2.30	0.27	130	
				280 HB							130			120	
				320 HB				60	110	0.24	100				
				350 HB					90		80				
	M	Austenitic	304, 316, X5CrNi18-9	180 HB	0.50	7.00	0.15	0.32	190		250	3.00	0.27	220	
240 HB				0.12			0.29	160	210		190				
Duplex		5	X2CrNiN23-4, S31500	290 HB	0.50	5.00	0.12	0.26	70	130	2.30	0.24	100		
				310 HB						120			90		
Ferritic & Martensitic		6	410, X6Cr17, 17-4PH, 430	200 HB	0.50	7.00	0.15	0.32	150	210	3.00	0.27	190		
				42 HRC						90			150	2.30	0.24
K	Grey	GG20, GG40, EN-GJL-250, N030B	150 HB	0.50	7.00	0.18	0.46	150	240	3.00	0.34	200			
			200 HB						220			180			
			250 HB						190			160			
	Malleable & Nodular	8	GGG40, GGG70, 50005	150 HB	0.50	7.00	0.15	0.41	100	200	3.00	0.30	180		
				200 HB						180			150		
				250 HB						150			130		
S	Fe, Ni & Co based	Incoloy 800 Inconel 700 Stellite 21	240 HB	0.50	5.00	0.12	0.26	25	45	2.30	0.24	32			
			250 HB						45			30			
			350 HB						45			30			
	Ti based	10	TiAl6V4 T40	-	0.50	5.00	0.12	0.29	30	55	2.30	0.27	40		
				-				0.26	40	65			2.30	0.24	55
	H	Steel Chilled Cast Iron White Cast Iron	X100 CrMo13, 440C, G-X260NiCr42 Ni-Hard 2 G-X300CrMo15	45 HRC	0.50	1.50	0.10	0.26	40	80	1.50	0.21	60		
50 HRC				70						1.10			0.19	55	
55 HRC				60						0.80			0.18	50	
400 HB				80						1.10			0.21	50	
55 HRC				30						60			0.80	0.18	40
55 HRC				30						60			0.80	0.18	40
NF Aluminium	12	AISI12	130 HB	0.50	7.00	0.18	0.46	200	400	3.00	0.37	280			

Material Group	Lamina Gr. N°	Material Examples	Hardness	DOC [mm]		Feed [mm/z]		Vc [m/min]		Suggested Starting Parameters					
				min	max	min	max	min	max	DOC	Feed	Vc			
P	Non Alloyed	C35, Ck45, 1020, 1045, 1060, 28Mn6	125 HB	0.50	9.00	0.18	0.50	190	330	4.00	0.37	250			
			190 HB						300			220			
			250 HB						250			200			
	Low Alloyed	2	42CrMo4, St50, Ck60, 4140, 4340, 100Cr6	180 HB	0.50	9.00	0.15	0.39	150	240	3.00	0.32	200		
				230 HB						210			180		
				280 HB				130	190	0.29			150		
				350 HB					170				140		
	High Alloyed	3	X40CrMoV5, H13, M42, D3, S6-5-2, 12Ni19	220 HB	0.50	6.40	0.12	0.34	90		150	3.00	0.29	130	
				280 HB							130			120	
				320 HB				60	110	0.26	100				
				350 HB					90		80				
	M	Austenitic	304, 316, X5CrNi18-9	180 HB	0.50	9.00	0.15	0.34	190		250	4.00	0.29	220	
240 HB				0.12			0.31	160	210		190				
Duplex		5	X2CrNiN23-4, S31500	290 HB	0.50	6.40	0.12	0.28	70	130	3.00	0.26	100		
				310 HB						120			90		
Ferritic & Martensitic		6	410, X6Cr17, 17-4PH, 430	200 HB	0.50	9.00	0.15	0.34	150	210	4.00	0.29	190		
				42 HRC						6.40			0.28	90	150
K	Grey	GG20, GG40, EN-GJL-250, N030B	150 HB	0.50	9.00	0.18	0.50	150	240	4.00	0.37	200			
			200 HB						220			180			
			250 HB						190			160			
	Malleable & Nodular	8	GGG40, GGG70, 50005	150 HB	0.50	9.00	0.15	0.43	100	200	4.00	0.32	180		
				200 HB						180			150		
				250 HB						150			130		
S	Fe, Ni & Co based	Incoloy 800 Inconel 700 Stellite 21	240 HB	0.50	6.40	0.12	0.28	25	45	3.00	0.26	32			
			250 HB						45			30			
			350 HB						45			30			
	Ti based	10	TiAl6V4 T40	-	0.50	6.40	0.12	0.31	30	55	3.00	0.29	40		
				-				0.28	40	65			0.26	55	
	H	Steel Chilled Cast Iron White Cast Iron	X100 CrMo13, 440C, G-X260NiCr42 Ni-Hard 2 G-X300CrMo15	45 HRC	0.50	3.20	0.10	0.28	40	80	2.00	0.22	60		
50 HRC				70						1.50			0.21	55	
55 HRC				60						1.00			0.19	50	
400 HB				80						1.50			0.22	50	
55 HRC				30						60			1.00	0.19	40
55 HRC				30						60			1.00	0.19	40
NF Aluminium	12	AISI12	130 HB	0.50	9.00	0.18	0.50	200	400	4.00	0.40	280			

SEKT 1204 AFTN
SEKT 12T3 AGSN

SNKX 1205-45

Material Group	Lamina Gr. N°	Material Examples	Hardness	DOC [mm]		Feed [mm/z]		Vc [m/min]		Suggested Starting Parameters						
				min	max	min	max	min	max	DOC	Feed	Vc				
P	Non Alloyed	C35, Ck45, 1020, 1045, 1060, 28Mn6	125 HB	0.50	6.00	0.18	0.46	190	330	3.00	0.34	250				
			190 HB									220				
			250 HB									200				
	Low Alloyed	2	42CrMo4, St50, Ck60, 4140, 4340, 100Cr6	180 HB	0.50	6.00	0.15	0.36	150	240	3.00	0.30	200			
				230 HB									180			
				280 HB				0.32	130	190		0.27	150			
				350 HB									140			
	High Alloyed	3	X40CrMoV5, H13, M42, D3, S6-5-2, 12Ni19	220 HB	0.50	5.00	0.12	0.32	90	150	2.30	0.27	130			
				280 HB									120			
				320 HB				0.26	60	110		0.24	100			
				350 HB									80			
	M	Austenitic	4	304, 316, X5CrNi18-9	0.50	6.00	0.15	0.32	190	250	3.00	0.27	220			
240 HB				0.12			0.29	160	210	190						
Duplex		5	X2CrNiN23-4, S31500	290 HB	0.50	5.00	0.12	0.26	70	130	2.30	0.24	100			
				310 HB									120	90		
Ferritic & Martensitic		6	410, X6Cr17, 17-4PH, 430	200 HB	0.50	6.00	0.15	0.32	150	210	3.00	0.27	190			
				42 HRC									5.00	0.26	90	150
K	Grey	7	GG20, GG40, EN-GJL-250, N030B	0.50	6.00	0.18	0.46	150	240	3.00	0.34	200				
			200 HB									180				
			250 HB									160				
	Malleable & Nodular	8	GGG40, GGG70, 50005	150 HB	0.50	6.00	0.15	0.41	100	200	3.00	0.30	180			
200 HB				150												
S	Fe, Ni & Co based	9	Incoloy 800	0.50	5.00	0.12	0.26	25	45	2.30	0.24	32				
			240 HB						45			30				
			Inconel 700						250 HB			45	30			
	Ti based	10	TiAl6V4	0.50	5.00	0.12	0.29	30	55	2.30	0.27	40				
			-				0.26	40	65				2.30	0.24	55	
			T40				-	-	-				-	-	-	
H	Steel	11	X100 CrMo13, 440C, G-X260NiCr42	0.50	2.50	0.10	0.26	40	80	1.50	0.21	60				
			45 HRC						2.00			0.22	80	1.30	0.18	60
			50 HRC						1.80			0.20	70	1.30	0.16	55
	Chilled Cast Iron	Ni-Hard 2	400 HB	0.50	2.00	0.26	80	1.10	0.21	50	1.00	0.18	50			
			55 HRC										1.50	0.20	60	0.80
White Cast Iron	G-X300CrMo15	55 HRC	0.50	1.50	0.20	30	60	0.80	0.18	40	1.00	0.17	40			
		55 HRC											1.00	0.20	30	60
NF	Aluminium	12	AISI12	130 HB	0.50	6.00	0.18	0.46	200	400	3.00	0.37	280			

Material Group	Lamina Gr. N°	Material Examples	Hardness	DOC [mm]		Feed [mm/z]		Vc [m/min]		Suggested Starting Parameters						
				min	max	min	max	min	max	DOC	Feed	Vc				
P	Non Alloyed	C35, Ck45, 1020, 1045, 1060, 28Mn6	125 HB	0.50	5.00	0.16	0.34	190	330	3.00	0.30	250				
			190 HB									220				
			250 HB									200				
	Low Alloyed	2	42CrMo4, St50, Ck60, 4140, 4340, 100Cr6	180 HB	0.50	5.00	0.14	0.28	150	240	3.00	0.26	200			
				230 HB									180			
				280 HB				0.26	130			190	0.24	150		
				350 HB										170	140	
	High Alloyed	3	X40CrMoV5, H13, M42, D3, S6-5-2, 12Ni19	220 HB	0.50	5.00	0.11	0.28	90	150	3.00	0.26	130			
				280 HB									120			
				320 HB				0.24	60			110	0.22	100		
				350 HB										90	80	
	M	Austenitic	4	304, 316, X5CrNi18-9	0.50	5.00	0.14	0.30	190	250	3.00	0.26	220			
240 HB				0.11			0.30	160	210	190						
Duplex		5	X2CrNiN23-4, S31500	290 HB	0.50	4.00	0.11	0.25	70	130	2.50	0.22	100			
				310 HB									120	90		
Ferritic & Martensitic		6	410, X6Cr17, 17-4PH, 430	200 HB	0.50	5.00	0.14	0.30	150	210	3.00	0.26	190			
				42 HRC									4.00	0.25	90	150
K	Grey	7	GG20, GG40, EN-GJL-250, N030B	0.50	5.00	0.17	0.34	150	240	3.00	0.30	200				
			200 HB									180				
			250 HB									160				
	Malleable & Nodular	8	GGG40, GGG70, 50005	150 HB	0.50	5.00	0.14	0.30	100	200	3.00	0.27	180			
200 HB				150												
S	Fe, Ni & Co based	9	Incoloy 800	0.50	4.00	0.11	0.20	25	45	2.50	0.18	32				
			240 HB						45			30				
			Inconel 700						250 HB			45	30			
	Ti based	10	TiAl6V4	0.50	4.00	0.11	0.25	30	55	2.50	0.23	40				
			-				0.23	40	65				2.50	0.20	55	
			T40				-	-	-				-	-	-	
H	Steel	11	X100 CrMo13, 440C, G-X260NiCr42	0.40	2.00	0.10	0.22	40	80	1.30	0.18	60				
			45 HRC						1.00			0.18	70	1.30	0.16	55
			50 HRC						1.00			0.18	60	1.00	0.15	50
	Chilled Cast Iron	Ni-Hard 2	400 HB	0.40	2.00	0.22	80	1.10	0.21	50	1.00	0.18	50			
			55 HRC										1.00	0.20	30	60
White Cast Iron	G-X300CrMo15	55 HRC	0.40	1.00	0.20	30	60	0.80	0.18	40	1.00	0.17	40			
		55 HRC											1.00	0.20	30	60
NF	Aluminium	12	AISI12	130 HB	0.50	5.00	0.17	0.36	200	400	3.00	0.30	280			

SNKX 1607-45

Material Group	Lamina Gr. N°	Material Examples	Hardness	DOC [mm]		Feed [mm/z]		Vc [m/min]		Suggested Starting Parameters				
				min	max	min	max	min	max	DOC	Feed	Vc		
P Non Alloyed Low Alloyed High Alloyed	1	C35, Ck45, 1020, 1045, 1060, 28Mn6	125 HB	0.50	6.50	0.16	0.58	190	330	4.00	0.46	250		
			190 HB									220		
			250 HB									200		
	2	42CrMo4, St50, Ck60, 4140, 4340, 100Cr6	180 HB	0.50	6.50	0.14	0.50	150	240	4.00	0.40	200		
			230 HB									180		
			280 HB				150							
	3	X40CrMoV5, H13, M42, D3, S6-5-2, 12Ni19	280 HB	0.50	6.50	0.11	0.44	90	130	3.00	0.36	130		
			320 HB									120		
			350 HB				100							
350 HB			80											
Austenitic	4	304, 316, X5CrNi18-9	180 HB	0.50	6.50	0.14	0.44	190	250	4.00	0.34	220		
			240 HB			0.11	0.40	160	210			190		
M Duplex	5	X2CrNiN23-4, S31500	290 HB	0.50	5.00	0.11	0.36	70	130	3.00	0.30	100		
			310 HB						120			90		
Ferritic & Martensitic	6	410, X6Cr17, 17-4PH, 430	200 HB	0.50	6.50	0.14	0.44	150	210	4.00	0.34	190		
			42 HRc				5.00	0.40	90			150	3.00	0.30
K Grey Malleable & Nodular	7	GG20, GG40, EN-GJL-250, N030B	150 HB	0.50	6.50	0.17	0.58	150	240	4.00	0.46	200		
			200 HB						180					
			250 HB						160					
	8	GGG40, GGG70, 50005	150 HB	0.50	6.50	0.14	0.52	100	200	4.00	0.40	180		
200 HB			150											
S Fe, Ni & Co based Ti based	9	Incoloy 800	0.50	5.00	0.11	0.36	25	45	3.00	0.30	32			
		Inconel 700						250 HB			30			
		Stellite 21						350 HB			45			
10	TiAl6V4	-	0.50	5.00	0.11	0.40	30	55	3.00	0.34	40			
	T40	-				0.36	40	65			0.30	55		
H Steel Chilled Cast Iron White Cast Iron	11	X100 CrMo13, 440C, G-X260NiCr42	45 HRc	0.40	3.00	0.09	0.36	40	80	2.00	0.28	60		
			50 HRc				0.32		70			1.50	0.26	55
			55 HRc				0.28		60			1.00	0.24	50
			400 HB				0.36		80			1.50	0.28	50
			55 HRc				1.50		0.28			30	60	1.00
NF Aluminium	12	AISI12	130 HB	0.50	6.50	0.17	0.60	200	400	4.00	0.50	280		

SPKN 1203 EDTR
SPKN 1204 EDTR

Material Group	Lamina Gr. N°	Material Examples	Hardness	DOC [mm]		Feed [mm/z]		Vc [m/min]		Suggested Starting Parameters							
				min	max	min	max	min	max	DOC	Feed	Vc					
P Non Alloyed Low Alloyed High Alloyed	1	C35, Ck45, 1020, 1045, 1060, 28Mn6	125 HB	0.50	7.00	0.18	0.43	190	330	3.00	0.30	250					
			190 HB									220					
			250 HB									200					
	2	42CrMo4, St50, Ck60, 4140, 4340, 100Cr6	180 HB	0.50	7.00	0.15	0.34	150	240	3.00	0.26	200					
			230 HB									180					
			280 HB				0.30		170			0.23	150				
			350 HB										140				
	3	X40CrMoV5, H13, M42, D3, S6-5-2, 12Ni19	220 HB	0.50	5.00	0.12	0.30	70	150	2.30	0.23	130					
			280 HB									120					
320 HB			0.24				90		0.21			100					
350 HB												80					
K Grey Malleable & Nodular	7	GG20, GG40, EN-GJL-250, N030B	150 HB	0.50	7.00	0.18	0.43	150	240	3.00	0.30	200					
			200 HB									180					
			250 HB									160					
8	GGG40, GGG70, 50005	150 HB	0.50	7.00	0.15	0.38	100	200	3.00	0.26	180						
		200 HB									150						
		250 HB									130						
H Steel Chilled Cast Iron White Cast Iron	11	X100 CrMo13, 440C, G-X260NiCr42	45 HRc	0.50	2.50	0.10	0.24	40	80	1.50	0.18	60					
			50 HRc									1.80	0.22	70	1.10	0.17	55
			55 HRc									1.50	0.19	60	0.80	0.16	50
			400 HB									2.00	0.24	80	1.10	0.18	50
			55 HRc									1.50	0.19	60	0.80	0.16	40

SPKN 1504 EDTR

Material Group	Lamina Gr. N°	Material Examples	Hardness	DOC [mm]		Feed [mm/z]		Vc [m/min]		Suggested Starting Parameters							
				min	max	min	max	min	max	DOC	Feed	Vc					
P Non Alloyed Low Alloyed High Alloyed	1	C35, Ck45, 1020, 1045, 1060, 28Mn6	125 HB	0.50	9.00	0.18	0.43	190	330	4.00	0.30	250					
			190 HB									220					
			250 HB									200					
	2	42CrMo4, St50, Ck60, 4140, 4340, 100Cr6	180 HB	0.50	9.00	0.15	0.34	130	240	4.00	0.26	200					
			230 HB									180					
			280 HB				0.30		170			0.23	150				
			350 HB										140				
	3	X40CrMoV5, H13, M42, D3, S6-5-2, 12Ni19	220 HB	0.50	6.40	0.12	0.30	60	150	3.00	0.23	130					
			280 HB									120					
320 HB			0.24				90		0.21			100					
350 HB												80					
K Grey Malleable & Nodular	7	GG20, GG40, EN-GJL-250, N030B	150 HB	0.50	9.00	0.18	0.43	150	240	4.00	0.30	200					
			200 HB									180					
			250 HB									160					
8	GGG40, GGG70, 50005	150 HB	0.50	9.00	0.15	0.38	100	200	4.00	0.26	180						
		200 HB									150						
		250 HB									130						
H Steel Chilled Cast Iron White Cast Iron	11	X100 CrMo13, 440C, G-X260NiCr42	45 HRc	0.50	3.20	0.10	0.24	30	80	2.00	0.18	60					
			50 HRc									2.30	0.22	70	1.50	0.17	55
			55 HRc									1.90	0.19	60	1.00	0.16	50
			400 HB									2.60	0.24	80	1.50	0.18	50
			55 HRc									1.90	0.19	60	1.00	0.16	40

SPKR 1203 EDTR
SPKR 1204 EDTR

SPMT 060304 TN

Material Group	Lamina Gr. N°	Material Examples	Hardness	DOC [mm]		Feed [mm/z]		Vc [m/min]		Suggested Starting Parameters			
				min	max	min	max	min	max	DOC	Feed	Vc	
P Non Alloyed Low Alloyed High Alloyed	1	C35, Ck45, 1020, 1045, 1060, 28Mn6	125 HB	0.50	7.00	0.18	0.38	190	330	3.00	0.26	250	
			190 HB						300			220	
			250 HB						250			200	
	2	42CrMo4, St50, Ck60, 4140, 4340, 100Cr6	180 HB	0.50	7.00	0.15	0.30	150	240	3.00	0.23	200	
			230 HB						210			180	
			280 HB				0.26	130	190			0.21	150
			350 HB						170				140
	3	X40CrMoV5, H13, M42, D3, S6-5-2, 12Ni19	220 HB	0.50	5.00	0.12	0.26	90	150	2.30	0.21		130
			280 HB						130				120
			320 HB	0.50			0.22	60	110			0.18	100
			350 HB						90				80
	4	304, 316, X5CrNi18-9	180 HB	0.50	7.00	0.15	0.26	190	3.00	0.21	220		
240 HB			0.12			0.24	160	210					
5	X2CrNiN23-4, S31500	290 HB	0.50	5.00	0.12	0.22	70	130	2.30	0.18	100		
		310 HB						120			90		
6	410, X6Cr17, 17-4PH, 430	200 HB	0.50	7.00	0.15	0.26	150	210	3.00	0.21	190		
		42 HRC						90			150	2.30	0.18
K Grey Malleable & Nodular	7	GG20, GG40, EN-GJL-250, N030B	150 HB	0.50	7.00	0.18	0.38	150	240	3.00	0.26	200	
			200 HB						220			180	
			250 HB						190			160	
	8	GGG40, GGG70, 50005	150 HB	0.50	7.00	0.15	0.34	100	200	3.00	0.23	180	
			200 HB						180			150	
			250 HB						150			130	
9	Incoloy 800 Inconel 700 Stellite 21	240 HB	0.50	5.00	0.12	0.22	25	45	2.30	0.18	32		
		250 HB						45			30		
		350 HB						45			30		
10	TiAl6V4 T40	-	0.50	5.00	0.12	0.24	30	55	2.30	0.21	40		
		-				0.22	40	65			0.18	55	
H Steel Chilled Cast Iron White Cast Iron	11	X100 CrMo13, 440C, G-X260NiCr42 Ni-Hard 2 G-X300CrMo15	45 HRC	0.50	2.50	0.10	0.22	40	80	1.50	0.16	60	
			50 HRC						70			55	
			55 HRC						60			50	
			400 HB						80			50	
			55 HRC						30			60	0.80
12	AlSi12	130 HB	0.50	7.00	0.18	0.38	200	400	3.00	0.29	280		

Material Group	Lamina Gr. N°	Material Examples	Hardness	DOC [mm]		Feed [mm/z]		Vc [m/min]		Suggested Starting Parameters			
				min	max	min	max	min	max	DOC	Feed	Vc	
P Non Alloyed Low Alloyed High Alloyed	1	C35, Ck45, 1020, 1045, 1060, 28Mn6	125 HB	0.30	6.00	0.06	0.12	190	330	2.40	0.10	250	
			190 HB						300			220	
			250 HB						250			200	
	2	42CrMo4, St50, Ck60, 4140, 4340, 100Cr6	180 HB	0.30	6.00	0.06	0.12	150	240	3.00	0.23	200	
			230 HB						210			180	
			280 HB			0.05	0.10	130	190			0.21	150
			350 HB						170				140
	3	X40CrMoV5, H13, M42, D3, S6-5-2, 12Ni19	220 HB	0.30	6.00	0.06	0.08	90	150	2.30	0.21		130
			280 HB						130				120
			320 HB	0.05		0.08	60	110	0.18			100	
			350 HB					90				80	
	4	304, 316, X5CrNi18-9	180 HB	0.30	6.00	0.06	0.08	190		250	2.40	0.07	220
240 HB			160							210			
5	X2CrNiN23-4, S31500	290 HB	0.30	6.00	0.05	0.08	70	130	1.80	0.07	100		
		310 HB						120			90		
6	410, X6Cr17, 17-4PH, 430	200 HB	0.30	6.00	0.05	0.08	150	210	2.40	0.07	190		
		42 HRC						90			150	1.80	0.06
K Grey Malleable & Nodular	7	GG20, GG40, EN-GJL-250, N030B	150 HB	0.30	6.00	0.05	0.14	150	240	2.40	0.10	200	
			200 HB						220			180	
			250 HB						190			160	
	8	GGG40, GGG70, 50005	150 HB	0.30	6.00	0.05	0.14	100	200	2.40	0.10	180	
			200 HB						180			150	
			250 HB						150			130	
9	Incoloy 800 Inconel 700 Stellite 21	240 HB	0.30	6.00	0.04	0.08	25	45	1.80	0.06	32		
		250 HB						45			30		
		350 HB						45			30		
10	TiAl6V4 T40	-	0.30	6.00	0.04	0.08	30	55	1.80	0.06	40		
		-					40	65			0.18	55	
H Steel Chilled Cast Iron White Cast Iron	11	X100 CrMo13, 440C, G-X260NiCr42 Ni-Hard 2 G-X300CrMo15	45 HRC	0.30	6.00	0.04	0.10	40	80	1.20	0.08	60	
			50 HRC						70			55	
			55 HRC						60			50	
			400 HB						80			50	
			55 HRC						30			60	0.80
12	AlSi12	130 HB	0.30	6.00	0.08	0.14	200	400	2.40	0.12	280		

SPMT 09T308 TN

SPMT 120408 TN

Material Group	Lamina Gr. N°	Material Examples	Hardness	DOC [mm]		Feed [mm/z]		Vc [m/min]		Suggested Starting Parameters							
				min	max	min	max	min	max	DOC	Feed	Vc					
P Non Alloyed Low Alloyed High Alloyed	1	C35, Ck45, 1020, 1045, 1060, 28Mn6	125 HB	0.50	9.00	0.07	0.17	190	330	2.40	0.15	250					
			190 HB										0.06	0.15	300	0.13	220
			250 HB														
	2	42CrMo4, St50, Ck60, 4140, 4340, 100Cr6	180 HB	0.50	9.00	0.07	0.17	150	240	2.40	0.15	200					
			230 HB										0.06	0.15	210	0.13	180
			280 HB														
			350 HB										130	170	140		
	3	X40CrMoV5, H13, M42, D3, S6-5-2, 12Ni19	220 HB	0.50	9.00	0.07	0.15	90	150	1.80	0.13	130					
			280 HB										0.05	0.13	130	0.11	120
320 HB			0.10														
350 HB													60	90	80		
M Austenitic Duplex Ferritic & Martensitic	4	304, 316, X5CrNi18-9	180 HB	0.50	9.00	0.07	0.12	190	250	2.40	0.10	220					
			240 HB										0.05	0.10	160	210	0.08
	5	X2CrNiN23-4, S31500	290 HB	0.50	9.00	0.05	0.10	70	130	1.80	0.08	100					
			310 HB										0.08	120	0.07	90	
	6	410, X6Cr17, 17-4PH, 430	200 HB	0.50	9.00	0.05	0.08	150	210	2.40	0.07	190					
			42 HRC										90	150	1.80	0.07	130
K Grey Malleable & Nodular	7	GG20, GG40, EN-GJL-250, N030B	150 HB	0.50	9.00	0.06	0.22	150	240	2.40	0.18	200					
			200 HB										0.20	190	180		
			250 HB													190	160
	8	GGG40, GGG70, 50005	150 HB	0.50	9.00	0.06	0.22	100	200	2.40	0.18	180					
200 HB			0.05										150	150			
250 HB															150	130	
S Fe, Ni & Co based Ti based	9	Incoloy 800	240 HB	0.50	9.00	0.04	0.12	25	45	1.80	0.10	32					
			250 HB										45	30			
			350 HB												45	30	
	10	TiAl6V4	-	0.50	9.00	0.04	0.12	30	55	1.80	0.10	40					
			-										40	65	55		
			-													40	65
H Steel Chilled Cast Iron White Cast Iron	11	X100 CrMo13, 440C, G-X260NiCr42	45 HRC	0.50	9.00	0.04	0.12	40	80	1.20	0.10	60					
			50 HRC										0.10	70	0.90	0.08	55
			55 HRC														
			400 HB										0.08	80	0.90	0.06	50
			55 HRC														
			NF Aluminium										12	AlSi12	130 HB	0.50	9.00

Material Group	Lamina Gr. N°	Material Examples	Hardness	DOC [mm]		Feed [mm/z]		Vc [m/min]		Suggested Starting Parameters							
				min	max	min	max	min	max	DOC	Feed	Vc					
P Non Alloyed Low Alloyed High Alloyed	1	C35, Ck45, 1020, 1045, 1060, 28Mn6	125 HB	0.50	12.00	0.10	0.22	190	330	3.20	0.17	250					
			190 HB										0.08	0.20	300	0.17	220
			250 HB														
	2	42CrMo4, St50, Ck60, 4140, 4340, 100Cr6	180 HB	0.50	12.00	0.10	0.22	150	240	3.20	0.17	200					
			230 HB										0.08	0.20	210	0.15	180
			280 HB														
			350 HB										130	170	140		
	3	X40CrMoV5, H13, M42, D3, S6-5-2, 12Ni19	220 HB	0.50	12.00	0.08	0.20	90	150	2.40	0.17	130					
			280 HB										0.07	0.18	130	0.15	120
320 HB			0.16														
350 HB													60	90	80		
M Austenitic Duplex Ferritic & Martensitic	4	304, 316, X5CrNi18-9	180 HB	0.50	12.00	0.09	0.12	190	250	3.20	0.10	220					
			240 HB										0.08	0.10	160	210	0.08
	5	X2CrNiN23-4, S31500	290 HB	0.50	12.00	0.08	0.10	70	130	2.40	0.08	100					
			310 HB										0.06	120	0.07	90	
	6	410, X6Cr17, 17-4PH, 430	200 HB	0.50	12.00	0.08	0.12	150	210	3.20	0.10	190					
			42 HRC										90	150	2.40	0.08	130
K Grey Malleable & Nodular	7	GG20, GG40, EN-GJL-250, N030B	150 HB	0.50	12.00	0.10	0.28	150	240	3.20	0.24	180					
			200 HB										0.24	190	180		
			250 HB													190	160
	8	GGG40, GGG70, 50005	150 HB	0.50	12.00	0.10	0.26	100	200	3.20	0.24	180					
200 HB			0.24										150	150			
250 HB															150	130	
S Fe, Ni & Co based Ti based	9	Incoloy 800	240 HB	0.50	12.00	0.06	0.14	25	45	2.40	0.12	32					
			250 HB										45	30			
			350 HB												45	30	
	10	TiAl6V4	-	0.50	12.00	0.06	0.14	30	55	2.40	0.12	40					
			-										40	65	55		
			-													40	65
H Steel Chilled Cast Iron White Cast Iron	11	X100 CrMo13, 440C, G-X260NiCr42	45 HRC	0.50	12.00	0.06	0.14	40	80	1.60	0.10	60					
			50 HRC										0.12	70	1.20	55	
			55 HRC														0.08
			400 HB										0.10	80	1.20	50	
			55 HRC														30
			NF Aluminium										12	AlSi12	130 HB	0.50	12.00

SPMT 12T308

SPUN 120308

Material Group	Lamina Gr. N°	Material Examples	Hardness	DOC [mm]		Feed [mm/z]		Vc [m/min]		Suggested Starting Parameters						
				min	max	min	max	min	max	DOC	Feed	Vc				
P	Non Alloyed	C35, Ck45, 1020, 1045, 1060, 28Mn6	125 HB	0.50	9.00	0.13	0.29	190	330	3.00	0.18	250				
			190 HB						300			220				
			250 HB						250			200				
	Low Alloyed	2	42CrMo4, St50, Ck60, 4140, 4340, 100Cr6	180 HB	0.50	9.00	0.10	0.22	150	240	3.00	0.16	200			
				230 HB						210			180			
				280 HB				0.20	130	190			0.14	150		
				350 HB						170				140		
	High Alloyed	3	X40CrMoV5, H13, M42, D3, S6-5-2, 12Ni19	220 HB	0.50	6.40	0.08	0.20	90	150	2.30	0.14		130		
				280 HB						130				120		
				320 HB				0.16	60	110			0.13	100		
				350 HB						90				80		
	M	Austenitic	4	304, 316, X5CrNi18-9	0.50	9.00	0.10	0.22	190	250	3.00	0.16		220		
0.08							160							210	190	
Duplex		5	X2CrNiN23-4, S31500	290 HB	0.50	6.40	0.08	0.16	70	130	2.30	0.13	100			
				310 HB						120			90			
Ferritic & Martensitic		6	410, X6Cr17, 17-4PH, 430	200 HB	0.50	9.00	0.10	0.22	150	210	3.00	0.16	190			
				42 HRc									6.40	0.18	90	150
K	Grey	7	GG20, GG40, EN-GJL-250, N030B	0.50	9.00	0.13	0.29	150	240	3.00	0.18	200				
									200 HB			220	180			
									250 HB			190	160			
	Malleable & Nodular	8	GGG40, GGG70, 50005	150 HB	0.50	9.00	0.10	0.25	100	200	3.00	0.16	180			
				200 HB						180			150			
				250 HB						150			130			
S	Fe, Ni & Co based	9	Incoloy 800	0.50	6.40	0.08	0.16	25	45	2.30	0.13	32				
			Inconel 700						45			30				
			Stellite 21						45			30				
	Ti based	10	TiAl6V4	0.50	6.40	0.08	0.18	30	55	2.30	0.14	40				
T40	0.16	40	65				0.13		55							
H	Steel	11	X100 CrMo13, 440C, G-X260NiCr42	0.50	3.20	0.07	0.16	40	80	1.50	0.11	60				
									50 HRc			1.90	70	1.10	0.10	55
									55 HRc			1.00	60	0.80	0.10	50
									400 HB			2.60	80	1.10	0.11	50
									55 HRc			1.00	30	60	0.80	0.10
Chilled Cast Iron	White Cast Iron	12	AlSi12	0.50	9.00	0.13	0.29	200	400	3.00	0.20	280				

Material Group	Lamina Gr. N°	Material Examples	Hardness	DOC [mm]		Feed [mm/z]		Vc [m/min]		Suggested Starting Parameters							
				min	max	min	max	min	max	DOC	Feed	Vc					
P	Non Alloyed	C35, Ck45, 1020, 1045, 1060, 28Mn6	125 HB	0.50	7.00	0.18	0.37	190	330	3.00	0.26	250					
			190 HB									220					
			250 HB									200					
	Low Alloyed	2	42CrMo4, St50, Ck60, 4140, 4340, 100Cr6	180 HB	0.50	7.00	0.15	0.29	150	240	3.00	0.23	200				
				230 HB									180				
				280 HB				0.25	170				150	0.21	140		
				350 HB									140				
	High Alloyed	3	X40CrMoV5, H13, M42, D3, S6-5-2, 12Ni19	220 HB	0.50	5.00	0.12	0.25	70	150	2.30	0.21	130				
				280 HB									120				
				320 HB				0.21	90				100	0.18	80		
				350 HB									80				
	K	Grey	7	GG20, GG40, EN-GJL-250, N030B	0.50	7.00	0.18	0.37	150	240	3.00	0.26	200				
200 HB													180				
250 HB													160				
Malleable & Nodular		8	GGG40, GGG70, 50005	150 HB	0.50	7.00	0.15	0.32	100	200	3.00	0.23	180				
				200 HB									150				
				250 HB									130				
H	Steel	11	X100 CrMo13, 440C, G-X260NiCr42	0.50	2.50	0.10	0.21	40	80	1.50	0.16	60					
												50 HRc	1.80	70	1.10	0.15	55
												55 HRc	1.50	60	0.80	0.14	50
												400 HB	2.00	80	1.10	0.16	50
												55 HRc	1.50	60	0.80	0.14	40
Chilled Cast Iron	White Cast Iron	11	Ni-Hard 2, G-X300CrMo15	0.50	2.00	0.10	0.21	40	80	1.10	0.16	50					
												55 HRc	1.50	60	0.80	0.14	40

TPKN 1603 PDTR

Material Group	Lamina Gr. N°	Material Examples	Hardness	DOC [mm]		Feed [mm/z]		Vc [m/min]		Suggested Starting Parameters										
				min	max	min	max	min	max	DOC	Feed	Vc								
P	Non Alloyed	C35, Ck45, 1020, 1045, 1060, 28Mn6	125 HB	0.50	12.00	0.14	0.27	190	330	3.00	0.19	250								
			190 HB									220								
			250 HB									200								
	Low Alloyed	2	42CrMo4, St50, Ck60, 4140, 4340, 100Cr6	180 HB	0.50	12.00	0.12	0.21	150	240	3.00	0.17	200							
				230 HB									180							
				280 HB									150							
				350 HB									140							
	High Alloyed	3	X40CrMoV5, H13, M42, D3, S6-5-2, 12Ni19	220 HB	0.50	8.60	0.10	0.19	70	150	2.30	0.15	130							
				280 HB									120							
320 HB				100																
K	7	GG20, GG40, EN-GJL-250, N030B	150 HB	0.50	12.00	0.14	0.27	150	240	3.00	0.19	200								
			200 HB									180								
			250 HB									160								
			Malleable & Nodular									8	GGG40, GGG70, 50005	150 HB	0.50	12.00	0.12	0.24	100	200
200 HB	150																			
250 HB	130																			
H	11	X100 CrMo13, 440C, G-X260NiCr42	45 HRc	0.50	4.30	0.08	0.15	40	80	1.50	0.12	60								
			50 HRc									70								
			55 HRc									60								
			Chilled Cast Iron									Ni-Hard 2	400 HB	3.40	0.15	0.12	80	1.10	0.12	50
													55 HRc							
			White Cast Iron									G-X300CrMo15	400 HB	2.60	0.12	0.12	60	0.80	0.10	40
55 HRc	40																			

TPKN 2204 PDTR

Material Group	Lamina Gr. N°	Material Examples	Hardness	DOC [mm]		Feed [mm/z]		Vc [m/min]		Suggested Starting Parameters										
				min	max	min	max	min	max	DOC	Feed	Vc								
P	Non Alloyed	C35, Ck45, 1020, 1045, 1060, 28Mn6	125 HB	0.50	18.00	0.16	0.27	190	330	4.00	0.19	250								
			190 HB									220								
			250 HB									200								
	Low Alloyed	2	42CrMo4, St50, Ck60, 4140, 4340, 100Cr6	180 HB	0.50	18.00	0.14	0.21	150	240	4.00	0.17	200							
				230 HB									180							
				280 HB									150							
				350 HB									140							
	High Alloyed	3	X40CrMoV5, H13, M42, D3, S6-5-2, 12Ni19	220 HB	0.50	12.90	0.11	0.19	70	150	3.00	0.15	130							
				280 HB									120							
320 HB				100																
K	7	GG20, GG40, EN-GJL-250, N030B	150 HB	0.50	18.00	0.16	0.27	150	240	4.00	0.19	200								
			200 HB									180								
			250 HB									160								
			Malleable & Nodular									8	GGG40, GGG70, 50005	150 HB	0.50	18.00	0.14	0.24	100	200
200 HB	150																			
250 HB	130																			
H	11	X100 CrMo13, 440C, G-X260NiCr42	45 HRc	0.50	6.40	0.09	0.15	40	80	2.00	0.12	60								
			50 HRc									70								
			55 HRc									60								
			Chilled Cast Iron									Ni-Hard 2	400 HB	5.10	0.15	0.12	80	1.50	0.12	50
													55 HRc							
			White Cast Iron									G-X300CrMo15	400 HB	3.90	0.12	0.12	60	1.00	0.10	40
55 HRc	40																			

TPKR 1603 PDTR

Material Group	Lamina Gr. N°	Material Examples	Hardness	DOC [mm]		Feed [mm/z]		Vc [m/min]		Suggested Starting Parameters										
				min	max	min	max	min	max	DOC	Feed	Vc								
P	Non Alloyed	C35, Ck45, 1020, 1045, 1060, 28Mn6	125 HB	0.50	12.00	0.13	0.22	190	330	3.00	0.17	250								
			190 HB									220								
			250 HB									200								
	Low Alloyed	2	42CrMo4, St50, Ck60, 4140, 4340, 100Cr6	180 HB	0.50	12.00	0.10	0.17	150	240	3.00	0.15	200							
				230 HB									180							
				280 HB									150							
				350 HB									140							
	High Alloyed	3	X40CrMoV5, H13, M42, D3, S6-5-2, 12Ni19	220 HB	0.50	8.60	0.08	0.15	90	150	2.30	0.13	130							
				280 HB									120							
320 HB				100																
K	7	GG20, GG40, EN-GJL-250, N030B	150 HB	0.50	12.00	0.13	0.22	150	240	3.00	0.17	200								
			200 HB									180								
			250 HB									160								
			Malleable & Nodular									8	GGG40, GGG70, 50005	150 HB	0.50	12.00	0.10	0.20	100	200
200 HB	150																			
250 HB	130																			
S	9	Incoloy 800, Inconel 700, Stellite 21	240 HB	0.50	8.60	0.08	0.13	25	45	2.30	0.12	32								
			250 HB									30								
			350 HB									30								
Ti based	10	TiAl6V4, T40	-	0.50	8.60	0.08	0.14	30	55	2.30	0.13	40								
			-									40								
H	11	X100 CrMo13, 440C, G-X260NiCr42	45 HRc	0.50	4.30	0.07	0.13	40	80	1.50	0.10	60								
			50 HRc									70								
			55 HRc									60								
			Chilled Cast Iron									Ni-Hard 2	400 HB	3.40	0.13	0.12	80	1.10	0.10	50
													55 HRc							
			White Cast Iron									G-X300CrMo15	400 HB	2.60	0.10	0.10	30	60	0.80	0.09
55 HRc	40																			
NF	12	AlSi12	130 HB	0.50	12.00	0.13	0.22	200	400	3.00	0.18	280								

TPKR 2204 PDTR

TPUN 160308

Material Group	Lamina Gr. N°	Material Examples	Hardness	DOC [mm]		Feed [mm/z]		Vc [m/min]		Suggested Starting Parameters				
				min	max	min	max	min	max	DOC	Feed	Vc		
P Non Alloyed Low Alloyed High Alloyed	1	C35, Ck45, 1020, 1045, 1060, 28Mn6	125 HB	0.50	18.00	0.13	0.22	190	330	4.00	0.17	250		
			190 HB						300			220		
			250 HB						250			200		
	2	42CrMo4, St50, Ck60, 4140, 4340, 100Cr6	180 HB	0.50	18.00	0.10	0.17	150	240	4.00	0.15	200		
			230 HB						210			180		
			280 HB				0.15	130	190			0.13	150	
			350 HB						170				140	
	3	X40CrMoV5, H13, M42, D3, S6-5-2, 12Ni19	220 HB	0.50	12.90	0.08	0.15	90	150	3.00	0.13		130	
			280 HB						130				120	
320 HB			0.13				60	110	0.12			100		
350 HB								90				80		
4	304, 316, X5CrNi18-9	180 HB	0.50	18.00	0.10	0.15	190	250		4.00	0.13	220		
		240 HB			0.08	0.14	160	210				190		
		5			X2CrNiN23-4, S31500	290 HB	0.50	12.90	0.08			0.13	70	130
310 HB	120		90											
6	410, X6Cr17, 17-4PH, 430	200 HB	0.50	18.00	0.10	0.15	150	210	4.00	0.13	190			
		42 HRc		12.90		0.13	90	150			3.00	0.12	130	
K Grey Malleable & Nodular	7	GG20, GG40, EN-GJL-250, N030B	150 HB	0.50	18.00	0.13	0.22	150	240	4.00	0.17	200		
			200 HB						220			180		
			250 HB						190			160		
	8	GGG40, GGG70, 50005	150 HB	0.50	18.00	0.10	0.20	100	200	4.00	0.15	180		
			200 HB						180			150		
250 HB	150	130												
9	Incoloy 800	240 HB	0.50	12.90	0.08	0.13	25	45	3.00	0.12	32			
		Inconel 700						45			30			
		Stellite 21						45			30			
10	TiAl6V4	-	0.50	12.90	0.08	0.14	30	55	3.00	0.13	40			
		T40				0.13	40	65			0.12	55		
H Steel Chilled Cast Iron White Cast Iron	11	X100 CrMo13, 440C, G-X260NiCr42	45 HRc	0.50	6.40	0.07	0.13	40	80	2.00	0.10	60		
			50 HRc		4.50		0.11		70			1.50	0.09	55
			55 HRc		3.90		0.10		60			1.00	0.09	50
			400 HB		5.10		0.13		80			1.50	0.10	50
			55 HRc		3.90		0.10		30			60	1.00	0.09
NF Aluminium	12	AISI12	130 HB	0.50	18.00	0.13	0.22	200	400	4.00	0.18	280		

Material Group	Lamina Gr. N°	Material Examples	Hardness	DOC [mm]		Feed [mm/z]		Vc [m/min]		Suggested Starting Parameters				
				min	max	min	max	min	max	DOC	Feed	Vc		
P Non Alloyed Low Alloyed High Alloyed	1	C35, Ck45, 1020, 1045, 1060, 28Mn6	125 HB	0.50	12.00	0.14	0.27	190	330	3.00	0.19	250		
			190 HB									220		
			250 HB									200		
	2	42CrMo4, St50, Ck60, 4140, 4340, 100Cr6	180 HB	0.50	12.00	0.12	0.21	150	240	3.00	0.17	200		
			230 HB									180		
			280 HB				0.19	170				150	0.15	140
			350 HB									140		
	3	X40CrMoV5, H13, M42, D3, S6-5-2, 12Ni19	220 HB	0.50	8.60	0.10	0.19	70	150	2.30	0.15	130		
			280 HB									120		
320 HB			0.15				90	100				0.14	80	
350 HB								80						
7	GG20, GG40, EN-GJL-250, N030B	150 HB	0.50	12.00	0.14	0.27	150	240	3.00	0.19	200			
		200 HB									180			
		250 HB									160			
8	GGG40, GGG70, 50005	150 HB	0.50	12.00	0.12	0.24	100	200	3.00	0.17	180			
		200 HB									150			
		250 HB									130			
H Steel Chilled Cast Iron White Cast Iron	11	X100 CrMo13, 440C, G-X260NiCr42	45 HRc	0.50	4.30	0.08	0.15	40	80	1.50	0.12	60		
			50 HRc		3.00		0.14		70			1.10	0.11	55
			55 HRc		2.60		0.12		60			0.80	0.10	50
			400 HB		3.40		0.15		80			1.10	0.12	50
			55 HRc		2.60		0.12		60			0.80	0.10	40

XPKT 0602-HF LT 3130

Material Group	Lamina Gr. N°	Material Examples	Hardness	DOC [mm]		Feed [mm/z]		Vc [m/min]		Suggested Starting Parameters		
				min	max	min	max	min	max	DOC	Feed	Vc
P	Non Alloyed	C35, Ck45, 1020, 1045, 1060, 28Mn6	125 HB	0.20	0.50	0.20	1.40	190	330	0.50	1.00	250
			190 HB						300			220
			250 HB						250			200
	Low Alloyed	2	42CrMo4, St50, Ck60, 4140, 4340, 100Cr6	180 HB	0.20	0.50	0.20	1.30	150	0.40	0.80	200
				230 HB					210			180
				280 HB					190			150
				350 HB					170			140
	High Alloyed	3	X40CrMoV5, H13, M42, D3, S6-5-2, 12Ni19	220 HB	0.20	0.40	0.20	1.10	90	0.40	0.70	130
				280 HB					130			120
320 HB				110					100			
Austenitic	4	304, 316, X5CrNi18-9	180 HB	0.20	0.40	0.20	0.70	190	0.40	0.50	220	
			240 HB					160			190	
			290 HB					130			100	
M Duplex	5	X2CrNiN23-4, S31500	310 HB	0.20	0.40	0.20	0.50	70	0.40	0.95	90	
			350 HB					190			80	
Ferritic & Martensitic	6	410, X6Cr17, 17-4PH, 430	200 HB	0.20	0.40	0.20	0.50	150	0.40	0.40	190	
			42 HRC					90			150	0.30

APKT 060204 PDTR LT 3130

Material Group	Lamina Gr. N°	Material Examples	Hardness	DOC [mm]		Feed [mm/z]		Vc [m/min]		Suggested Starting Parameters		
				min	max	min	max	min	max	DOC	Feed	Vc
P	Non Alloyed	C35, Ck45, 1020, 1045, 1060, 28Mn6	125 HB	0.30	5.50	0.04	0.13	190	350	1.30	0.07	265
			190 HB						320			240
			250 HB						280			215
	Low Alloyed	2	42CrMo4, St50, Ck60, 4140, 4340, 100Cr6	180 HB	0.30	5.50	0.03	0.10	150	1.30	0.06	215
				230 HB					230			200
				280 HB					210			165
				350 HB					190			155
	High Alloyed	3	X40CrMoV5, H13, M42, D3, S6-5-2, 12Ni19	220 HB	0.30	3.90	0.03	0.09	90	1.00	0.05	140
				280 HB					150			130
320 HB				120					110			
Austenitic	4	304, 316, X5CrNi18-9	240 HB	0.30	5.50	0.03	0.10	190	1.30	0.06	230	
			290 HB					160			200	
			310 HB					140			110	
M Duplex	5	X2CrNiN23-4, S31500	310 HB	0.30	3.90	0.03	0.07	70	1.00	0.05	100	
			350 HB					130			100	
Ferritic & Martensitic	6	410, X6Cr17, 17-4PH, 430	200 HB	0.30	5.50	0.03	0.10	150	1.30	0.06	200	
			42 HRC					3.90			0.03	0.08

XPKW 0602-HF LT 3130

Material Group	Lamina Gr. N°	Material Examples	Hardness	DOC [mm]		Feed [mm/z]		Vc [m/min]		Suggested Starting Parameters		
				min	max	min	max	min	max	DOC	Feed	Vc
P	Non Alloyed	C35, Ck45, 1020, 1045, 1060, 28Mn6	125 HB	0.20	0.50	0.20	1.40	190	350	0.50	1.00	265
			190 HB						320			240
			250 HB						280			215
	Low Alloyed	2	42CrMo4, St50, Ck60, 4140, 4340, 100Cr6	180 HB	0.20	0.50	0.20	1.30	150	0.40	0.80	215
				230 HB					270			200
				280 HB					230			165
				350 HB					210			155
	High Alloyed	3	X40CrMoV5, H13, M42, D3, S6-5-2, 12Ni19	220 HB	0.20	0.40	0.20	1.10	90	0.40	0.70	140
				280 HB					170			130
320 HB				150					110			
Austenitic	4	304, 316, X5CrNi18-9	240 HB	0.20	0.40	0.20	1.10	60	0.40	0.60	110	
			290 HB					170			140	
			350 HB					150			90	

APKT 100304 PDTR LT 3130

Material Group	Lamina Gr. N°	Material Examples	Hardness	DOC [mm]		Feed [mm/z]		Vc [m/min]		Suggested Starting Parameters			
				min	max	min	max	min	max	DOC	Feed	Vc	
P	Non Alloyed	C35, Ck45, 1020, 1045, 1060, 28Mn6	125 HB	0.50	9.00	0.11	0.20	190	350	2.00	0.14	265	
			190 HB						320			240	
			250 HB						280			215	
	Low Alloyed	2	42CrMo4, St50, Ck60, 4140, 4340, 100Cr6	180 HB	0.50	9.00	0.09	0.16	150	1.30	2.00	0.12	215
				230 HB					230				200
				280 HB					210				165
				350 HB					190				155
	High Alloyed	3	X40CrMoV5, H13, M42, D3, S6-5-2, 12Ni19	220 HB	0.50	6.40	0.07	0.14	90	1.00	1.50	0.11	140
				280 HB					150				130
320 HB				120					110				
Austenitic	4	304, 316, X5CrNi18-9	240 HB	0.50	9.00	0.07	0.16	190	1.30	2.00	0.12	230	
			290 HB					160				200	
			310 HB					140				100	
M Duplex	5	X2CrNiN23-4, S31500	310 HB	0.50	6.40	0.07	0.11	70	1.00	1.50	0.10	110	
			350 HB					130				100	
Ferritic & Martensitic	6	410, X6Cr17, 17-4PH, 430	200 HB	0.50	9.00	0.09	0.16	150	1.30	2.00	0.12	200	
			42 HRC					3.90				0.03	0.08

APKT 100308 PDTR LT 3130

APMT 1135 PDTR LT 3130

Material Group	Lamina Gr. N°	Material Examples	Hardness	DOC [mm]		Feed [mm/z]		Vc [m/min]		Suggested Starting Parameters			
				min	max	min	max	min	max	DOC	Feed	Vc	
P	Non Alloyed	C35, Ck45, 1020, 1045, 1060, 28Mn6	125 HB	0.50	9.00	0.13	0.26	190	350	2.00	0.17	265	
			190 HB						320			240	
			250 HB						280			215	
	Low Alloyed	2	42CrMo4, St50, Ck60, 4140, 4340, 100Cr6	180 HB	0.50	9.00	0.11	0.21	150	270	2.00	0.15	215
				230 HB						230			200
				280 HB				0.18	130	210		0.13	165
				350 HB						190			155
	High Alloyed	3	X40CrMoV5, H13, M42, D3, S6-5-2, 12Ni19	220 HB	0.50	6.40	0.08	0.18	90	170	1.50	0.13	140
				280 HB						150			130
320 HB				0.15				60	120	0.12		110	
350 HB									100			90	
M	Austenitic	4	304, 316, X5CrNi18-9	0.50	9.00	0.11	0.21	190	260	2.00	0.15	230	
						0.08	0.18	160	220			200	
	Duplex	5	X2CrNiN23-4, S31500	290 HB	0.50	6.40	0.08	0.15	70	140	1.50	0.12	110
				310 HB				0.15	130	100			
	Ferritic & Martensitic	6	410, X6Cr17, 17-4PH, 430	200 HB	0.50	9.00	0.11	0.21	150	220	2.00	0.15	200
				42 HRC				0.16	90	160			150

Material Group	Lamina Gr. N°	Material Examples	Hardness	DOC [mm]		Feed [mm/z]		Vc [m/min]		Suggested Starting Parameters			
				min	max	min	max	min	max	DOC	Feed	Vc	
P	Non Alloyed	C35, Ck45, 1020, 1045, 1060, 28Mn6	125 HB	0.50	10.00	0.13	0.22	190	350	2.00	0.15	265	
			190 HB						320			240	
			250 HB						280			215	
	Low Alloyed	2	42CrMo4, St50, Ck60, 4140, 4340, 100Cr6	180 HB	0.50	10.00	0.11	0.18	150	270	2.00	0.13	215
				230 HB						230			200
				280 HB				0.15	130	210		0.12	165
				350 HB						190			155
	High Alloyed	3	X40CrMoV5, H13, M42, D3, S6-5-2, 12Ni19	220 HB	0.50	7.20	0.08	0.15	90	170	1.50	0.12	140
				280 HB						150			130
320 HB				0.13				60	120	0.10		110	
350 HB									100			90	
M	Austenitic	4	304, 316, X5CrNi18-9	0.50	10.00	0.11	0.18	190	260	2.00	0.13	230	
						0.08	0.15	160	220			200	
	Duplex	5	X2CrNiN23-4, S31500	290 HB	0.50	7.20	0.08	0.13	70	140	1.50	0.10	110
				310 HB			0.08	130	100				
	Ferritic & Martensitic	6	410, X6Cr17, 17-4PH, 430	200 HB	0.50	10.00	0.11	0.18	150	220	2.00	0.13	200
				42 HRC									0.14

ANKX 170608 PNTR LT 3130
 APKT 1604 PDTR LT 3130
 APKT 160408 PDTR LT 3130

APMT 1604 PDTR LT 3130

Material Group	Lamina Gr. N°	Material Examples	Hardness	DOC [mm]		Feed [mm/z]		Vc [m/min]		Suggested Starting Parameters			
				min	max	min	max	min	max	DOC	Feed	Vc	
P	Non Alloyed	C35, Ck45, 1020, 1045, 1060, 28Mn6	125 HB	0.50	15.00	0.18	0.32	190	350	4.00	0.23	265	
			190 HB						320			240	
			250 HB						280			215	
	Low Alloyed	2	42CrMo4, St50, Ck60, 4140, 4340, 100Cr6	180 HB	0.50	15.00	0.15	0.25	150	270	4.00	0.20	215
				230 HB						230			200
				280 HB				0.22	130	210		0.18	165
				350 HB						190			155
	High Alloyed	3	X40CrMoV5, H13, M42, D3, S6-5-2, 12Ni19	220 HB	0.50	10.70	0.12	0.22	90	170	3.00	0.18	140
				280 HB						150			130
320 HB				0.18				60	120	0.16		110	
350 HB									100			90	
M	Austenitic	4	304, 316, X5CrNi18-9	0.50	15.00	0.15	0.25	190	260	4.00	0.20	230	
						0.12	0.22	160	220			200	
	Duplex	5	X2CrNiN23-4, S31500	290 HB	0.50	10.70	0.12	0.18	70	140	3.00	0.16	110
				310 HB						130			100
	Ferritic & Martensitic	6	410, X6Cr17, 17-4PH, 430	200 HB	0.50	15.00	0.15	0.25	150	220	4.00	0.20	200
				42 HRC									0.20

Material Group	Lamina Gr. N°	Material Examples	Hardness	DOC [mm]		Feed [mm/z]		Vc [m/min]		Suggested Starting Parameters			
				min	max	min	max	min	max	DOC	Feed	Vc	
P	Non Alloyed	C35, Ck45, 1020, 1045, 1060, 28Mn6	125 HB	0.50	15.00	0.16	0.30	190	350	4.00	0.21	265	
			190 HB						320			240	
			250 HB						280			215	
	Low Alloyed	2	42CrMo4, St50, Ck60, 4140, 4340, 100Cr6	180 HB	0.50	15.00	0.14	0.23	150	270	4.00	0.18	215
				230 HB						230			200
				280 HB				0.20	130	210		0.16	165
				350 HB						190			155
	High Alloyed	3	X40CrMoV5, H13, M42, D3, S6-5-2, 12Ni19	220 HB	0.50	10.70	0.11	0.20	90	170	3.00	0.16	140
				280 HB						150			130
320 HB				0.17				60	120	0.14		110	
350 HB									100			90	
M	Austenitic	4	304, 316, X5CrNi18-9	0.50	15.00	0.14	0.23	190	260	4.00	0.18	230	
						0.11	0.20	160	220			200	
	Duplex	5	X2CrNiN23-4, S31500	290 HB	0.50	10.70	0.11	0.17	70	140	3.00	0.14	110
				310 HB						130			100
	Ferritic & Martensitic	6	410, X6Cr17, 17-4PH, 430	200 HB	0.50	15.00	0.14	0.23	150	220	4.00	0.18	200
				42 HRC									0.19

HNKX 0604-45 LT 3130

ONKX 0806-45 LT 3130

Material Group	Lamina Gr. N°	Material Examples	Hardness	DOC [mm]		Feed [mm/z]		Vc [m/min]		Suggested Starting Parameters			
				min	max	min	max	min	max	DOC	Feed	Vc	
P	Non Alloyed	C35, Ck45, 1020, 1045, 1060, 28Mn6	125 HB	0.50	3.50	0.16	0.34	190	350	2.50	0.30	265	
			190 HB						320			240	
			250 HB						280			215	
	Low Alloyed	2	42CrMo4, St50, Ck60, 4140, 4340, 100Cr6	180 HB	0.50	3.50	0.14	0.28	150	270	2.50	0.26	215
				230 HB					230	200			
				280 HB				0.26	130	210			165
				350 HB					190	155			
	High Alloyed	3	X40CrMoV5, H13, M42, D3, S6-5-2, 12Ni19	220 HB	0.50	3.50	0.11	0.28	90	170	2.50	0.26	140
				280 HB					150	130			
320 HB				0.24				60	120	110			
350 HB								100	90				
Austenitic	4	304, 316, X5CrNi18-9	180 HB	0.50	3.50	0.14	0.30	190	260	2.50	0.26	230	
			240 HB					160	200				
M Duplex	5	X2CrNiN23-4, S31500	290 HB	0.50	3.50	0.11	0.25	70	140	2.50	0.22	110	
			310 HB					130	100				
Ferritic & Martensitic	6	410, X6Cr17, 17-4PH, 430	200 HB	0.50	3.50	0.14	0.30	150	220	2.50	0.26	200	
			42 HRC					90	160			0.22	140

Material Group	Lamina Gr. N°	Material Examples	Hardness	DOC [mm]		Feed [mm/z]		Vc [m/min]		Suggested Starting Parameters			
				min	max	min	max	min	max	DOC	Feed	Vc	
P	Non Alloyed	C35, Ck45, 1020, 1045, 1060, 28Mn6	125 HB	0.50	4.00	0.16	0.58	190	350	2.50	0.30	265	
			190 HB						320			240	
			250 HB						280			215	
	Low Alloyed	2	42CrMo4, St50, Ck60, 4140, 4340, 100Cr6	180 HB	0.50	4.00	0.14	0.50	150	270	3.00	0.40	215
				230 HB					230	200			
				280 HB				0.44	130	210			165
				350 HB					190	155			
	High Alloyed	3	X40CrMoV5, H13, M42, D3, S6-5-2, 12Ni19	220 HB	0.50	4.00	0.11	0.44	90	170	3.00	0.36	140
				280 HB					150	130			
320 HB				0.36				60	120	110			
350 HB								100	90				
Austenitic	4	304, 316, X5CrNi18-9	180 HB	0.50	1.50	0.14	0.44	190	260	1.20	0.34	230	
			240 HB					160	200				
M Duplex	5	X2CrNiN23-4, S31500	290 HB	0.50	1.50	0.11	0.36	70	140	1.20	0.30	110	
			310 HB					130	100				
Ferritic & Martensitic	6	410, X6Cr17, 17-4PH, 430	200 HB	0.50	1.50	0.14	0.44	150	220	1.20	0.34	200	
			42 HRC					90	160			0.30	140

ODMW 060508 TN LT 3130

SCMT 09T308 LT 3130

Material Group	Lamina Gr. N°	Material Examples	Hardness	DOC [mm]		Feed [mm/z]		Vc [m/min]		Suggested Starting Parameters			
				min	max	min	max	min	max	DOC	Feed	Vc	
P	Non Alloyed	C35, Ck45, 1020, 1045, 1060, 28Mn6	125 HB	0.50	4.00	0.22	0.58	190	350	3.00	0.41	265	
			190 HB						320			240	
			250 HB						280			215	
	Low Alloyed	2	42CrMo4, St50, Ck60, 4140, 4340, 100Cr6	180 HB	0.50	4.00	0.18	0.45	150	270	3.00	0.36	215
				230 HB					230	200			
				280 HB				0.40	130	210			165
				350 HB					190	155			
	High Alloyed	3	X40CrMoV5, H13, M42, D3, S6-5-2, 12Ni19	220 HB	0.50	2.90	0.14	0.40	90	170	2.30	0.32	140
				280 HB					150	130			
320 HB				0.32				60	120	110			
350 HB								100	90				

Material Group	Lamina Gr. N°	Material Examples	Hardness	DOC [mm]		Feed [mm/z]		Vc [m/min]		Suggested Starting Parameters					
				min	max	min	max	min	max	DOC	Feed	Vc			
P	Non Alloyed	C35, Ck45, 1020, 1045, 1060, 28Mn6	125 HB	0.50	9.00	0.07	0.17	190	350	2.40	0.15	265			
			190 HB						320			240			
			250 HB						280			215			
	Low Alloyed	2	42CrMo4, St50, Ck60, 4140, 4340, 100Cr6	180 HB	0.50	9.00	0.07	0.17	150	270	2.40	0.15	215		
				230 HB						230			200		
				280 HB					0.05	0.13			130	210	165
				350 HB									190	155	
	High Alloyed	3	X40CrMoV5, H13, M42, D3, S6-5-2, 12Ni19	220 HB	0.50	9.00	0.07	0.15	90	170	1.80	0.13	140		
				280 HB						150			130		
320 HB				0.05					0.10	60			120	110	
350 HB										100			90		
Austenitic	4	304, 316, X5CrNi18-9	180 HB	0.50	9.00	0.07	0.12	190	260	2.40	0.10	230			
			240 HB					160	200						
M Duplex	5	X2CrNiN23-4, S31500	290 HB	0.50	9.00	0.05	0.10	70	140	1.80	0.08	110			
			310 HB					130	100						
Ferritic & Martensitic	6	410, X6Cr17, 17-4PH, 430	200 HB	0.50	9.00	0.05	0.08	150	220	2.40	0.07	200			
			42 HRC					90	160			1.80	0.07	140	

RDMT 0702 M0 LT 3130

Material Group	Lamina Gr. N°	Material Examples	Hardness	DOC [mm]		Feed [mm/z]		Vc [m/min]		Suggested Starting Parameters				
				min	max	min	max	min	max	DOC	Feed	Vc		
P	Non Alloyed	C35, Ck45, 1020, 1045, 1060, 28Mn6	125 HB	0.50	4.00	0.16	0.58	190	350	3.00	0.46	265		
			190 HB						320			240		
			250 HB						280			215		
	Low Alloyed	2	42CrMo4, St50, Ck60, 4140, 4340, 100Cr6	180 HB	0.50	4.00	0.14	0.50	150	270	3.00	0.40	215	
				230 HB						230			200	
				280 HB				0.44	130	210			0.36	165
				350 HB						190				155
	High Alloyed	3	X40CrMoV5, H13, M42, D3, S6-5-2, 12Ni19	220 HB	0.50	4.00	0.11	0.44	90	170	3.00	0.36	140	
				280 HB						150			130	
320 HB				0.36				60	120	0.32			110	
350 HB									100				90	
M	Austenitic	4	304, 316, X5CrNi18-9	0.50	1.50	0.14	0.44	190	260	1.20	0.34	230		
												240 HB	0.11	0.40
	Duplex	5	X2CrNiN23-4, S31500	290 HB	0.50	1.50	0.11	0.36	70	1.20	0.30	110		
				310 HB								130	100	
	Ferritic & Martensitic	6	410, X6Cr17, 17-4PH, 430	200 HB	0.50	1.50	0.14	0.44	150	220	1.20	0.34	200	
				42 HRC									0.40	90

RDMT 10T3 M0 LT 3130
RXMT 10T3 M0 LT 3130

Material Group	Lamina Gr. N°	Material Examples	Hardness	DOC [mm]		Feed [mm/z]		Vc [m/min]		Suggested Starting Parameters				
				min	max	min	max	min	max	DOC	Feed	Vc		
P	Non Alloyed	C35, Ck45, 1020, 1045, 1060, 28Mn6	125 HB	0.50	2.50	0.18	0.64	190	350	1.00	0.35	265		
			190 HB						320			240		
			250 HB						280			215		
	Low Alloyed	2	42CrMo4, St50, Ck60, 4140, 4340, 100Cr6	180 HB	0.50	2.50	0.15	0.50	150	270	1.00	0.30	215	
				230 HB						230			200	
				280 HB				0.44	130	210			0.27	165
				350 HB						190				155
	High Alloyed	3	X40CrMoV5, H13, M42, D3, S6-5-2, 12Ni19	220 HB	0.50	1.80	0.12	0.44	90	170	0.80	0.27	140	
				280 HB						150			130	
320 HB				0.36				60	120	0.24			110	
350 HB									100				90	
M	Austenitic	4	304, 316, X5CrNi18-9	0.50	2.50	0.15	0.50	190	260	1.00	0.30	230		
												240 HB	0.12	0.44
	Duplex	5	X2CrNiN23-4, S31500	290 HB	0.50	2.00	0.12	0.36	70	0.80	0.24	110		
				310 HB								130	100	
	Ferritic & Martensitic	6	410, X6Cr17, 17-4PH, 430	200 HB	0.50	2.50	0.15	0.50	150	220	1.00	0.30	200	
				42 HRC									2.00	0.15

RDMT 1604 M0 LT 3130

Material Group	Lamina Gr. N°	Material Examples	Hardness	DOC [mm]		Feed [mm/z]		Vc [m/min]		Suggested Starting Parameters				
				min	max	min	max	min	max	DOC	Feed	Vc		
P	Non Alloyed	C35, Ck45, 1020, 1045, 1060, 28Mn6	125 HB	0.50	4.00	0.25	1.00	190	350	2.00	0.35	265		
			190 HB						320			240		
			250 HB						280			215		
	Low Alloyed	2	42CrMo4, St50, Ck60, 4140, 4340, 100Cr6	180 HB	0.50	4.00	0.21	0.78	150	270	2.00	0.30	215	
				230 HB						230			200	
				280 HB				0.69	130	210			0.27	165
				350 HB						190				155
	High Alloyed	3	X40CrMoV5, H13, M42, D3, S6-5-2, 12Ni19	220 HB	0.50	2.90	0.17	0.69	90	170	1.50	0.27	140	
				280 HB						150			130	
320 HB				0.56				60	120	0.24			110	
350 HB									100				90	
M	Austenitic	4	304, 316, X5CrNi18-9	0.50	4.00	0.21	0.78	190	260	2.00	0.30	230		
												240 HB	0.17	0.69
	Duplex	5	X2CrNiN23-4, S31500	290 HB	0.50	3.10	0.17	0.56	70	1.50	0.24	110		
				310 HB								130	100	
	Ferritic & Martensitic	6	410, X6Cr17, 17-4PH, 430	200 HB	0.50	4.00	0.21	0.78	150	220	2.00	0.30	200	
				42 HRC									3.10	0.63

RDMT 1204 M0 LT 3130
RXMT 1204 M0 LT 3130

Material Group	Lamina Gr. N°	Material Examples	Hardness	DOC [mm]		Feed [mm/z]		Vc [m/min]		Suggested Starting Parameters				
				min	max	min	max	min	max	DOC	Feed	Vc		
P	Non Alloyed	C35, Ck45, 1020, 1045, 1060, 28Mn6	125 HB	0.50	2.50	0.18	0.64	190	350	1.00	0.35	265		
			190 HB						320			240		
			250 HB						280			215		
	Low Alloyed	2	42CrMo4, St50, Ck60, 4140, 4340, 100Cr6	180 HB	0.50	2.50	0.15	0.50	150	270	1.00	0.30	215	
				230 HB						230			200	
				280 HB				0.44	130	210			0.27	165
				350 HB						190				155
	High Alloyed	3	X40CrMoV5, H13, M42, D3, S6-5-2, 12Ni19	220 HB	0.50	1.80	0.12	0.44	90	170	0.80	0.27	140	
				280 HB						150			130	
320 HB				0.36				60	120	0.24			110	
350 HB									100				90	
M	Austenitic	4	304, 316, X5CrNi18-9	0.50	2.50	0.15	0.50	190	260	1.00	0.30	230		
												240 HB	0.12	0.44
	Duplex	5	X2CrNiN23-4, S31500	290 HB	0.50	2.00	0.12	0.36	70	0.80	0.24	110		
				310 HB								130	100	
	Ferritic & Martensitic	6	410, X6Cr17, 17-4PH, 430	200 HB	0.50	2.50	0.15	0.50	150	220	1.00	0.30	200	
				42 HRC									2.00	0.15

RDMW 10T3 M0 LT 3130
RXMW 10T3 M0 LT 3130

Material Group	Lamina Gr. N°	Material Examples	Hardness	DOC [mm]		Feed [mm/z]		Vc [m/min]		Suggested Starting Parameters			
				min	max	min	max	min	max	DOC	Feed	Vc	
Non Alloyed	1	C35, Ck45, 1020, 1045, 1060, 28Mn6	125 HB	0.50	2.50	0.18	0.70	190	350	1.00	0.39	265	
			190 HB						320			240	
			250 HB						280			215	
Low Alloyed	2	42CrMo4, Si50, Ck60, 4140, 4340, 100Cr6	180 HB	0.50	2.50	0.15	0.55	150	270	1.00	0.34	215	
			230 HB						230			200	
			280 HB				0.48	130	210			0.31	165
			350 HB						190				155
High Alloyed	3	X40CrMoV5, H13, M42, D3, S6-5-2, 12Ni19	220 HB	0.50	1.80	0.12	0.48	90	170	0.80	0.31	140	
			280 HB						150			130	
			320 HB				0.40	60	120			0.27	110
			350 HB						100				90

RDMW 1003 M0 LT 3130

Material Group	Lamina Gr. N°	Material Examples	Hardness	DOC [mm]		Feed [mm/z]		Vc [m/min]		Suggested Starting Parameters			
				min	max	min	max	min	max	DOC	Feed	Vc	
Non Alloyed	1	C35, Ck45, 1020, 1045, 1060, 28Mn6	125 HB	0.50	4.00	0.25	1.00	190	350	2.00	0.35	265	
			190 HB						320			240	
			250 HB						280			215	
Low Alloyed	2	42CrMo4, Si50, Ck60, 4140, 4340, 100Cr6	180 HB	0.50	4.00	0.21	0.78	150	270	2.00	0.30	215	
			230 HB						230			200	
			280 HB				0.69	130	210			0.27	165
			350 HB						190				155
High Alloyed	3	X40CrMoV5, H13, M42, D3, S6-5-2, 12Ni19	220 HB	0.50	2.90	0.17	0.69	90	170	1.50	0.27	140	
			280 HB						150			130	
			320 HB				0.56	60	120			0.24	110
			350 HB						100				90

RDMW 1204 M0 LT 3130
RXMW 1204 M0 LT 3130

Material Group	Lamina Gr. N°	Material Examples	Hardness	DOC [mm]		Feed [mm/z]		Vc [m/min]		Suggested Starting Parameters			
				min	max	min	max	min	max	DOC	Feed	Vc	
Non Alloyed	1	C35, Ck45, 1020, 1045, 1060, 28Mn6	125 HB	0.50	2.50	0.18	0.70	190	350	1.00	0.39	265	
			190 HB						320			240	
			250 HB						280			215	
Low Alloyed	2	42CrMo4, Si50, Ck60, 4140, 4340, 100Cr6	180 HB	0.50	2.50	0.15	0.55	150	270	1.00	0.34	215	
			230 HB						230			200	
			280 HB				0.48	130	210			0.31	165
			350 HB						190				155
High Alloyed	3	X40CrMoV5, H13, M42, D3, S6-5-2, 12Ni19	220 HB	0.50	1.80	0.12	0.48	90	170	0.80	0.31	140	
			280 HB						150			130	
			320 HB				0.40	60	120			0.27	110
			350 HB						100				90

RXMX 10T3 M0 LT 3130

Material Group	Lamina Gr. N°	Material Examples	Hardness	DOC [mm]		Feed [mm/z]		Vc [m/min]		Suggested Starting Parameters			
				min	max	min	max	min	max	DOC	Feed	Vc	
Non Alloyed	1	C35, Ck45, 1020, 1045, 1060, 28Mn6	125 HB	0.50	2.50	0.18	0.64	190	350	1.00	0.35	265	
			190 HB						320			240	
			250 HB						280			215	
Low Alloyed	2	42CrMo4, Si50, Ck60, 4140, 4340, 100Cr6	180 HB	0.50	2.50	0.15	0.50	150	270	1.00	0.30	215	
			230 HB						230			200	
			280 HB				0.44	130	210			0.27	165
			350 HB						190				155
High Alloyed	3	X40CrMoV5, H13, M42, D3, S6-5-2, 12Ni19	220 HB	0.50	1.80	0.12	0.44	90	170	0.80	0.27	140	
			280 HB						150			130	
			320 HB				0.36	60	120			0.24	110
			350 HB						100				90
			Austenitic						4				304, 316, X5CrNi18-9
240 HB	160	220											
M Duplex	5	X2CrNiN23-4, S31500	290 HB	0.50	2.00	0.12	0.36	70	0.80	0.24	110		
			310 HB					130			100		
Ferritic & Martensitic	6	410, X6Cr17, 17-4PH, 430	200 HB	0.50	2.50	0.15	0.50	150	1.00	0.30	200		
			42 HRC					90			160	0.80	0.24

RXMX 1204 M0 LT 3130

Material Group	Lamina Gr. N°	Material Examples	Hardness	DOC [mm]		Feed [mm/z]		Vc [m/min]		Suggested Starting Parameters			
				min	max	min	max	min	max	DOC	Feed	Vc	
Non Alloyed	1	C35, Ck45, 1020, 1045, 1060, 28Mn6	125 HB	0.50	3.00	0.25	0.74	190	350	1.30	0.35	265	
			190 HB						320			240	
			250 HB						280			215	
Low Alloyed	2	42CrMo4, Si50, Ck60, 4140, 4340, 100Cr6	180 HB	0.50	3.00	0.21	0.58	150	270	1.30	0.30	215	
			230 HB						230			200	
			280 HB				0.51	130	210			0.27	165
			350 HB						190				155
High Alloyed	3	X40CrMoV5, H13, M42, D3, S6-5-2, 12Ni19	220 HB	0.50	2.20	0.17	0.51	90	170	1.00	0.27	140	
			280 HB						150			130	
			320 HB				0.41	60	120			0.24	110
			350 HB						100				90
			Austenitic						4				304, 316, X5CrNi18-9
240 HB	160	220											
M Duplex	5	X2CrNiN23-4, S31500	290 HB	0.50	2.40	0.17	0.41	70	1.00	0.24	110		
			310 HB					130			100		
Ferritic & Martensitic	6	410, X6Cr17, 17-4PH, 430	200 HB	0.50	3.00	0.21	0.58	150	1.30	0.30	200		
			42 HRC					90			160	1.00	0.24

SDKX 0904-HF LT 3130

SDKW 0904-HF LT 3130

Material Group	Lamina Gr. N°	Material Examples	Hardness	DOC [mm]		Feed [mm/z]		Vc [m/min]		Suggested Starting Parameters			
				min	max	min	max	min	max	DOC	Feed	Vc	
P	Non Alloyed	C35, Ck45, 1020, 1045, 1060, 28Mn6	125 HB	0.30	1.50	0.30	1.50	190	350	1.00	1.20	265	
			190 HB						320			240	
			250 HB						280			215	
	Low Alloyed	2	42CrMo4, St50, Ck60, 4140, 4340, 100Cr6	180 HB	0.30	1.20	0.30	1.36	150	0.80	1.00	215	
				230 HB					150			230	200
				280 HB					130			210	165
				350 HB					130			190	155
	High Alloyed	3	X40CrMoV5, H13, M42, D3, S6-5-2, 12Ni19	220 HB	0.30	1.20	0.30	1.20	90	0.70	0.80	140	
				280 HB		1.10			90			150	130
				320 HB		1.00			60			120	110
				350 HB					60			100	90
	M	Austenitic	4	304, 316, X5CrNi18-9	0.30	1.30	0.30	0.76	190	0.80	0.50	230	
240 HB									160			220	200
Duplex		5	X2CrNiN23-4, S31500	0.30	1.10	0.30	0.46	70	0.70	0.30	110		
								310 HB			130	100	
Ferritic & Martensitic		6	410, X6Cr17, 17-4PH, 430	0.30	1.20	0.30	0.52	150	220	0.80	0.40	200	
					1.00		0.46	90	160			0.70	0.30

Material Group	Lamina Gr. N°	Material Examples	Hardness	DOC [mm]		Feed [mm/z]		Vc [m/min]		Suggested Starting Parameters			
				min	max	min	max	min	max	DOC	Feed	Vc	
P	Non Alloyed	1	C35, Ck45, 1020, 1045, 1060, 28Mn6	125 HB	0.30	1.50	0.30	1.50	190	1.00	1.30	265	
				190 HB								320	240
				250 HB								280	215
	Low Alloyed	2	42CrMo4, St50, Ck60, 4140, 4340, 100Cr6	180 HB	0.30	1.30	0.30	1.36	150	0.80	1.10	215	
				230 HB								270	230
				280 HB					130			210	165
				350 HB								190	155
	High Alloyed	3	X40CrMoV5, H13, M42, D3, S6-5-2, 12Ni19	220 HB	0.30	1.30	0.30	1.20	90	0.70	0.90	140	
				280 HB		1.20						150	130
320 HB				1.10		120			110				
350 HB						60			100			90	

SDKW 1205-HF LT 3130

SDKX 1205-HF LT 3130

Material Group	Lamina Gr. N°	Material Examples	Hardness	DOC [mm]		Feed [mm/z]		Vc [m/min]		Suggested Starting Parameters			
				min	max	min	max	min	max	DOC	Feed	Vc	
P	Non Alloyed	1	C35, Ck45, 1020, 1045, 1060, 28Mn6	125 HB	0.30	2.00	0.30	2.70	190	1.20	1.70	265	
				190 HB								320	240
				250 HB								280	215
	Low Alloyed	2	42CrMo4, St50, Ck60, 4140, 4340, 100Cr6	180 HB	0.30	1.60	0.30	2.50	150	0.90	1.50	215	
				230 HB								230	200
				280 HB				130	210			165	
				350 HB					2.25			190	155
	High Alloyed	3	X40CrMoV5, H13, M42, D3, S6-5-2, 12Ni19	220 HB	0.30	1.60	0.30	2.25	90	0.70	1.20	140	
				280 HB		1.30		2.00				150	130
				320 HB		1.10		1.80	60			120	110
				350 HB				1.60	100			90	
	M	Austenitic	4	304, 316, X5CrNi18-9	0.30	1.50	0.30	1.00	190	0.90	0.80	230	
240 HB									160			220	200
Duplex		5	X2CrNiN23-4, S31500	0.30	1.20	0.30	0.65	70	0.80	0.50	110		
								310 HB			130	100	
Ferritic & Martensitic		6	410, X6Cr17, 17-4PH, 430	0.30	1.50	0.30	0.70	150	220	0.90	0.60	200	
					1.10		0.65	90	160			0.80	0.50

Material Group	Lamina Gr. N°	Material Examples	Hardness	DOC [mm]		Feed [mm/z]		Vc [m/min]		Suggested Starting Parameters			
				min	max	min	max	min	max	DOC	Feed	Vc	
P	Non Alloyed	1	C35, Ck45, 1020, 1045, 1060, 28Mn6	125 HB	0.30	2.00	0.30	2.70	190	1.30	1.70	265	
				190 HB								320	240
				250 HB								280	215
	Low Alloyed	2	42CrMo4, St50, Ck60, 4140, 4340, 100Cr6	180 HB	0.30	1.60	0.30	2.50	150	1.00	1.50	215	
				230 HB								230	200
				280 HB				130	210			165	
				350 HB					2.25			190	155
	High Alloyed	3	X40CrMoV5, H13, M42, D3, S6-5-2, 12Ni19	220 HB	0.30	1.60	0.30	2.25	90	0.80	1.20	140	
				280 HB		1.30		2.00				150	130
320 HB				1.10		1.80		60	120			110	
350 HB						1.60		100	90				

SEKT 12T3 AGSN LT 3130

SNKX 1205-45 LT 3130

Material Group	Lamina Gr. N°	Material Examples	Hardness	DOC [mm]		Feed [mm/z]		Vc [m/min]		Suggested Starting Parameters			
				min	max	min	max	min	max	DOC	Feed	Vc	
P	Non Alloyed	C35, Ck45, 1020, 1045, 1060, 28Mn6	125 HB	0.50	6.00	0.18	0.46	190	350	3.00	0.34	265	
			190 HB						190			320	240
			250 HB						190			280	215
	Low Alloyed	2	42CrMo4, St50, Ck60, 4140, 4340, 100Cr6	180 HB	0.50	6.00	0.15	0.36	150	270	3.00	0.30	215
				230 HB					150	230			200
				280 HB					130	210			165
				350 HB					130	190			155
	High Alloyed	3	X40CrMoV5, H13, M42, D3, S6-5-2, 12Ni19	220 HB	0.50	5.00	0.12	0.32	90	170	2.30	0.27	140
				280 HB					90	150			130
320 HB				60					120	110			
350 HB				60					100	90			
Austenitic	4	304, 316, X5CrNi18-9	180 HB	0.50	6.00	0.15	0.32	190	260	3.00	0.27	230	
			240 HB			0.12	0.29	160	220			200	
M Duplex	5	X2CrNiN23-4, S31500	290 HB	0.50	5.00	0.12	0.26	70	140	2.30	0.24	110	
			310 HB					70	130			100	
Ferritic & Martensitic	6	410, X6Cr17, 17-4PH, 430	200 HB	0.50	6.00	0.15	0.32	150	220	3.00	0.27	200	
			42 HRC					5.00	0.26			90	160

Material Group	Lamina Gr. N°	Material Examples	Hardness	DOC [mm]		Feed [mm/z]		Vc [m/min]		Suggested Starting Parameters			
				min	max	min	max	min	max	DOC	Feed	Vc	
P	Non Alloyed	C35, Ck45, 1020, 1045, 1060, 28Mn6	125 HB	0.50	5.00	0.16	0.34	190	350	3.00	0.30	265	
			190 HB						190			320	240
			250 HB						190			280	215
	Low Alloyed	2	42CrMo4, St50, Ck60, 4140, 4340, 100Cr6	180 HB	0.50	5.00	0.14	0.28	150	270	3.00	0.26	215
				230 HB					150	230			200
				280 HB					130	210			165
				350 HB					130	190			155
	High Alloyed	3	X40CrMoV5, H13, M42, D3, S6-5-2, 12Ni19	220 HB	0.50	5.00	0.11	0.28	90	170	3.00	0.26	140
				280 HB					90	150			130
320 HB				60					120	110			
350 HB				60					100	90			
Austenitic	4	304, 316, X5CrNi18-9	180 HB	0.50	5.00	0.14	0.30	190	260	3.00	0.26	230	
			240 HB			0.11	0.30	160	220			200	
M Duplex	5	X2CrNiN23-4, S31500	290 HB	0.50	4.00	0.11	0.25	70	140	2.50	0.22	110	
			310 HB					70	130			100	
Ferritic & Martensitic	6	410, X6Cr17, 17-4PH, 430	200 HB	0.50	5.00	0.14	0.30	150	220	3.00	0.26	200	
			42 HRC					4.00	0.25			90	160

SEKT 1204 AFTN LT 3130

SNKX 1607-45 LT 3130

Material Group	Lamina Gr. N°	Material Examples	Hardness	DOC [mm]		Feed [mm/z]		Vc [m/min]		Suggested Starting Parameters			
				min	max	min	max	min	max	DOC	Feed	Vc	
P	Non Alloyed	C35, Ck45, 1020, 1045, 1060, 28Mn6	125 HB	0.30	2.00	0.30	2.70	190	350	1.20	1.70	265	
			190 HB						190			320	240
			250 HB						190			280	215
	Low Alloyed	2	42CrMo4, St50, Ck60, 4140, 4340, 100Cr6	180 HB	0.30	1.60	0.30	2.50	150	270	0.90	1.50	215
				230 HB					150	230			200
				280 HB					130	210			165
				350 HB					130	190			155
	High Alloyed	3	X40CrMoV5, H13, M42, D3, S6-5-2, 12Ni19	220 HB	0.30	1.60	0.30	2.25	90	170	0.70	1.20	140
				280 HB		1.30		2.00	150	130			
320 HB				1.10		1.80		60	120	110			
350 HB				1.10		1.60		60	100	90			
Austenitic	4	304, 316, X5CrNi18-9	180 HB	0.30	1.50	0.30	1.00	190	260	0.90	0.80	230	
			240 HB					160	220			200	
M Duplex	5	X2CrNiN23-4, S31500	290 HB	0.30	1.20	0.30	0.65	70	140	0.80	0.50	110	
			310 HB					70	130			100	
Ferritic & Martensitic	6	410, X6Cr17, 17-4PH, 430	200 HB	0.30	1.50	0.30	0.70	150	220	0.90	0.60	200	
			42 HRC		1.10		0.65	90	160			0.80	0.50

Material Group	Lamina Gr. N°	Material Examples	Hardness	DOC [mm]		Feed [mm/z]		Vc [m/min]		Suggested Starting Parameters			
				min	max	min	max	min	max	DOC	Feed	Vc	
P	Non Alloyed	C35, Ck45, 1020, 1045, 1060, 28Mn6	125 HB	0.50	6.50	0.16	0.58	190	350	4.00	0.46	265	
			190 HB						190			320	240
			250 HB						190			280	215
	Low Alloyed	2	42CrMo4, St50, Ck60, 4140, 4340, 100Cr6	180 HB	0.50	6.50	0.14	0.50	150	270	4.00	0.40	215
				230 HB					150	230			200
				280 HB					130	210			165
				350 HB					130	190			155
	High Alloyed	3	X40CrMoV5, H13, M42, D3, S6-5-2, 12Ni19	220 HB	0.50	6.50	0.11	0.44	90	170	3.00	0.36	140
				280 HB					90	150			130
320 HB				60					120	110			
350 HB				60					100	90			
Austenitic	4	304, 316, X5CrNi18-9	180 HB	0.50	6.50	0.14	0.44	190	260	4.00	0.34	230	
			240 HB			0.11	0.40	160	220			200	
M Duplex	5	X2CrNiN23-4, S31500	290 HB	0.50	5.00	0.11	0.36	70	140	3.00	0.30	110	
			310 HB					70	130			100	
Ferritic & Martensitic	6	410, X6Cr17, 17-4PH, 430	200 HB	0.50	6.50	0.14	0.44	150	220	4.00	0.34	200	
			42 HRC					5.00	0.40			90	160

LT 05 - NON FERROUS MILLING

APGT 100304 PDER ALU

Material Group	Lamina Gr. N°	Material Examples	Hardness	DOC [mm]		Feed [mm/rev]		VC [m/min]		Suggested Starting Parameters		
				min	max	min	max	min	max	DOC	Feed	VC
AL (<8%Si) NF	13	4% < Si < 8%	100 HB	0.30	9.00	0.10	0.18	200	1200	3.00	0.14	800
		Si < 4%	60 HB			0.12	0.20					
	Copper Alloys	14	CuZn30	100HB	0.30	9.00	0.10	0.18	200	800	3.00	0.14
Non Metallic	15	Fiber Plastics	-	0.30	9.00	0.12	0.20	180	300	3.00	0.12	250
		Graphite	-									
		Hard Rubber	-									

APGT 160408 PDER ALU

Material Group	Lamina Gr. N°	Material Examples	Hardness	DOC [mm]		Feed [mm/rev]		VC [m/min]		Suggested Starting Parameters		
				min	max	min	max	min	max	DOC	Feed	VC
AL (<8%Si)	13	4% < Si < 8%	100 HB	0.50	15.00	0.13	0.29	200	1200	4.00	0.16	800
		Si < 4%	60 HB			0.15	0.32					
Copper Alloys	14	CuZn30	100HB	0.50	15.00	0.13	0.29	200	800	4.00	0.16	500
Non Metallic	15	Fiber Plastics	-	0.50	15.00	0.15	0.32	180	300	4.00	0.16	250
		Graphite	-									
		Hard Rubber	-									

SEGT 1204 AFEN ALU

Material Group	Lamina Gr. N°	Material Examples	Hardness	DOC [mm]		Feed [mm/rev]		VC [m/min]		Suggested Starting Parameters		
				min	max	min	max	min	max	DOC	Feed	VC
AL (<8%Si)	13	4% < Si < 8%	100 HB	0.30	9.00	0.10	0.35	200	1200	3.00	0.25	800
		Si < 4%	60 HB			0.12						
Copper Alloys	14	CuZn30	100HB	0.30	9.00	0.10	0.35	200	800	3.00	0.25	500
Non Metallic	15	Fiber Plastics	-	0.30	9.00	0.12	0.35	180	300	3.00	0.25	250
		Graphite	-									
		Hard Rubber	-									

MACHINING CONDITIONS

SOLID END MILLS

LT 40
LT 4000

Material Group	Lamina Gr. N°	Material Examples	Hardness	LT 40 Vc [m/min]		LT 4000 Vc [m/min]	
				min	max	min	max
Non Alloyed P Low Alloyed High Alloyed	1	C35, Ck45, 1020, 1045, 1060, 28Mn6	125 HB	70	120	150	200
			190 HB	65	110	140	190
			250 HB	60	100	120	160
	2	42CrMo4, St50, Ck60, 4140, 4340, 100Cr6	180 HB	65	110	120	180
			230 HB	60	90	90	130
			280 HB	55	85	80	120
			350 HB	55	80	60	90
	3	X40CrMoV5, H13, M42, D3, S6-5-2, 12Ni19	220 HB	60	90	70	130
			280 HB	55	80	70	110
320 HB			55	75	60	90	
350 HB			50	70	50	80	
Austenitic	4	304, 316, X5CrNi18-9	180 HB	60	80	80	120
			240 HB	50	70	70	120
Duplex	5	X2CrNiN23-4, S31500	290 HB	-	-	60	100
			310 HB	-	-	60	90
Ferritic & Martensitic	6	410, X6Cr17, 17-4PH, 430	200 HB	40	60	50	90
			42 HRc	30	45	30	60
Grey	7	GG20, GG40, EN-GJL-250, N030B	150 HB	70	120	140	200
			200 HB	65	110	150	190
			250 HB	55	100	120	160
Malleable & Nodular	8	GGG40, GGG70, 50005	150 HB	65	110	130	180
			200 HB	60	100	110	150
			250 HB	55	90	90	130
Fe, Ni & Co based	9	Incoloy 800	240 HB	-	-	30	50
		Inconel 700	250 HB	-	-	30	50
		Stellite 21	350 HB	-	-	20	50
Ti based	10	T40	-	-	-	30	60
		TiAl6V4	-	-	-	40	70
Steel	11	X100CrMo13, 440C, G-X260NiCr42	45 HRc	35	60	40	60
			50 HRc	30	50	40	60
			55 HRc	-	-	30	50
Chilled Cast Iron		Ni-Hard 2	400 HB	-	-	40	60
White Cast Iron		G-X300CrMo15	55 HRc	-	-	30	50
Aluminium	12	AlSi12	130 HB	120	180	160	250

The depth of cut and feed rate tables on the following pages are for the type and diameter specified above each table. Refer to cutting speeds on this page for recommended materials per grade.

90° 2 FLUTE | LT 40 - Ø 1 - 5

Material Group	Lamina Gr. N°	Material Examples	Hardness	Profiling		Slotting		fz [mm/tooth]				
				ap	ae	ap	Ø1.0	Ø2.0	Ø3.0	Ø4.0	Ø5.0	
Non-Alloyed	1	C35, Ck45, 1020, 1045, 1060, 28Mn6	125 HB	1.5xØ	0.5xØ	1.0xØ	0.008	0.010	0.014	0.019	0.024	
			190 HB									
			250 HB									
Low Alloyed	2	42CrMo4, St50, Ck60, 4140, 4340, 100Cr6	180 HB	1.5xØ	0.5xØ	1.0xØ	0.008	0.009	0.013	0.020	0.024	
			230 HB									
			280 HB									
			350 HB									
High Alloyed	3	X40CrMoV5, H13, M42, D3, S6-5-2, 12Ni19	220 HB	1.5xØ	0.5xØ	1.0xØ	0.007	0.008	0.012	0.017	0.021	
			280 HB									
			320 HB									
Austenitic	4	304, 316, X5CrNi18-9	180 HB	1.5xØ	0.5xØ	1.0xØ	0.006	0.007	0.010	0.014	0.017	
			240 HB									
Ferritic & Martensitic	6	410, X6Cr17, 17-4 PH, 430	200 HB	1.5xØ	0.5xØ	1.0xØ	0.004	0.005	0.007	0.011	0.013	
			42 HRc									
Grey	7	GG20, GG40, EN-GJL-250, No30B	150 HB	1.5xØ	0.5xØ	1.0xØ	0.010	0.011	0.016	0.023	0.029	
			200 HB									
			250 HB									
Malleable & Nodular	8	GGG40, GGG70, 50005	150 HB	1.5xØ	0.5xØ	1.0xØ	0.008	0.010	0.014	0.020	0.025	
			200 HB									
			250 HB									
Steel	11	X100CrMo13, 440C, G-X260NiCr42	45 HRc	1.5xØ	0.3xØ	0.2xØ	0.003	0.004	0.005	0.009	0.011	
			50 HRc									
Al (>8%Si)	12	AlSi12	130 HB	1.5xØ	0.5xØ	0.1xØ	0.009	0.010	0.015	0.021	0.026	

90° 2 FLUTE | LT 40 - Ø 6, 8, 10, 12, 16

Material Group	Lamina Gr. N°	Material Examples	Hardness	Profiling		Slotting		fz [mm/tooth]				
				ap	ae	ap	Ø6.0	Ø8.0	Ø10.0	Ø12.0	Ø16.0	
Non-Alloyed	1	C35, Ck45, 1020, 1045, 1060, 28Mn6	125 HB	1.5xØ	0.5xØ	1.0xØ	0.032	0.044	0.052	0.062	0.074	
			190 HB									
			250 HB									
Low Alloyed	2	42CrMo4, St50, Ck60, 4140, 4340, 100Cr6	180 HB	1.5xØ	0.5xØ	1.0xØ	0.031	0.042	0.050	0.059	0.071	
			230 HB									
			280 HB									
			350 HB									
High Alloyed	3	X40CrMoV5, H13, M42, D3, S6-5-2, 12Ni19	220 HB	1.5xØ	0.5xØ	1.0xØ	0.027	0.037	0.044	0.051	0.061	
			280 HB									
			320 HB									
			350 HB									
Austenitic	4	304, 316, X5CrNi18-9	180 HB	1.5xØ	0.5xØ	1.0xØ	0.022	0.030	0.036	0.042	0.050	
			240 HB									
Ferritic & Martensitic	6	410, X6Cr17, 17-4 PH, 430	200 HB	1.5xØ	0.5xØ	1.0xØ	0.017	0.023	0.028	0.032	0.039	
			42 HRc									
Grey	7	GG20, GG40, EN-GJL-250, No30B	150 HB	1.5xØ	0.5xØ	1.0xØ	0.037	0.051	0.061	0.071	0.085	
			200 HB									
			250 HB									
Malleable & Nodular	8	GGG40, GGG70, 50005	150 HB	1.5xØ	0.5xØ	1.0xØ	0.032	0.044	0.052	0.062	0.074	
			200 HB									
			250 HB									
Steel	11	X100CrMo13, 440C, G-X260NiCr42	45 HRc	1.5xØ	0.3xØ	0.2xØ	0.014	0.019	0.022	0.026	0.031	
			50 HRc									
Al (>8%Si)	12	AlSi12	130 HB	1.5xØ	0.5xØ	0.1xØ	0.034	0.046	0.055	0.065	0.077	

90° 4 FLUTE, SHORT | LT 40 Ø 1 - 5

90° 4 FLUTE, LONG | LT 40 - Ø 3 - 6

Material Group	Lamina Gr. N°	Material Examples	Hardness	Profiling		Slotting		fz [mm/tooth]				
				ap	ae	ap	Ø1.0	Ø2.0	Ø3.0	Ø4.0	Ø5.0	
P Non-Alloyed Low Alloyed High Alloyed	1	C35, Ck45, 1020, 1045, 1060, 28Mn6	125 HB	1.5xØ	0.5xØ	1.0xØ	0.008	0.010	0.014	0.019	0.024	
			190 HB									
			250 HB									
	2	42CrMo4, St50, Ck60, 4140, 4340, 100Cr6	180 HB	1.5xØ	0.5xØ	1.0xØ	0.008	0.009	0.013	0.020	0.024	
			230 HB									
			280 HB									
			350 HB									
	3	X40CrMoV5, H13, M42, D3, S6-5-2, 12Ni19	220 HB	1.5xØ	0.5xØ	1.0xØ	0.007	0.008	0.012	0.017	0.021	
			280 HB									
320 HB												
4	304, 316, X5CrNi18-9	180 HB	1.5xØ	0.5xØ	1.0xØ	0.006	0.007	0.010	0.014	0.017		
		240 HB										
		200 HB										
6	410, X6Cr17, 17-4 PH, 430	42 HRc	1.5xØ	0.5xØ	1.0xØ	0.004	0.005	0.007	0.011	0.013		
		150 HB										
7	GG20, GG40, EN-GJL-250, No30B	200 HB	1.5xØ	0.5xØ	1.0xØ	0.010	0.011	0.016	0.023	0.029		
		250 HB										
		150 HB										
8	GGG40, GGG70, 50005	200 HB	1.5xØ	0.5xØ	1.0xØ	0.008	0.010	0.014	0.020	0.025		
		250 HB										
		45 HRc										
11	X100CrMo13, 440C, G-X260NiCr42	50 HRc	1.5xØ	0.3xØ	0.2xØ	0.003	0.004	0.005	0.009	0.011		
		130 HB										
12	AISI12	130 HB	1.5xØ	0.5xØ	0.1xØ	0.009	0.010	0.015	0.021	0.026		

Material Group	Lamina Gr. N°	Material Examples	Hardness	Profiling		Slotting		fz [mm/tooth]			
				ap	ae	ap	Ø3.0	Ø4.0	Ø5.0	Ø6.0	
P Non-Alloyed Low Alloyed High Alloyed	1	C35, Ck45, 1020, 1045, 1060, 28Mn6	125 HB	1.5xØ	0.5xØ	1.0xØ	0.013	0.023	0.023	0.029	
			190 HB								
			250 HB								
	2	42CrMo4, St50, Ck60, 4140, 4340, 100Cr6	180 HB	1.5xØ	0.5xØ	1.0xØ	0.011	0.016	0.020	0.026	
			230 HB								
			280 HB								
			350 HB								
	3	X40CrMoV5, H13, M42, D3, S6-5-2, 12Ni19	220 HB	1.5xØ	0.5xØ	1.0xØ	0.009	0.013	0.016	0.020	
			280 HB								
320 HB											
350 HB											
4	304, 316, X5CrNi18-9	180 HB	1.5xØ	0.5xØ	1.0xØ	0.008	0.012	0.015	0.019		
		240 HB									
6	410, X6Cr17, 17-4 PH, 430	200 HB	1.5xØ	0.5xØ	1.0xØ	0.006	0.009	0.011	0.014		
		42 HRc									
7	GG20, GG40, EN-GJL-250, No30B	150 HB	1.5xØ	0.5xØ	1.0xØ	0.012	0.017	0.022	0.028		
		200 HB									
		250 HB									
8	GGG40, GGG70, 50005	150 HB	1.5xØ	0.5xØ	1.0xØ	0.011	0.017	0.021	0.026		
		200 HB									
		250 HB									
11	X100CrMo13, 440C, G-X260NiCr42	45 HRc	1.5xØ	0.3xØ	0.2xØ	0.004	0.006	0.008	0.010		
12	AISI12	130 HB	1.5xØ	0.5xØ	0.1xØ	0.013	0.018	0.023	0.029		

90° 4 FLUTE, SHORT | LT 40 Ø 6, 8, 10, 12, 16

90° 4 FLUTE, LONG | LT 40 - Ø 8, 10, 12, 16

Material Group	Lamina Gr. N°	Material Examples	Hardness	Profiling		Slotting		fz [mm/tooth]				
				ap	ae	ap	Ø6.0	Ø8.0	Ø10.0	Ø12.0	Ø16.0	
P Non-Alloyed Low Alloyed High Alloyed	1	C35, Ck45, 1020, 1045, 1060, 28Mn6	125 HB	1.5xØ	0.5xØ	1.0xØ	0.032	0.044	0.052	0.062	0.084	
			190 HB									
			250 HB									
	2	42CrMo4, St50, Ck60, 4140, 4340, 100Cr6	180 HB	1.5xØ	0.5xØ	1.0xØ	0.031	0.042	0.050	0.059	0.074	
			230 HB									
			280 HB									
			350 HB									
	3	X40CrMoV5, H13, M42, D3, S6-5-2, 12Ni19	220 HB	1.5xØ	0.5xØ	1.0xØ	0.027	0.037	0.044	0.051	0.059	
			280 HB									
320 HB												
350 HB												
4	304, 316, X5CrNi18-9	180 HB	1.5xØ	0.5xØ	1.0xØ	0.022	0.030	0.036	0.042	0.054		
		240 HB										
6	410, X6Cr17, 17-4 PH, 430	200 HB	1.5xØ	0.5xØ	1.0xØ	0.017	0.023	0.028	0.032	0.040		
		42 HRc										
7	GG20, GG40, EN-GJL-250, No30B	150 HB	1.5xØ	0.5xØ	1.0xØ	0.037	0.051	0.061	0.071	0.079		
		200 HB										
		250 HB										
8	GGG40, GGG70, 50005	150 HB	1.5xØ	0.5xØ	1.0xØ	0.032	0.044	0.052	0.062	0.075		
		200 HB										
		250 HB										
11	X100CrMo13, 440C, G-X260NiCr42	45 HRc	1.5xØ	0.3xØ	0.2xØ	0.014	0.019	0.022	0.026	0.029		
		50 HRc										
12	AISI12	130 HB	1.5xØ	0.5xØ	0.1xØ	0.034	0.046	0.055	0.065	0.084		

Material Group	Lamina Gr. N°	Material Examples	Hardness	Profiling		Slotting		fz [mm/tooth]			
				ap	ae	ap	Ø8.0	Ø10.0	Ø12.0	Ø16.0	
P Non-Alloyed Low Alloyed High Alloyed	1	C35, Ck45, 1020, 1045, 1060, 28Mn6	125 HB	1.5xØ	0.5xØ	1.0xØ	0.040	0.048	0.056	0.076	
			190 HB								
			250 HB								
	2	42CrMo4, St50, Ck60, 4140, 4340, 100Cr6	180 HB	1.5xØ	0.5xØ	1.0xØ	0.036	0.042	0.050	0.068	
			230 HB								
			280 HB								
			350 HB								
	3	X40CrMoV5, H13, M42, D3, S6-5-2, 12Ni19	220 HB	1.5xØ	0.5xØ	1.0xØ	0.028	0.033	0.039	0.053	
			280 HB								
320 HB											
350 HB											
4	304, 316, X5CrNi18-9	180 HB	1.5xØ	0.5xØ	1.0xØ	0.026	0.031	0.036	0.049		
		240 HB									
6	410, X6Cr17, 17-4 PH, 430	200 HB	1.5xØ	0.5xØ	1.0xØ	0.019	0.023	0.027	0.036		
		42 HRc									
7	GG20, GG40, EN-GJL-250, No30B	150 HB	1.5xØ	0.5xØ	1.0xØ	0.038	0.045	0.053	0.072		
		200 HB									
		250 HB									
8	GGG40, GGG70, 50005	150 HB	1.5xØ	0.5xØ	1.0xØ	0.036	0.043	0.050	0.068		
		200 HB									
		250 HB									
11	X100CrMo13, 440C, G-X260NiCr42	45 HRc	1.5xØ	0.3xØ	0.2xØ	0.014	0.017	0.020	0.027		
12	AISI12	130 HB	1.5xØ	0.5xØ	0.1xØ	0.040	0.048	0.056	0.076		

MACHINING CONDITIONS | SOLID END MILLS - DEPTH OF CUT AND FEED

BALL NOSE 2 FLUTE | LT 40 - Ø 1 - 5

Material Group	Lamina Gr. N°	Material Examples*	Hardness	Contouring		fz [mm/tooth]				
				ap	ae	Ø1.0	Ø2.0	Ø3.0	Ø4.0	Ø5.0
P Non-Alloyed Low Alloyed High Alloyed	1	C35, Ck45, 1020, 1045, 1060, 28Mn6	125 HB	0.25xØ	0.7xØ	0.028	0.036	0.052	0.064	0.084
			190 HB							
			250 HB							
	2	42CrMo4, S150, Ck60, 4140, 4340, 100Cr6	180 HB	0.25xØ	0.7xØ	0.021	0.027	0.039	0.048	0.063
			230 HB							
			280 HB			0.018	0.023	0.033	0.041	0.054
			350 HB							
	3	X40CrMoV5, H13, M42, D3, S6-5-2, 12Ni19	220 HB	0.25xØ	0.7xØ	0.018	0.023	0.033	0.040	0.053
			280 HB							
320 HB			0.013			0.017	0.025	0.031	0.040	
350 HB										
M Austenitic	4	304, 316, X5CrNi18-9	180 HB	0.25xØ	0.7xØ	0.015	0.019	0.027	0.033	0.044
			240 HB							
M Ferritic & Martensitic	6	410, X6Cr17, 17-4 PH, 430	200 HB	0.25xØ	0.7xØ	0.015	0.020	0.028	0.035	0.046
			42 HRc							
K Grey Malleable & Nodular	7	GG20, GG40, EN-GJL-250, No30B	150 HB	0.25xØ	0.7xØ	0.025	0.032	0.046	0.056	0.074
			200 HB							
			250 HB							
	8	GGG40, GGG70, 50005	150 HB	0.25xØ	0.7xØ	0.021	0.027	0.040	0.049	0.064
			200 HB							
250 HB	250 HB									
		H Steel	11	X100CrMo13, 440C, G-X260NiCr42	45 HRc	0.25xØ	0.6xØ	0.009	0.012	0.017
50 HRc										
NF Al (>8%Si)	12	AlSi12	130 HB	0.25xØ	0.7xØ	0.022	0.029	0.042	0.051	0.067

BALL NOSE 2 FLUTE | LT 40 - Ø 6, 8, 10, 12, 16

Material Group	Lamina Gr. N°	Material Examples*	Hardness	Contouring		fz [mm/tooth]				
				ap	ae	Ø6.0	Ø8.0	Ø10.0	Ø12.0	Ø16.0
P Non-Alloyed Low Alloyed High Alloyed	1	C35, Ck45, 1020, 1045, 1060, 28Mn6	125 HB	0.25xØ	0.7xØ	0.080	0.092	0.100	0.112	0.106
			190 HB							
			250 HB							
	2	42CrMo4, S150, Ck60, 4140, 4340, 100Cr6	180 HB	0.25xØ	0.7xØ	0.060	0.069	0.075	0.084	0.080
			230 HB							
			280 HB			0.051	0.059	0.064	0.072	0.068
			350 HB							
	3	X40CrMoV5, H13, M42, D3, S6-5-2, 12Ni19	220 HB	0.25xØ	0.7xØ	0.051	0.058	0.063	0.071	0.067
			280 HB							
320 HB			0.038			0.044	0.048	0.054	0.051	
350 HB										
M Austenitic	4	304, 316, X5CrNi18-9	180 HB	0.25xØ	0.7xØ	0.042	0.048	0.052	0.058	0.055
			240 HB							
M Ferritic & Martensitic	6	410, X6Cr17, 17-4 PH, 430	200 HB	0.25xØ	0.7xØ	0.044	0.050	0.054	0.061	0.058
			42 HRc							
K Grey Malleable & Nodular	7	GG20, GG40, EN-GJL-250, No30B	150 HB	0.25xØ	0.7xØ	0.070	0.081	0.088	0.099	0.093
			200 HB							
			250 HB							
8	GGG40, GGG70, 50005	150 HB	0.25xØ	0.7xØ	0.061	0.070	0.076	0.085	0.081	
		200 HB								
		250 HB								
H Steel	11	X100CrMo13, 440C, G-X260NiCr42	45 HRc	0.25xØ	0.6xØ	0.026	0.029	0.032	0.036	0.034
			50 HRc							
NF Al (>8%Si)	12	AlSi12	130 HB	0.25xØ	0.7xØ	0.064	0.074	0.080	0.090	0.085

MACHINING CONDITIONS | SOLID END MILLS - DEPTH OF CUT AND FEED

90° 2 FLUTE | LT 4000 - Ø 1 - 5

Material Group	Lamina Gr. N°	Material Examples	Hardness	Profiling		Slotting		fz [mm/tooth]											
				ap	ae	ap	Ø 1	Ø 2	Ø 3	Ø 4	Ø 5								
P Non Alloyed Low Alloyed High Alloyed	1	C35, Ck45, 1020, 1045, 1060, 28Mn6	125 HB	1.5xØ	0.5xØ	1.0xØ	0.010	0.012	0.017	0.024	0.030								
			190 HB																
			250 HB																
	2	42CrMo4, S150, Ck60, 4140, 4340, 100Cr6	180 HB	1.5xØ	0.5xØ	1.0xØ	0.110	0.011	0.016	0.025	0.030								
			230 HB																
			280 HB									1.5xØ	0.5xØ	0.7xØ	0.007	0.009	0.014	0.020	0.024
			350 HB																
	3	X40CrMoV5, H13, M42, D3, S6-5-2, 12Ni19	220 HB	1.5xØ	0.5xØ	1.0xØ	0.009	0.010	0.015	0.021	0.026								
			280 HB																
320 HB			1.5xØ									0.5xØ	0.6xØ	0.007	0.008	0.011	0.016	0.020	
350 HB																			
M Austenitic	4	304, 316, X5CrNi18-9	180 HB	1.5xØ	0.5xØ	1.0xØ	0.007	0.008	0.012	0.017	0.022								
			240 HB																
M Duplex	5	X2CrNiN23-4, S31500	290 HB	1.5xØ	0.5xØ	1.0xØ	0.006	0.006	0.009	0.013	0.017								
			310 HB																
M Ferritic & Martensitic	6	410, X6Cr17, 17-4PH, 430	200 HB	1.5xØ	0.5xØ	1.0xØ	0.006	0.006	0.009	0.013	0.017								
			42 HRc																
K Grey Malleable & Nodular	7	GG20, GG40, EN-GJL-250, N030B	150 HB	1.5xØ	0.5xØ	1.0xØ	0.012	0.014	0.020	0.029	0.036								
			200 HB																
			250 HB																
8	GG20, GG70, 50005	150 HB	1.5xØ	0.5xØ	1.0xØ	0.010	0.012	0.017	0.025	0.031									
		200 HB																	
		250 HB																	
S Fe, Ni & Co based	9	Incoloy 800, Inconel 700, Stellite 21	240 HB	1.5xØ	0.3xØ	1.0xØ	0.006	0.007	0.010	0.014	0.018								
			250 HB																
			350 HB																
S Ti based	10	TiAl6V4, T40	-	1.5xØ	0.5xØ	1.0xØ	0.006	0.007	0.010	0.015	0.018								
			-																
H Steel Chilled Cast Iron White Cast Iron	11	X100 CrMo13, 440C, G-X260NiCr42	45 HRc	1.5xØ	0.3xØ	0.2xØ	0.004	0.007	0.007	0.011	0.013								
			50 HRc																
			55 HRc																
	12	Ni-Hard 2	400 HB	1.5xØ	0.2xØ	0.1xØ	0.003	0.005	0.005	0.008	0.010								
			55 HRc																
13	G-X300CrMo15	55 HRc	1.5xØ	0.2xØ	0.1xØ	0.003	0.005	0.005	0.008	0.010									
		55 HRc																	
NF Aluminium	14	AlSi12	130 HB	1.5xØ	0.5xØ	1.0xØ	0.011	0.018	0.018	0.027	0.033								

90° 2 FLUTE | LT 4000 - Ø 6, 8, 10, 12

Material Group	Lamina Gr. N°	Material Examples	Hardness	Profiling		Slotting		fz [mm/tooth]									
				ap	ae	ap	Ø 6	Ø 8	Ø 10	Ø 12							
P Non Alloyed Low Alloyed High Alloyed	1	C35, Ck45, 1020, 1045, 1060, 28Mn6	125 HB	1.5xØ	0.5xØ	1.0xØ	0.040	0.055	0.065	0.077							
			190 HB														
			250 HB														
	2	42CrMo4, S150, Ck60, 4140, 4340, 100Cr6	180 HB	1.5xØ	0.5xØ	1.0xØ	0.039	0.053	0.063	0.074							
			230 HB														
			280 HB								1.5xØ	0.5xØ	0.7xØ	0.032	0.043	0.052	0.062
			350 HB														
	3	X40CrMoV5, H13, M42, D3, S6-5-2, 12Ni19	220 HB	1.5xØ	0.5xØ	1.0xØ	0.033	0.046	0.055	0.064							
			280 HB														
320 HB			1.5xØ								0.5xØ	0.6xØ	0.025	0.035	0.041	0.049	
350 HB																	
M Austenitic	4	304, 316, X5CrNi18-9	180 HB	1.5xØ	0.5xØ	1.0xØ	0.028	0.038	0.045	0.053							
			240 HB														
M Duplex	5	X2CrNiN23-4, S31500	290 HB	1.5xØ	0.5xØ	1.0xØ	0.021	0.029	0.035	0.040							
			310 HB														
M Ferritic & Martensitic	6	410, X6Cr17, 17-4PH, 430	200 HB	1.5xØ	0.5xØ	1.0xØ	0.021	0.029	0.035	0.040							
			42 HRc														
K Grey Malleable & Nodular	7	GG20, GG40, EN-GJL-250, N030B	150 HB	1.5xØ	0.5xØ	1.0xØ	0.047	0.064	0.076	0.089							
			200 HB														
			250 HB														
8	GG20, GG70, 50005	150 HB	1.5xØ	0.5xØ	1.0xØ	0.040	0.055	0.066	0.077								
		200 HB															
		250 HB															
S Fe, Ni & Co based	9	Incoloy 800, Inconel 700, Stellite 21	240 HB	1.5xØ	0.3xØ	1.0xØ	0.023	0.031	0.037	0.044							
			250 HB														
			350 HB														
S Ti based	10	TiAl6V4, T40	-	1.5xØ	0.5xØ	1.0xØ	0.023	0.032	0.038	0.045							
			-														
H Steel Chilled Cast Iron White Cast Iron	11	X100 CrMo13, 440C, G-X260NiCr42	45 HRc	1.5xØ	0.3xØ	0.2xØ	0.017	0.023	0.028	0.032							
			50 HRc														
			55 HRc														
	12	Ni-Hard 2	400 HB	1.5xØ	0.2xØ	0.1xØ	0.013	0.017	0.021	0.024							
			55 HRc														
13	G-X300CrMo15	55 HRc	1.5xØ	0.2xØ	0.1xØ	0.013	0.017	0.021	0.024								
		55 HRc															
NF Aluminium	14	AlSi12	130 HB	1.5xØ	0.5xØ	1.0xØ	0.042	0.058	0.069	0.081							

MACHINING CONDITIONS | SOLID END MILLS - DEPTH OF CUT AND FEED

90° 3 FLUTE | LT 4000 - Ø 3 - 6, 8, 10, 12

Material Group	Lamina Gr. N°	Material Examples	Hardness	Profiling		Slotting		fz [mm/tooth]					
				ap	ae	ap	Ø 3	Ø 4	Ø 5	Ø 6	Ø 8	Ø 10	Ø 12
P Non Alloyed Low Alloyed High Alloyed	1	C35, Ck45, 1020, 1045, 1060, 28Mn6	125 HB	1.5xØ	0.5xØ	1.0xØ	0.018	0.027	0.033	0.042	0.058	0.069	0.081
			190 HB										
			250 HB										
	2	42CrMo4, S150, Ck60, 4140, 4340, 100Cr6	180 HB	1.5xØ	0.5xØ	1.0xØ	0.017	0.025	0.031	0.040	0.054	0.065	0.076
			230 HB										
			280 HB										
			350 HB										
	3	X40CrMoV5, H13, M42, D3, S6-5-2, 12Ni19	220 HB	1.5xØ	0.5xØ	1.0xØ	0.015	0.021	0.026	0.033	0.046	0.055	0.064
			280 HB										
320 HB													
4	304, 316, X5CrNi18-9	180 HB	1.5xØ	0.5xØ	1.0xØ	0.012	0.017	0.022	0.028	0.038	0.045	0.053	
		240 HB											
M Duplex	5	X2CrNiN23-4, S31500	290 HB	1.5xØ	0.5xØ	1.0xØ	0.009	0.013	0.017	0.021	0.029	0.035	0.040
			310 HB										
M Ferritic & Martensitic	6	410, X6Cr17, 17-4PH, 430	200 HB	1.5xØ	0.5xØ	1.0xØ	0.009	0.013	0.016	0.020	0.028	0.033	0.039
			42 HRc										
K Grey	7	GG20, GG40, EN-GJL-250, N030B	150 HB	1.5xØ	0.5xØ	1.0xØ	0.020	0.029	0.036	0.047	0.064	0.076	0.089
			200 HB										
			250 HB										
K Malleable & Nodular	8	GGG40, GGG70, 50005	150 HB	1.5xØ	0.5xØ	1.0xØ	0.017	0.025	0.031	0.040	0.055	0.066	0.077
			200 HB										
			250 HB										
S Fe, Ni & Co based	9	Incoloy 800 Inconel 700 Stellite 21	240 HB	1.5xØ	0.3xØ	1.0xØ	0.010	0.014	0.018	0.023	0.031	0.037	0.044
			250 HB										
			350 HB										
S Ti based	10	T40 TiAl6V4	-	1.5xØ	0.5xØ	1.0xØ	0.007	0.011	0.013	0.017	0.023	0.028	0.032
			-										
H Steel	11	X100CrMo13, 440C, G-X260NiCr42	45 HRc	1.5xØ	0.3xØ	0.2xØ	0.006	0.009	0.012	0.015	0.020	0.024	0.028
			50 HRc										
			55 HRc										
H Chilled Cast Iron	12	Ni-Hard 2	400 HB	1.5xØ	0.2xØ	0.1xØ	0.006	0.008	0.010	0.013	0.017	0.021	0.024
			55 HRc										
H White Cast Iron	13	G-X300CrMo15	55 HRc	1.5xØ	0.2xØ	0.1xØ	0.006	0.008	0.010	0.013	0.017	0.021	0.024
NF Aluminium	14	AlSi12	130 HB	1.5xØ	0.5xØ	1.0xØ	0.018	0.027	0.033	0.042	0.058	0.0696	0.081

MACHINING CONDITIONS | SOLID END MILLS - DEPTH OF CUT AND FEED

90° 4 FLUTE | LT 4000 - Ø 1 - 5

Material Group	Lamina Gr. N°	Material Examples	Hardness	Profiling		Slotting		fz [mm/tooth]				
				ap	ae	ap	Ø 1	Ø 2	Ø 3	Ø 4	Ø 5	
P Non Alloyed Low Alloyed High Alloyed	1	C35, Ck45, 1020, 1045, 1060, 28Mn6	125 HB	1.5xØ	0.5xØ	1.0xØ	0.010	0.011	0.016	0.023	0.029	
			190 HB									
			250 HB									
	2	42CrMo4, S150, Ck60, 4140, 4340, 100Cr6	180 HB	1.5xØ	0.5xØ	1.0xØ	0.008	0.010	0.014	0.020	0.025	
			230 HB									
			280 HB									
			350 HB									
	3	X40CrMoV5, H13, M42, D3, S6-5-2, 12Ni19	220 HB	1.5xØ	0.5xØ	1.0xØ	0.007	0.008	0.011	0.016	0.020	
			280 HB									
320 HB												
4	304, 316, X5CrNi18-9	180 HB	1.5xØ	0.5xØ	1.0xØ	0.006	0.007	0.010	0.015	0.019		
		240 HB										
M Duplex	5	X2CrNiN23-4, S31500	290 HB	1.5xØ	0.5xØ	1.0xØ	0.005	0.006	0.008	0.011	0.014	
			310 HB									
M Ferritic & Martensitic	6	410, X6Cr17, 17-4PH, 430	200 HB	1.5xØ	0.5xØ	1.0xØ	0.005	0.005	0.008	0.011	0.014	
			42 HRc									
K Grey	7	GG20, GG40, EN-GJL-250, N030B	150 HB	1.5xØ	0.5xØ	1.0xØ	0.009	0.011	0.015	0.022	0.027	
			200 HB									
			250 HB									
K Malleable & Nodular	8	GGG40, GGG70, 50005	150 HB	1.5xØ	0.5xØ	1.0xØ	0.009	0.010	0.014	0.021	0.026	
			200 HB									
			250 HB									
S Fe, Ni & Co based	9	Incoloy 800 Inconel 700 Stellite 21	240 HB	1.5xØ	0.3xØ	1.0xØ	0.004	0.004	0.006	0.009	0.011	
			250 HB									
			350 HB									
S Ti based	10	T40 TiAl6V4	-	1.5xØ	0.5xØ	1.0xØ	0.004	0.004	0.006	0.009	0.011	
			-									
H Steel	11	X100CrMo13, 440C, G-X260NiCr42	45 HRc	1.5xØ	0.3xØ	0.2xØ	0.003	0.004	0.006	0.008	0.010	
			50 HRc									
			55 HRc									
H Chilled Cast Iron	12	Ni-Hard 2	400 HB	1.5xØ	0.2xØ	0.1xØ	0.003	0.003	0.005	0.007	0.009	
			55 HRc									
H White Cast Iron	13	G-X300CrMo15	55 HRc	1.5xØ	0.2xØ	0.1xØ	0.003	0.003	0.005	0.007	0.009	
NF Aluminium	14	AlSi12	130 HB	1.5xØ	0.5xØ	1.0xØ	0.010	0.011	0.016	0.023	0.029	

90° 4 FLUTE | LT 4000 - Ø 6, 8, 10, 12, 16

Material Group	Lamina Gr. N°	Material Examples	Hardness	Profiling		Slotting		fz [mm/tooth]				
				ap	ae	ap	Ø 6	Ø 8	Ø 10	Ø 12	Ø 16	
P Non Alloyed Low Alloyed High Alloyed	1	C35, Ck45, 1020, 1045, 1060, 28Mn6	125 HB	1.5xØ	0.5xØ	1.0xØ	0.050	0.059	0.070	0.099	0.095	
			190 HB									
			250 HB									
	2	42CrMo4, S150, Ck60, 4140, 4340, 100Cr6	180 HB	1.5xØ	0.5xØ	1.0xØ	0.044	0.053	0.062	0.088	0.085	
			230 HB									
			280 HB									
			350 HB									
	3	X40CrMoV5, H13, M42, D3, S6-5-2, 12Ni19	220 HB	1.5xØ	0.5xØ	1.0xØ	0.035	0.042	0.049	0.069	0.067	
			280 HB									
320 HB												
4	304, 316, X5CrNi18-9	180 HB	1.5xØ	0.5xØ	1.0xØ	0.032	0.039	0.045	0.064	0.062		
		240 HB										
M Duplex	5	X2CrNiN23-4, S31500	290 HB	1.5xØ	0.5xØ	1.0xØ	0.025	0.030	0.035	0.050	0.048	
			310 HB									
M Ferritic & Martensitic	6	410, X6Cr17, 17-4PH, 430	200 HB	1.5xØ	0.5xØ	1.0xØ	0.024	0.029	0.033	0.048	0.046	
			42 HRc									
K Grey	7	GG20, GG40, EN-GJL-250, N030B	150 HB	1.5xØ	0.5xØ	1.0xØ	0.047	0.056	0.066	0.094	0.090	
			200 HB									
			250 HB									
K Malleable & Nodular	8	GGG40, GGG70, 50005	150 HB	1.5xØ	0.5xØ	1.0xØ	0.045	0.053	0.063	0.089	0.086	
			200 HB									
			250 HB									
S Fe, Ni & Co based	9	Incoloy 800 Inconel 700 Stellite 21	240 HB	1.5xØ	0.3xØ	1.0xØ	0.020	0.024	0.028	0.040	0.038	
			250 HB									
			350 HB									
S Ti based	10	T40 TiAl6V4	-	1.5xØ	0.5xØ	1.0xØ	0.020	0.024	0.028	0.040	0.038	
			-									
H Steel	11	X100CrMo13, 440C, G-X260NiCr42	45 HRc	1.5xØ	0.3xØ	0.2xØ	0.017	0.021	0.024	0.035	0.033	
			50 HRc									
			55 HRc									
H Chilled Cast Iron	12	Ni-Hard 2	400 HB	1.5xØ	0.2xØ	0.1xØ	0.015	0.018	0.021	0.030	0.029	
			55 HRc									
H White Cast Iron	13	G-X300CrMo15	55 HRc	1.5xØ	0.2xØ	0.1xØ	0.015	0.018	0.021	0.030	0.029	
NF Aluminium	14	AlSi12	130 HB	1.5xØ	0.5xØ	1.0xØ	0.050	0.059	0.070	0.099	0.095	

HIGH FEED, 4 FLUTE – LT 4000 - Ø 3 - 6, 8, 10, 12

Material Group	Lamina Gr. N°	Material Examples	Hardness	Profiling		fz [mm/tooth]						
				ap	ae	Ø 3	Ø 4	Ø 5	Ø 6	Ø 8	Ø 10	Ø 12
Non Alloyed	1	C35, Ck45, 1020, 1045, 1060, 28Mn6	125 HB	0.025xØ	0.5xØ	0.140	0.200	0.240	0.260	0.340	0.400	0.450
			190 HB									
			250 HB									
Low Alloyed	2	42CrMo4, St50, Ck60, 4140, 4340, 100Cr6	180 HB	0.025xØ	0.5xØ	0.132	0.188	0.226	0.244	0.320	0.376	0.423
			230 HB									
			280 HB									
			350 HB									
High Alloyed	3	X40CrMoV5, H13, M42, D3, S6-5-2, 12Ni19	220 HB	0.025xØ	0.5xØ	0.111	0.158	0.190	0.205	0.269	0.316	0.356
			280 HB									
			320 HB			0.084	0.120	0.144	0.156	0.204	0.240	0.270
			350 HB									
Grey	7	GG20, GG40, EN-GJL-250, N030B	150 HB	0.025xØ	0.5xØ	0.154	0.220	0.264	0.286	0.374	0.440	0.495
			200 HB									
			250 HB									
Malleable & Nodular	8	GG20, GG70, 50005	150 HB	0.025xØ	0.5xØ	0.133	0.190	0.228	0.247	0.323	0.380	0.428
			200 HB									
			250 HB									
Steel	11	X100 CrMo13, 440C, G-X260NiCr42	45 HRc	0.025xØ	0.5xØ	0.070	0.100	0.120	0.130	0.170	0.200	0.225
			50 HRc									
			55 HRc									
Chilled Cast Iron	12	Ni-Hard 2	400 HB	0.025xØ	0.3xØ	0.056	0.080	0.096	0.104	0.136	0.160	0.180
			55 HRc									
White Cast Iron	13	G-X300CrMo15	55 HRc	0.025xØ	0.3xØ	0.056	0.080	0.096	0.104	0.136	0.160	0.180

MACHINING
CONDITIONS

THREAD
TURNING

THREAD
MILLING

Material Group	Lamina Gr. N°	Material Examples	Hardness	Vc [m/min]	
				min	max
Non Alloyed	1	C35, Ck45, 1020, 1045, 1060, 28Mn6	125 HB	120	200
			190 HB	110	180
			250 HB	100	170
Low Alloyed P	2	42CrMo4, St50, Ck60, 4140, 4340, 100Cr6	180 HB	100	170
			230 HB		
			280 HB	70	120
			350 HB	60	90
High Alloyed	3	X40CrMoV5, H13, M42, D3, S6-5-2, 12Ni19	220 HB	100	170
			280 HB		
			320 HB	70	120
			350 HB	60	90
Austenitic	4	304, 316, X5CrNi18-9	180 HB	70	140
			240 HB	80	120
M Duplex	5	X2CrNiN23-4, S31500	290 HB	50	110
			310 HB		
Ferritic & Martensitic	6	410, X6Cr17, 17-4PH, 430	200 HB	70	140
			42 HRC	50	110
Grey	7	GG20, GG40, EN-GJL-250, N030B	150 HB	70	150
			200 HB	100	140
			250 HB	70	120
K Malleable & Nodular	8	GGG40, GGG70, 50005	150 HB	70	150
			200 HB	100	140
			250 HB	70	120
S Fe, Ni & Co based	9	Incoloy 800	240 HB	40	60
		Inconel 700	250 HB	30	50
		Stellite 21	350 HB	20	40
Ti based	10	T40	-	50	70
		TiAl6V4	-	40	60
H Steel	11	X100 CrMo13, 440C, G-X260NiCr42	45 HRC	30	50
			50 HRC		
			55 HRC		
		Ni-Hard 2	400 HB	40	
White Cast Iron	G-X300CrMo15	55 HRC			
NF Aluminium	12	AlSi12	130 HB	100	400

RECOMMENDED NUMBER OF PASSES

ISO METRIC - EXTERNAL

No. OF PASSES	PITCH (MM)										
	4	3.5	3	2.5	2	1.75	1.5	1.25	1	0.75	0.5
1	0.34	0.34	0.27	0.26	0.24	0.23	0.23	0.20	0.19	0.17	0.11
2	0.30	0.31	0.23	0.22	0.23	0.21	0.21	0.18	0.16	0.15	0.09
3	0.25	0.24	0.20	0.20	0.19	0.16	0.18	0.14	0.13	0.11	0.08
4	0.21	0.20	0.18	0.17	0.17	0.14	0.16	0.12	0.10	0.06	0.06
5	0.19	0.19	0.17	0.16	0.15	0.12	0.11	0.10	0.06		
6	0.18	0.17	0.16	0.14	0.12	0.10	0.06	0.06			
7	0.16	0.16	0.15	0.13	0.10	0.08					
8	0.15	0.15	0.13	0.12	0.06	0.06					
9	0.15	0.14	0.12	0.10							
10	0.14	0.12	0.11	0.06							
11	0.13	0.10	0.09								
12	0.12	0.06	0.06								
13	0.10										
14	0.06										
Total	2.48	2.18	1.87	1.56	1.26	1.10	0.95	0.80	0.64	0.49	0.34

DEPTH OF CUT

ISO METRIC - INTERNAL

No. OF PASSES	PITCH (MM)										
	4	3.5	3	2.5	2	1.75	1.5	1.25	1	0.75	0.5
1	0.32	0.32	0.25	0.25	0.23	0.22	0.22	0.19	0.18	0.16	0.10
2	0.27	0.29	0.22	0.21	0.21	0.20	0.20	0.16	0.15	0.14	0.09
3	0.22	0.23	0.19	0.19	0.18	0.15	0.17	0.13	0.12	0.10	0.07
4	0.20	0.19	0.17	0.16	0.16	0.13	0.15	0.11	0.10	0.06	0.06
5	0.19	0.18	0.16	0.15	0.14	0.11	0.10	0.10	0.06		
6	0.18	0.16	0.16	0.13	0.11	0.09	0.06	0.06			
7	0.16	0.15	0.14	0.12	0.09	0.08					
8	0.15	0.14	0.12	0.11	0.06	0.06					
9	0.14	0.13	0.11	0.09							
10	0.14	0.11	0.10	0.06							
11	0.12	0.09	0.08								
12	0.10	0.06	0.06								
13	0.09										
14	0.06										
Total	2.34	2.05	1.76	1.47	1.18	1.04	0.90	0.75	0.61	0.46	0.32

DEPTH OF CUT

RECOMMENDED NUMBER OF PASSES

No.OF PASSES	UN EXTERNAL (TPI)			UN INTERNAL (TPI)			WHITWORTH EXTERNAL & INTERNAL (TPI)			BSPT EXTERNAL & INTERNAL (TPI)		
	20	16	12	20	16	12	19	14	11	19	14	11
1	0.20	0.22	0.25	0.19	0.21	0.24	0.22	0.24	0.26	0.19	0.19	0.22
2	0.16	0.20	0.23	0.16	0.19	0.21	0.19	0.21	0.23	0.18	0.18	0.21
3	0.15	0.18	0.20	0.14	0.17	0.19	0.17	0.17	0.20	0.17	0.17	0.20
4	0.13	0.14	0.18	0.11	0.13	0.17	0.14	0.15	0.18	0.15	0.16	0.19
5	0.11	0.11	0.16	0.10	0.10	0.15	0.11	0.14	0.17	0.13	0.15	0.18
6	0.06	0.09	0.14	0.06	0.09	0.13	0.06	0.12	0.16	0.08	0.15	0.16
7		0.06	0.11		0.06	0.10		0.10	0.13		0.12	0.15
8			0.06			0.06		0.06	0.12		0.08	0.13
9									0.06			0.08
Total	0.81	1.00	1.33	0.76	0.95	1.25	0.89	1.19	1.51	0.90	1.20	1.51

DEPTH OF CUT

No. OF PASSES	NPT EXTERNAL & INTERNAL (TPI)				TRAPEZOIDAL EXTERNAL & INTERNAL (MM)	
	18	14	11.5	8	4.0	3.00
1	0.18	0.22	0.23	0.32	0.24	0.20
2	0.15	0.18	0.19	0.25	0.23	0.19
3	0.13	0.15	0.17	0.21	0.22	0.18
4	0.13	0.14	0.16	0.17	0.22	0.18
5	0.12	0.13	0.15	0.16	0.21	0.17
6	0.11	0.12	0.13	0.16	0.20	0.17
7	0.09	0.10	0.12	0.15	0.19	0.16
8	0.08	0.10	0.10	0.15	0.18	0.15
9	0.06	0.09	0.10	0.14	0.17	0.14
10		0.08	0.10	0.13	0.16	0.13
11		0.06	0.09	0.13	0.14	0.11
12			0.08	0.12	0.13	0.08
13			0.06	0.12	0.08	
14				0.10		
15				0.08		
16				0.06		
Total	1.05	1.37	1.68	2.45	2.37	1.86

DEPTH OF CUT

Material Group	Lamina Gr. N°	Material Examples	Hardness	V _c [m/min]	
				min	max
Non Alloyed	1	C35, Ck45, 1020, 1045, 1060, 28Mn6	125 HB	80	130
			190 HB	70	110
			250 HB	60	100
Low Alloyed	2	42CrMo4, St50, Ck60, 4140, 4340, 100Cr6	180 HB	70	110
			230 HB		
			280 HB	60	100
			350 HB	50	80
High Alloyed	3	X40CrMoV5, H13, M42, D3, S6-5-2, 12Ni19	220 HB	70	110
			280 HB	60	100
			320 HB	50	80
			350 HB		70
Austenitic	4	304, 316, X5CrNi18-9	180 HB	70	110
			240 HB	60	90
M Duplex	5	X2CrNiN23-4, S31500	290 HB	60	80
			310 HB		
Ferritic & Martensitic	6	410, X6Cr17, 17-4PH, 430	200 HB	70	90
			42 HRc	60	80
Grey	7	GG20, GG40, EN-GJL-250, N030B	150 HB	60	110
			200 HB	70	110
			250 HB	60	90
Malleable & Nodular	8	GGG40, GGG70, 50005	150 HB	60	110
			200 HB		90
			250 HB		90
Fe, Ni & Co based	9	Incoloy 800	240 HB	40	60
		Inconel 700	250 HB	30	50
		Stellite 21	350 HB	20	40
Ti based	10	T40	-	40	70
		TiAl6V4	-	25	50
Steel	11	X100 CrMo13, 440C, G-X260NiCr42	45 HRc	30	50
			50 HRc		
			55 HRc		
			Chilled Cast Iron	Ni-Hard 2	400 HB
White Cast Iron	G-X300CrMo15	55 HRc			
	NF Aluminium	12	AlSi12	130 HB	80

RECOMMENDED TOOL FEED

Material Group	Lamina Gr. N°	Material Examples	Hardness	Feed (mm/tooth)				
				1.5 - 3.0	3.0 - 5.0	5.0 - 7.0	7.0 - 9.0	9.0 - 11.0
P Non Alloyed Low Alloyed High Alloyed	1	C35, Ck45, 1020, 1045, 1060, 28Mn6	125 HB	0.03	0.04	0.06	0.07	0.09
			190 HB	0.02	0.03	0.05	0.06	0.07
			250 HB					
	2	42CrMo4, St50, Ck60, 4140, 4340, 100Cr6	180 HB	0.02	0.03	0.05	0.06	0.07
			230 HB					
			280 HB					
			350 HB					
	3	X40CrMoV5, H13, M42, D3, S6-5-2, 12Ni19	220 HB	0.02	0.03	0.05	0.06	0.07
			280 HB					
320 HB								
350 HB								
Austenitic	4	304, 316, X5CrNi18-9	180 HB	0.02	0.02	0.03	0.04	0.05
			240 HB			0.02	0.06	0.04
M Duplex	5	X2CrNiN23-4, S31500	290 HB	0.02	0.02	0.02	0.03	0.04
			310 HB	0.015				
Ferritic & Martensitic	6	410, X6Cr17, 17-4PH, 430	200 HB	0.02	0.02	0.02	0.03	0.04
			42 HRc	0.015				
K Grey Malleable & Nodular	7	GG20, GG40, EN- GJL-250, N030B	150 HB	0.02	0.03	0.06	0.07	0.08
			200 HB			0.05	0.06	0.07
			250 HB					
	8	GGG40, GGG70, 50005	150 HB	0.02	0.03	0.06	0.07	0.08
			200 HB			0.05	0.06	0.07
			250 HB					
S Fe, Ni & Co based Ti based	9	Incoloy 800	240 HB	0.02	0.02	0.02	0.03	0.04
		Inconel 700	250 HB	0.015	0.015	0.015	0.02	0.02
		Stellite 21	350 HB	0.01	0.01	0.01	0.015	0.015
	10	TiAl6V4	-	0.02	0.02	0.02	0.02	0.025
		T40	-					0.02
H Steel Chilled Cast Iron White Cast Iron	11	X100 CrMo13, 440C, G-X260NiCr42	45 HRc	0.01	0.01	0.02	0.02	0.02
			50 HRc					
			55 HRc					
			400 HB					
		Ni-Hard 2	400 HB					
		G-X300CrMo15	55 HRc					
NF Aluminium	12	AlSi12	130 HB	0.03	0.03	0.04	0.08	0.12

MACHINING CONDITIONS

DRILLING

MACHINING CONDITIONS - DRILLING - CUTTING SPEED (Vc)

LT 30
LT 3130

Material Group	Lamina Gr. N°	Material Examples	Hardness	LT 30 V _c [m/min]		LT 3130 V _c [m/min]			
				min	max	min	max		
P Non Alloyed Low Alloyed High Alloyed	1	C35, Ck45, 1020, 1045, 1060, 28Mn6	125 HB	180	270	198	297		
			190 HB		230		253		
			250 HB		200		220		
	2	42CrMo4, St50, Ck60, 4140, 4340, 100Cr6	180 HB	120	230	132	253		
			230 HB		190		209		
			280 HB		170		187		
			350 HB		150		165		
	3	X40CrMoV5, H13, M42, D3, S6-5-2, 12Ni19	220 HB	70	170	77	187		
			280 HB		150		165		
320 HB			130		143				
4	304, 316, X5CrNi18-9	180 HB	170	230	187	253			
		240 HB		120		231			
		5		X2CrNiN23-4, S31500		290 HB	70	120	77
310 HB	120		132						
6	410, X6Cr17, 17-4PH, 430	200 HB	100	150	110	165			
		42 HRc		60		100	66	110	
K Grey Malleable & Nodular	7	GG20, GG40, EN-GJL-250, N030B	150 HB	150	230	165	253		
			200 HB		210		231		
			250 HB		170		187		
	8	GGG40, GGG70, 50005	150 HB	120	200	132	220		
			200 HB		170		187		
250 HB	150	165							
S Fe, Ni & Co based Ti based	9	Incoloy 800	240 HB	30	40	27.5	38.5		
		Inconel 700	250 HB		20		40	25.3	38.5
		Stellite 21	350 HB						
10	T40	-	40	60	38.5	66			
	TiAl6V4	-	30	40	30.8	44			
H Steel Chilled Cast Iron White Cast Iron	11	X100CrMo13, 440C, G-X260NiCr42	45 HRc	50	90	55	99		
			50 HRc	40	70	44	77		
			55 HRc	30	60	33	66		
		Ni-Hard 2	400 HB	40	60	40	66		
G-X300CrMo15	55 HRc	30	50	33	55				
NF Aluminium	12	AlSi12	130 HB	200	400	220	440		

MACHINING CONDITIONS - DRILLING - DEPTH OF CUT AND FEED

FOR DRILLING BODIES 2 X D AND 3 X D

SPMG 050204 NN
SPMG 060204 NN
SPMG 07T308 NN

SPMG 090408 NN
SPMG 110408 NN

Material Group	Lamina Gr. N°	Material Examples	Hardness	SPMG 050204 NN		SPMG 060204 NN		SPMG 07T308 NN		SPMG 090408 NN		SPMG 110408 NN	
				Feed [mm/z] min	max	min	max	min	max	min	max	min	max
P Non Alloyed Low Alloyed High Alloyed	1	C35, Ck45, 1020, 1045, 1060, 28Mn6	125 HB	0.04	0.12	0.04	0.15	0.06	0.18	0.06	0.22	0.06	0.24
			190 HB										
			250 HB										
	2	42CrMo4, St50, Ck60, 4140, 4340, 100Cr6	180 HB	0.06	0.12	0.06	0.14	0.08	0.18	0.10	0.22	0.12	0.24
			230 HB										
			280 HB										
			350 HB										
	3	X40CrMoV5, H13, M42, D3, S6-5-2, 12Ni19	220 HB	0.06	0.10	0.06	0.08	0.08	0.12	0.08	0.14	0.10	0.16
			280 HB										
320 HB													
4	304, 316, X5CrNi18-9	180 HB	0.04	0.10	0.04	0.12	0.06	0.14	0.08	0.16	0.10	0.18	
		240 HB											
		290 HB											
5	X2CrNiN23-4, S31500	290 HB	0.05	0.09	0.05	0.10	0.06	0.12	0.06	0.14	0.08	0.15	
		310 HB											
6	410, X6Cr17, 17-4PH, 430	200 HB	0.05	0.09	0.05	0.10	0.06	0.12	0.06	0.14	0.08	0.15	
		42 HRc											
7	GG20, GG40, EN-GJL-250, N030B	150 HB	0.06	0.12	0.06	0.14	0.08	0.16	0.10	0.20	0.12	0.24	
		200 HB											
		250 HB											
8	GGG40, GGG70, 50005	150 HB	0.06	0.12	0.06	0.14	0.08	0.16	0.10	0.20	0.12	0.24	
		200 HB											
		250 HB											
9	Incoloy 800	240 HB	0.05	0.08	0.05	0.08	0.06	0.09	0.06	0.09	0.06	0.10	
		Inconel 700											
		Stellite 21											
10	TiAl6V4	-	0.05	0.08	0.05	0.08	0.06	0.09	0.06	0.09	0.06	0.10	
	T40												
H Steel Chilled Cast Iron White Cast Iron	11	X100CrMo13, 440C, G-X260NiCr42	45 HRc	0.04	0.07	0.04	0.07	0.05	0.08	0.06	0.09	0.06	0.09
			50 HRc										
			55 HRc										
		Ni-Hard 2	400 HB										
G-X300CrMo15	55 HRc												
NF Aluminium	12	AlSi12	130 HB	0.05	0.12	0.05	0.14	0.06	0.16	0.06	0.18	0.08	0.20

MACHINING CONDITIONS - DRILLING - DEPTH OF CUT AND FEED

MACHINING CONDITIONS - DRILLING - DEPTH OF CUT AND FEED

FOR DRILLING BODIES 4 X D

SPMG 050204 NN
SPMG 060204 NN
SPMG 07T308 NN

SPMG 090408 NN
SPMG 110408 NN

WCMX 040208 NN
WCMX 050308 NN

WCMX 06T308 NN
WCMX 080412 NN

Material Group	Lamina Gr. N°	Material Examples	Hardness	SPMG 050204 NN		SPMG 060204 NN		SPMG 07T308 NN		SPMG 090408 NN		SPMG 110408 NN	
				Feed [mm/z] min	Feed [mm/z] max	Feed [mm/z] min	Feed [mm/z] max	Feed [mm/z] min	Feed [mm/z] max	Feed [mm/z] min	Feed [mm/z] max	Feed [mm/z] min	Feed [mm/z] max
Non Alloyed	1	C35, Ck45, 1020, 1045, 1060, 28Mn6	125 HB	0.03	0.09	0.03	0.12	0.04	0.14	0.04	0.18	0.06	0.19
			190 HB										
			250 HB										
Low Alloyed	2	42CrMo4, St50, Ck60, 4140, 4340, 100Cr6	180 HB	0.04	0.09	0.04	0.09	0.05	0.15	0.06	0.18	0.09	0.19
			230 HB										
			280 HB										
			350 HB										
High Alloyed	3	X40CrMoV5, H13, M42, D3, S6-5-2, 12Ni19	220 HB	0.04	0.07	0.04	0.07	0.05	0.11	0.06	0.12	0.07	0.13
			280 HB										
			320 HB										
			350 HB										
Austenitic	4	304, 316, X5CrNi18-9	180 HB	0.03	0.08	0.03	0.09	0.03	0.11	0.05	0.13	0.07	0.14
			240 HB										
M Duplex	5	X2CrNiN23-4, S31500	290 HB	0.03	0.09	0.03	0.07	0.03	0.10	0.04	0.11	0.05	0.13
			310 HB										
Ferritic & Martensitic	6	410, X6Cr17, 17-4PH, 430	200 HB	0.03	0.07	0.03	0.07	0.04	0.10	0.05	0.12	0.05	0.13
			42 HRc										
Grey	7	GG20, GG40, EN-GJL-250, N030B	150 HB	0.04	0.10	0.04	0.12	0.05	0.13	0.06	0.17	0.08	0.20
			200 HB										
			250 HB										
Malleable & Nodular	8	GGG40, GGG70, 50005	150 HB	0.04	0.09	0.04	0.11	0.05	0.12	0.08	0.16	0.08	0.19
			200 HB										
			250 HB										
Fe, Ni & Co based	9	Incoloy 800, Inconel 700, Stellite 21	240 HB	0.03	0.06	0.03	0.07	0.03	0.08	0.04	0.09	0.05	0.10
			250 HB										
			350 HB										
Ti based	10	TiAl6V4, T40	-	0.03	0.06	0.03	0.07	0.03	0.08	0.04	0.09	0.05	0.10
			-										
Steel	11	X100 CrMo13, 440C, G-X260NiCr42	45 HRc	0.03	0.06	0.03	0.06	0.03	0.07	0.04	0.08	0.05	0.09
			50 HRc										
			55 HRc										
			400 HB										
Chilled Cast Iron		Ni-Hard 2	400 HB										
			400 HB										
White Cast Iron		G-X300CrMo15	55 HRc										
			55 HRc										
NF Aluminium	12	AlSi12	130 HB	0.03	0.10	0.04	0.12	0.05	0.14	0.06	0.15	0.07	0.16

Material Group	Lamina Gr. N°	Material Examples	Hardness	WCMX 040208 NN		WCMX 050308 NN		WCMX 06T308 NN		WCMX 080412 NN	
				Feed [mm/z] min	Feed [mm/z] max	Feed [mm/z] min	Feed [mm/z] max	Feed [mm/z] min	Feed [mm/z] max	Feed [mm/z] min	Feed [mm/z] max
Non Alloyed	1	C35, Ck45, 1020, 1045, 1060, 28Mn6	125 HB	0.05	0.10	0.06	0.11	0.06	0.12	0.06	0.16
			190 HB								
			250 HB								
Low Alloyed	2	42CrMo4, St50, Ck60, 4140, 4340, 100Cr6	180 HB	0.05	0.10	0.06	0.11	0.06	0.12	0.06	0.16
			230 HB								
			280 HB								
			350 HB								
High Alloyed	3	X40CrMoV5, H13, M42, D3, S6-5-2, 12Ni19	220 HB	0.07	0.10	0.09	0.11	0.08	0.12	0.09	0.16
			280 HB								
			320 HB								
			350 HB								
Austenitic	4	304, 316, X5CrNi18-9	180 HB	0.05	0.10	0.06	0.11	0.06	0.12	0.06	0.15
			240 HB								
M Duplex	5	X2CrNiN23-4, S31500	290 HB	0.07	0.09	0.09	0.10	0.08	0.11	0.09	0.14
			310 HB								
Ferritic & Martensitic	6	410, X6Cr17, 17-4PH, 430	200 HB	0.07	0.09	0.09	0.10	0.08	0.11	0.09	0.14
			42 HRc								
Grey	7	GG20, GG40, EN-GJL-250, N030B	150 HB	0.09	0.11	0.09	0.12	0.09	0.13	0.10	0.18
			200 HB								
			250 HB								
Malleable & Nodular	8	GGG40, GGG70, 50005	150 HB	0.09	0.11	0.09	0.12	0.09	0.13	0.10	0.18
			200 HB								
			250 HB								
Fe, Ni & Co based	9	Incoloy 800, Inconel 700, Stellite 21	240 HB	0.05	0.08	0.06	0.09	0.06	0.10	0.06	0.13
			250 HB								
			350 HB								
Ti based	10	TiAl6V4, T40	-	0.05	0.08	0.06	0.09	0.06	0.10	0.06	0.13
			-								
Steel	11	X100 CrMo13, 440C, G-X260NiCr42	45 HRc	0.05	0.08	0.06	0.09	0.06	0.10	0.06	0.13
			50 HRc								
			55 HRc								
			400 HB								
Chilled Cast Iron		Ni-Hard 2	400 HB								
			400 HB								
White Cast Iron		G-X300CrMo15	55 HRc								
			55 HRc								
NF Aluminium	12	AlSi12	130 HB	0.05	0.10	0.06	0.11	0.10	0.12	0.10	0.16

* For drilling 4xD the feed must be reduced by 50%

Increase your production efficiency



TECHNICAL GUIDE

MACHINING OPTIMIZATION	352
MATERIAL GROUPS	355
MACHINING RECOMMENDATIONS	356
COOLANT GUIDE	357
TECHNICAL FORMULAS	358
SPECIFIC CUTTING FORCES	359
THREAD TURNING	360
HIGH FEED MILLING	366
LT 752 & LT 910 MILLING CUTTER LINES	367
ASSEMBLING INSTRUCTIONS - LT 752 & LT 910	368
COPY MILLING	369
DRILLING COOLANT	370
TROUBLESHOOTING	372
HELICAL INTERPOLATION	374

MACHINING OPTIMIZATION

For new users of Lamina Technologies MULTI-MAT™ (MULTI-MATeRIal) inserts and to get more productivity and longer tool life, we have prepared a short machining guide to insure your satisfaction with our products.

The machining conditions included after each insert are our guidelines for optimal machining. However, our inserts can work in a range of cutting conditions to meet special machining needs.



TURNING



Check the condition of the tool holder (insert seat, shim, lever, screw) and check if the insert is well seated and clamped.

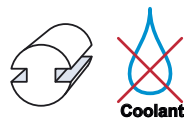

If there are interrupted cut or passes with short lengths of cut, dry operation is recommended to avoid thermal shocks. For heavy interrupted cut feed rate should be reduced.



Check the stability of the machine. The tool overhang should be as short as possible.

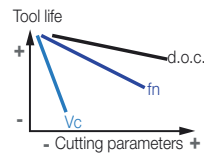

Cutting speed has the greatest influence on tool life. For high productivity and long tool life, first increase d.o.c. and feed rate.

$$\text{Feed} \times \text{d.o.c.} = \text{Amax}$$

Respect maximum chip section area for each insert. $A_{max} = \text{feed} \times \text{d.o.c.}$

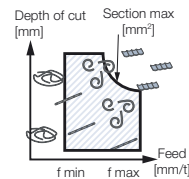

For higher productivity and better chip control in roughing, work close to the recommended A_{max} value.

MILLING

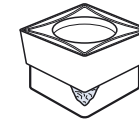

Check the condition of the tool holder (insert seat, shim, lever, screw) and check if the insert is well seated and clamped.



Check the stability of the machine. The tool overhang should be as short as possible.

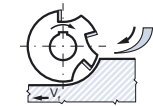

Climb Milling
Usually this is the recommended direction. Tool life up to 40% longer than conventional.

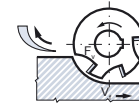

Conventional Milling

Recommended only for:

- Old machines with backlash in the table transmission
- Flame cut, forged and cast workpieces
- Thin workpieces (in order to reduce vibration)

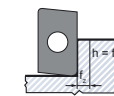

K = 90° Approach angle
High radial forces / Low axial forces.

Recommended:

- When 90° wall is needed
- For slender workpieces

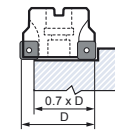

For face milling the width of cut (ae) should be about 70% of the cutter diameter, in order to achieve better chip formation and longer tool life. For limited engagement conditions, it is necessary to increase feed per tooth.

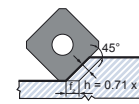

K = 45° Approach angle
identical radial and axial forces.
High productivity $fz = 1.41 \times h$

Recommended:





- When overhang is long (lower vibration tendency)
- For face milling (1st choice)

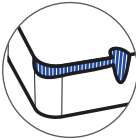
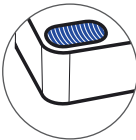
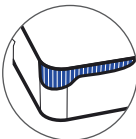

Round Inserts:
Roughing and general purposes.
Strongest cutting edge.

MACHINING OPTIMIZATION

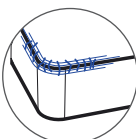
MATERIAL GROUPS

	<p>BUILT-UP EDGE (Adhesive Wear)</p> <p>Description The workpiece material is welded to the cutting edge. Normally caused by low temperatures</p> <p>Solutions Increase cutting speed / Increase feed / Use more positive geometry</p>
	<p>NOTCH WEAR (Adhesive/Mechanic Wear)</p> <p>Description Result of adhesive or mechanical action. Chipping or localized wear at the depth of cut line.</p> <p>Solutions Use more positive geometry / Reduce feed / Vary depth of cut</p>
	<p>CRATER (Chemical Wear)</p> <p>Description Happens on the rake surface. Normally the result of a combination of a diffusion and abrasion wear mechanism.</p> <p>Solutions Decrease cutting speed / Check coolant direction / Use more positive geometry</p>
	<p>FLANK WEAR (Abrasive Wear)</p> <p>Description Abrasive wear mechanism that happens on the cutting edge's flank. Not common in Lamina inserts.</p> <p>Solutions Decrease cutting speed / Check coolant direction.</p>
	<p>PLASTIC DEFORMATION (Thermal Wear)</p> <p>Description Caused by cutting forces and too high temperature. Not common in Lamina inserts.</p> <p>Solutions Decrease cutting speed / Decrease feed rate</p>
	<p>THERMAL CRACKS (Thermal Wear)</p> <p>Description Small cracks normally at 90° to the cutting edge caused by temperature variation.</p> <p>Solutions Stabilize the temperature / Shut off the coolant</p>
	<p>BREAKAGE (Mechanic Wear)</p> <p>Description Most breakages happen because the wear development is not seen in time.</p> <p>Solutions Check the tool holder / Check the tool overhang / Check the Amax / Decrease feed and Vc / Apply more robust insert / Check the run-out</p>

MATERIAL GROUP	LAMINA GR. N°	VDI GRP	MATERIAL EXAMPLES	DESCRIPTION	CAUTION	
Non Alloyed P High Alloyed	1	1	C35, Ck45, 1020, 1045, 1060, 28Mn6	Non-alloyed Steel Composition: Fe-C alloy (usually 0.1 to 0.6% carbon). Characteristics: Good machinability and high cutting speeds can be applied. When it has less than 0.25% carbon, it can be very sticky, requiring positive rake and small land inserts.	Built-up edge Crater	
		2				
		3				
	2	4, 6	42CrMo4, St50, Ck60, 4140, 4340, 100Cr6		Alloyed Steel Composition: Fe-C alloy (maximum 2.1% carbon) with additives like Cr, Mo, V, Ni, Mn, Co, W, etc. Characteristics: The variation in the amount of alloying elements and different heat treatments control features such as mechanical resistance and machinability. It's important to follow the cutting speeds recommended according to the hardness of the steel, as it influences temperature as well as chemical and adhesive wears. High alloyed Steel have more than 5% alloying elements.	Built-up edge Crater
		5, 7				
		6				
		8				
	3	10	X40CrMoV5, H13, M42, D3, S6-5-2, 12Ni19			
		10				
		11				
		11				
Austenitic	4	14	304, 316, X5CrNi18-9	Composition: Alloyed steel, more than 11% chrome (Cr). Characteristics: Stainless steels do not stain, corrode, or rust as easily as ordinary steel. Usually they are difficult to machine because of its narrow range of cutting speeds. If the cutting speed is too low, the material sticks in the cutting edge, if it's too high, the high quantity of additives produces abrasive wears in the cutting edge.		Built-up edge Notch wear
		14				
M Duplex	5	14	X2CrNiN23-4, S31500	Characteristics: Stainless steels do not stain, corrode, or rust as easily as ordinary steel. Usually they are difficult to machine because of its narrow range of cutting speeds. If the cutting speed is too low, the material sticks in the cutting edge, if it's too high, the high quantity of additives produces abrasive wears in the cutting edge.		Notch wear Crater
		14				
Ferritic & Martensitic	6	12	410, X6Cr17, 17-4PH, 430	Composition: Fe-C alloy with 2.1 to 5% of carbon. It can be alloyed with Si, P, Mn and Ni. Characteristics: Grey cast iron tends to be brittle, and malleable cast irons usually have a more ductile but less homogeneous micro-structure. Reinforced cutting edges will perform best. High productivity can be achieved by using high feeds.	Crater	
		13				
Grey K Malleable & Nodular	7	15	GG20, GG40, EN-GJL-250, N030B	Composition: Fe-C alloy with 2.1 to 5% of carbon. It can be alloyed with Si, P, Mn and Ni. Characteristics: Grey cast iron tends to be brittle, and malleable cast irons usually have a more ductile but less homogeneous micro-structure. Reinforced cutting edges will perform best. High productivity can be achieved by using high feeds.	Flank wear Crater Mechanical cracks	
		15				
Fe, Ni & Co based S Ti based	9	17, 19	GG40, GG70, 50005	Composition: Iron (Fe) based, Nickel (Ni) based or Cobalt (Co) based alloys and Titanium alloys. Characteristics: High temperature alloys and titanium provide excellent mechanical strength resistance, as well as corrosion and oxidation resistance. Relatively low cutting speed is recommended due to their poor thermal conductivity.	Notch wear Crater	
		18, 20				
Steel H Chilled Cast Iron White Cast Iron	11	31, 32	Incoloy 800	Composition: Iron (Fe) based, Nickel (Ni) based or Cobalt (Co) based alloys and Titanium alloys. Characteristics: High temperature alloys and titanium provide excellent mechanical strength resistance, as well as corrosion and oxidation resistance. Relatively low cutting speed is recommended due to their poor thermal conductivity.	Notch wear Crater	
		33				
Alu AL (<8%Si) NF Copper Alloys Non Metallic	14	34	TiAl6V4	Composition: Iron (Fe) based, Nickel (Ni) based or Cobalt (Co) based alloys and Titanium alloys. Characteristics: High temperature alloys and titanium provide excellent mechanical strength resistance, as well as corrosion and oxidation resistance. Relatively low cutting speed is recommended due to their poor thermal conductivity.	Notch wear Crater	
		36				
Steel H Chilled Cast Iron White Cast Iron	11	37	T40	Composition: Iron (Fe) based, Nickel (Ni) based or Cobalt (Co) based alloys and Titanium alloys. Characteristics: High temperature alloys and titanium provide excellent mechanical strength resistance, as well as corrosion and oxidation resistance. Relatively low cutting speed is recommended due to their poor thermal conductivity.	Notch wear Crater	
		37				
Alu AL (<8%Si) NF Copper Alloys Non Metallic	15	38	X100 CrMo13, 440C, G-X260NiCr42	Composition: Iron (Fe) based, Nickel (Ni) based or Cobalt (Co) based alloys and Titanium alloys. Characteristics: High temperature alloys and titanium provide excellent mechanical strength resistance, as well as corrosion and oxidation resistance. Relatively low cutting speed is recommended due to their poor thermal conductivity.	Notch wear Crater	
		38				
Alu AL (<8%Si) NF Copper Alloys Non Metallic	14	25	AlSi12	Composition: Iron (Fe) based, Nickel (Ni) based or Cobalt (Co) based alloys and Titanium alloys. Characteristics: High temperature alloys and titanium provide excellent mechanical strength resistance, as well as corrosion and oxidation resistance. Relatively low cutting speed is recommended due to their poor thermal conductivity.	Notch wear Crater	
		25				
Alu AL (<8%Si) NF Copper Alloys Non Metallic	15	21, 22, 23, 24	4% < Si < 8% Si < 4%	Composition: Iron (Fe) based, Nickel (Ni) based or Cobalt (Co) based alloys and Titanium alloys. Characteristics: High temperature alloys and titanium provide excellent mechanical strength resistance, as well as corrosion and oxidation resistance. Relatively low cutting speed is recommended due to their poor thermal conductivity.	Notch wear Crater	
		21, 22, 23, 24				
Alu AL (<8%Si) NF Copper Alloys Non Metallic	16	26, 27, 28	CuZn30	Composition: Iron (Fe) based, Nickel (Ni) based or Cobalt (Co) based alloys and Titanium alloys. Characteristics: High temperature alloys and titanium provide excellent mechanical strength resistance, as well as corrosion and oxidation resistance. Relatively low cutting speed is recommended due to their poor thermal conductivity.	Notch wear Crater	
		26, 27, 28				
Alu AL (<8%Si) NF Copper Alloys Non Metallic	17	29	Fiber Plastics	Composition: Iron (Fe) based, Nickel (Ni) based or Cobalt (Co) based alloys and Titanium alloys. Characteristics: High temperature alloys and titanium provide excellent mechanical strength resistance, as well as corrosion and oxidation resistance. Relatively low cutting speed is recommended due to their poor thermal conductivity.	Notch wear Crater	
		29				
Alu AL (<8%Si) NF Copper Alloys Non Metallic	17	-	Graphite	Composition: Iron (Fe) based, Nickel (Ni) based or Cobalt (Co) based alloys and Titanium alloys. Characteristics: High temperature alloys and titanium provide excellent mechanical strength resistance, as well as corrosion and oxidation resistance. Relatively low cutting speed is recommended due to their poor thermal conductivity.	Notch wear Crater	
		-				
Alu AL (<8%Si) NF Copper Alloys Non Metallic	17	30	Hard Rubber	Composition: Iron (Fe) based, Nickel (Ni) based or Cobalt (Co) based alloys and Titanium alloys. Characteristics: High temperature alloys and titanium provide excellent mechanical strength resistance, as well as corrosion and oxidation resistance. Relatively low cutting speed is recommended due to their poor thermal conductivity.	Notch wear Crater	
		30				

MACHINING RECOMMENDATIONS

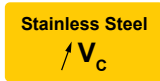

In machining stainless steel, please verify and respect the cutting speed recommended for the insert as there is a tendency to machine at speeds that are too low.



In machining stainless steel or exotic materials, P geometry inserts (CNMP, TNMP, WNMP) and NX chipbreakers are recommended as first choice.



In machining exotic materials, it is important to verify cutting conditions of the specific insert.

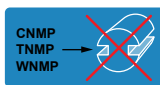

P geometry inserts (CNMP, TNMP, WNMP) are not recommended when machining with interrupted cut.

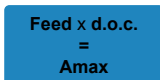

It is important to verify and respect Amax, which is the maximum chip section. Feed x d.o.c. must be lower than the number noted as Amax.

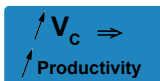

To increase machining productivity, it is recommended to increase speed (Vc) while respecting chip size calculation.

COOLANT GUIDE

SUCCESSFUL MACHINING OPERATIONS DEPEND ON CORRECT COOLANT APPLICATION

TURNING

- In continuous cut, the application of coolant is recommended for all workpiece materials.
- If there is interrupted cut, use dry operation when machining material groups P, M, K and H.
- Coolant is always recommended for High-Temp Alloys (Group S) and Aluminum (Group N).

MILLING

- In dry operations, the usage of "air blow" is always recommended in order to evacuate the chips which can accumulate causing tool breakage and problems with surface finishing.

DRILLING

- Coolant in drilling is always recommended independent of workpiece material as it helps chip evacuation, improves hole quality and increases tool life.

MATERIAL GROUP	TURNING		MILLING	DRILLING
	STABLE CUT	INTERRUPTED CUT		
P				
M				
K				
S				
H				
N				

• When machining Duplex Stainless Steels, both wet and dry operations should be considered, depending on variables in the machining process.

TECHNICAL FORMULAS

Turning

Cutting Speed (m/min)	$V_c = \frac{D_m \times \pi \times n}{1000}$
Rotation (Rev/min)	$n = \frac{V_c \times 1000}{D_m \times \pi}$
Chip Removal Rate (cm³/min)	$Q = V_c \times a_p \times f_n$
Cutting Time (min)	$T_c = \frac{l_m}{f_n \times n}$
Surface Roughness (µm)	$R_{max} = \frac{f_n^2}{r_\epsilon} \times 125$

Symbol	Designation	Unit
D_m	Machining diameter	mm
f_n	Feed per revolution	mm/rev
l_m	Machining length	mm
n	Rotation	rev/min
Q	Chip removal rate	cm ³ /min
A_{max}	d.o.c x feed	mm ²
r_ε	Nose radius	mm
T_c	Cutting time	min
R_{max}	Surface roughness	µm

Milling

Cutting Speed (m/min)	$V_c = \frac{n \times \pi \times D}{1000}$
Rotation (Rev/min)	$n = \frac{V_c \times 1000}{\pi \times D}$
Table Feed (mm/min)	$V_f = n \times z_c \times f_z$
Cutting Output (cm³/min)	$Q = \frac{a_e \times a_p \times V_f}{1000}$
Feed per Tooth	$f_z = \frac{V_f}{n \times z_c}$

Symbol	Designation	Unit
V_c	Cutting speed	m/min
a_p	Depth of cut (d.o.c.)	mm
a_e	Radial depth of cut (width of cut)	mm
D	Cutter diameter	mm
f_z	Feed per tooth	mm/tooth
Z_c	Effective number of teeth	pcs
V_f	Table Feed	mm/min
Z_n	Total number of teeth	pcs

SPECIFIC CUTTING FORCES

MATERIAL GROUP	Lamina Gr. N°	VDI Grp	MATERIAL EXAMPLES	HARDNESS	Specific cutting force, kc1 (N/mm ²)	m _c		
P	Non-Alloyed	1	C35, CK45, 1020, 1045, 1060, 28MN6	125 HB	1500	0.25		
		2		190 HB	1700	0.25		
		3		250 HB	1850	0.25		
	Low alloyed	2	4	42CRMO4, ST50, CK60, 4140, 4340, 100CR6	180 HB	1700	0.25	
			5.6		230 HB	1800	0.25	
			7.8		280 HB	2040	0.25	
			9		350 HB	2900	0.25	
	High alloyed	3	10	X40CRMOV5, H13, M42, D3, S6-5-2, 12NI19	220 HB	2050	0.25	
			10		280 HB	2600	0.25	
			11		320 HB	2950	0.25	
			11		350 HB	3100	0.25	
M	Austenitic	4	304, 316, X5CRNi18-9	180 HB	1800	0.21		
				240 HB	2100	0.21		
	Duplex	5	X2CRNi23-4, S31500	290 HB	2600	0.21		
Ferritic & Martensitic	6	410, X6CR17, 17-4 PH, 430	310 HB	2800	0.21			
			200 HB	1800	0.21			
K	Grey	7	GG20, GG40, EN-GJL-250, NO30B	42 HRc	2800	0.21		
				15	200 HB	1000	0.28	
				16	250 HB	1100	0.28	
	Malleable & Nodular	8	GGG40, GGG70, 50005	150 HB	870	0.28		
				17.19	200 HB	1150	0.28	
				18.20	250 HB	1400	0.28	
S	Fe, Ni & Co based	9	Incoloy 800	240 HB	2600	0.25		
				33	Inconel 700	250 HB	2700	0.25
				34	Stellite 21	350 HB	-3300	0.25
	Ti bases	10	TIAL6V4	-	1400	0.23		
NF	Al (>8%Si)	12	T40	-	1450	0.23		
				TIAL6V4	130 HB	700	0.25	

NUMBER OF THREADING PASSES SELECTION FOR SINGLE POINTS INSERTS

PITCH	mm TPI	0.5 48	0.8 32	1.0 24	1.25 20	1.5 16	1.75 14	2.0 12	2.5 10	3.0 8	4.0 6	6.0 4
NUMBER OF PASSES		3-6	4-7	4-9	6-10	5-11	9-12	6-13	7-15	8-17	10-20	11-22

NOTES

1. For most standard applications the middle of the range is a good starting point.
2. The tougher workpiece material, the higher the number of cutting passes you should select.
3. General rule of thumb: fewer passes are better than more speed.

THREAD TURNING METHODS

EXTERNAL THREAD

RIGHT THREAD

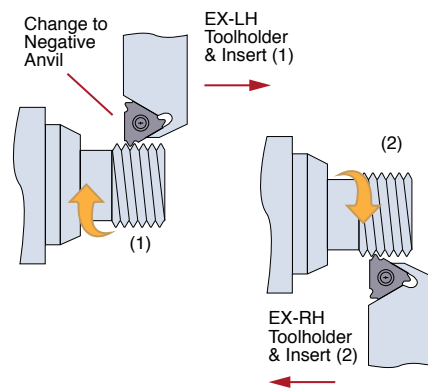

LEFT THREAD

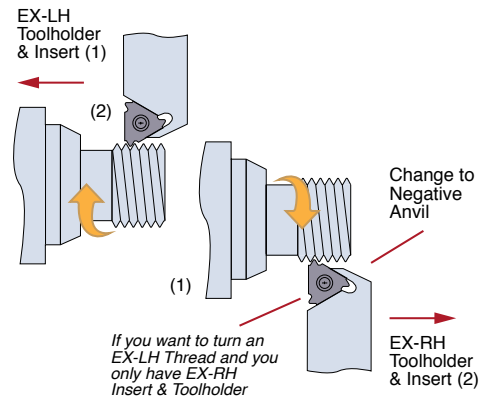

INTERNAL THREAD

RIGHT THREAD

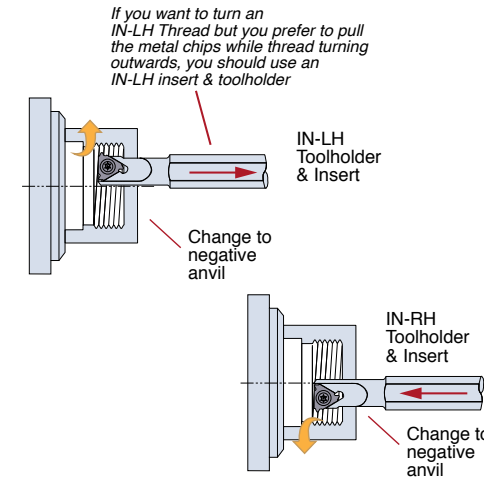

LEFT THREAD

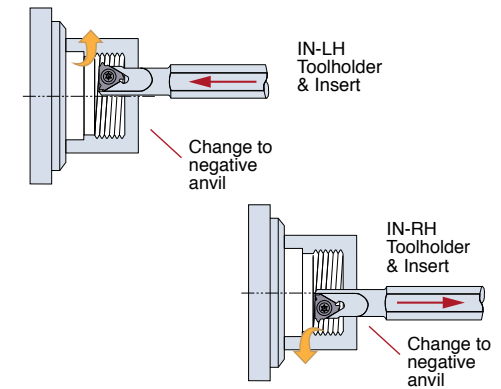

THREADING INSERTS

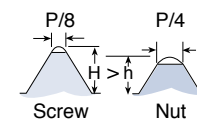

1. In most thread forms internal and external threads have different depth and radius, thus tools are not interchangeable

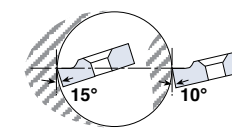

2. The insert relief angle of a standard Lamina external toolholder is 10°; for an internal toolholder it is 15°. This 5° difference is to provide additional necessary radial clearance.

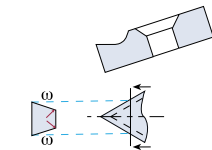

3. Our built-in relief angles ensure automatic insert flank angle clearance.

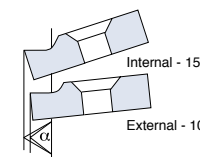

1. Profiles of Lamina internal & external threading inserts are precisely ground to ensure accurate thread geometry when used in their corresponding toolholders. Using internal inserts with an external holder will result in distortion of angle and insert geometry.



2. Insert and toolholder should always match. An IN-RH insert must be used with an IN-RH toolholder.
No mismatch is allowed.

THREAD HELIX ANGLE

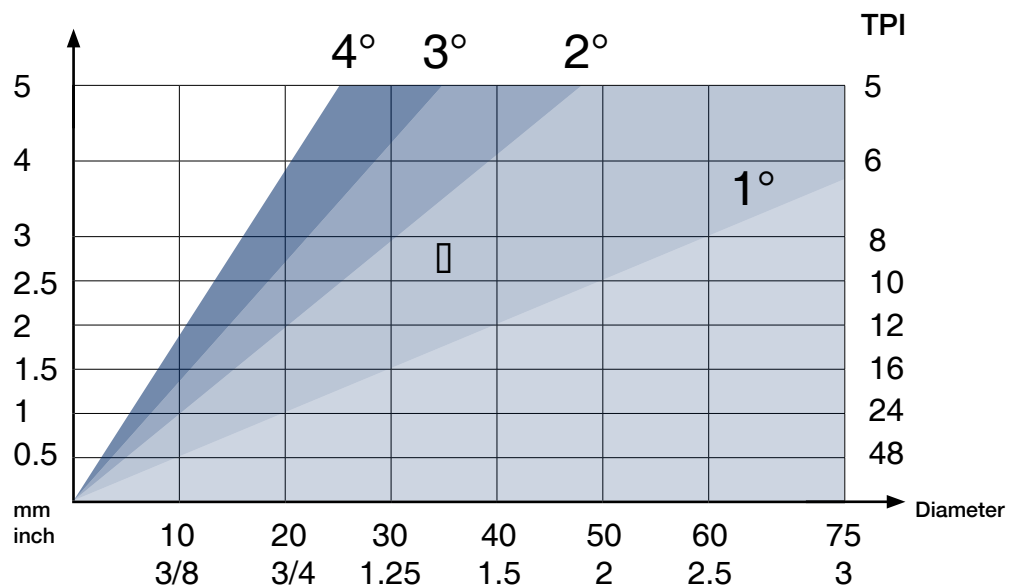

STANDARD AND SLANTED ANVILS

Lamina Toolholder Pockets are built with 1.5° helix angle. This angle may be adjusted to better match the thread helix angle by simply changing the anvil.

Negative helix is usually used when threading RH thread with LH holder or LH thread with RH holder.

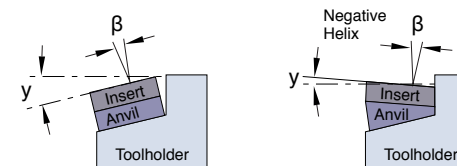

L	IC	POCKET ANGLE Y	4.5°	3.5°	2.5°	1.5° STANDARD	0.5°	-0.5°	-1.5°
16	3/8	EX-RH or IN-LH	SHIM 16E+4.5	SHIM 16E+3.5	SHIM16E+2.5	SHIM 16E	SHIM 16E+0.5	SHIM 16E-0.5	SHIM 16E-1.5
16	3/8	EX-LH or IN-RH	SHIM 16I+4.5	SHIM 16I+3.5	SHIM 16I+2.5	SHIM 16I	SHIM 16I+0.5	SHIM 16I-0.5	SHIM 16I-1.5
22	1/2	EX-RH or IN-LH	SHIM 22E+4.5	SHIM 22E+3.5	SHIM 22E+2.5	SHIM 22E	SHIM 22E+0.5	SHIM 22E-0.5	SHIM 22E-1.5
22	1/2	EX-LH or IN-RH	SHIM 22I+4.5	SHIM 22I+3.5	SHIM 22I+2.5	SHIM 22I	SHIM 22I+0.5	SHIM 22I-0.5	SHIM 22I-1.5

$$\tan \beta = \frac{P}{\pi \times D}$$

Simplified formula

$$\beta = 20P/D$$

Example:

D = 30 mm (1.18")

P = 1.5 mm (16 TPI)

$$\beta = \frac{20 \times 15}{30} = 1^\circ$$

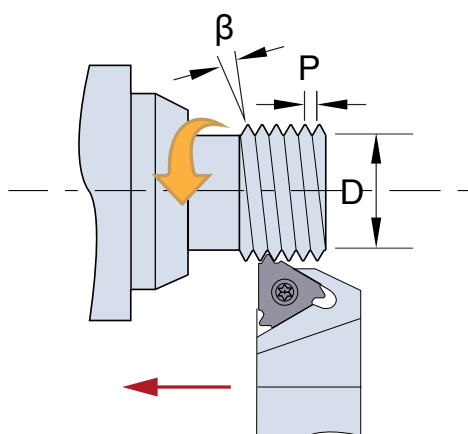

ANVIL CHANGE RECOMMENDATION

As it can be seen on the chart below, some Pitch to Diameter combinations require an anvil change.
 If change is required, use AE anvils for EX-RH and IN-LH toolholders and AI anvils for IN-RH and EX-LH

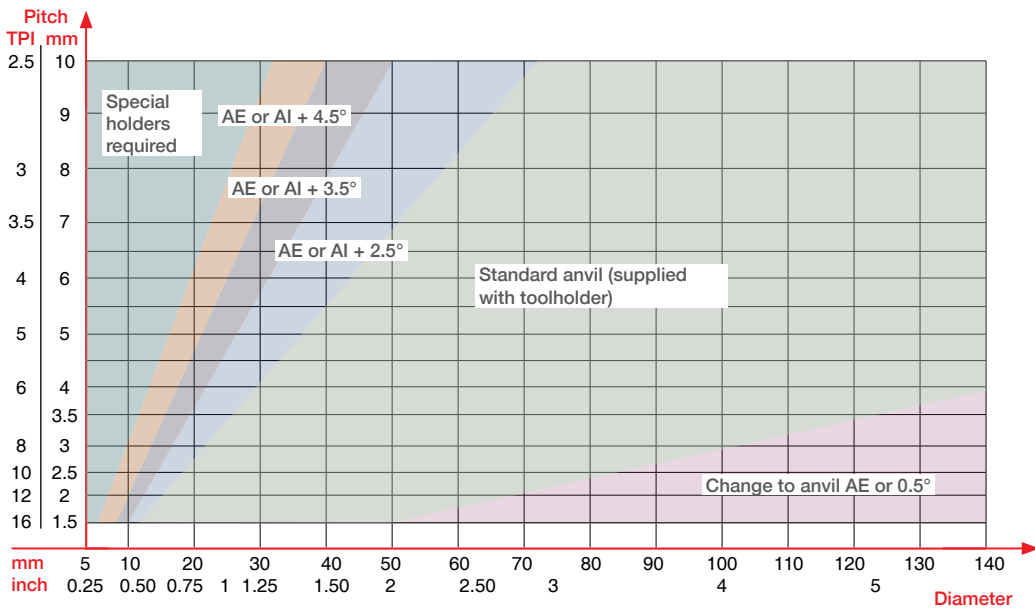

TRAPEZ (DIN 103)

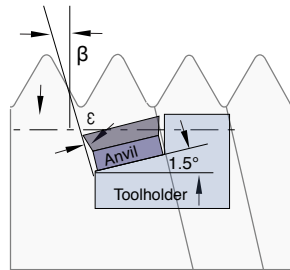

As it can be seen on the chart below, most application do not require an anvil change. If change is required, use AE anvils for EX-RH and IN-LH toolholders and AI anvils for IN-RH and EX-LH

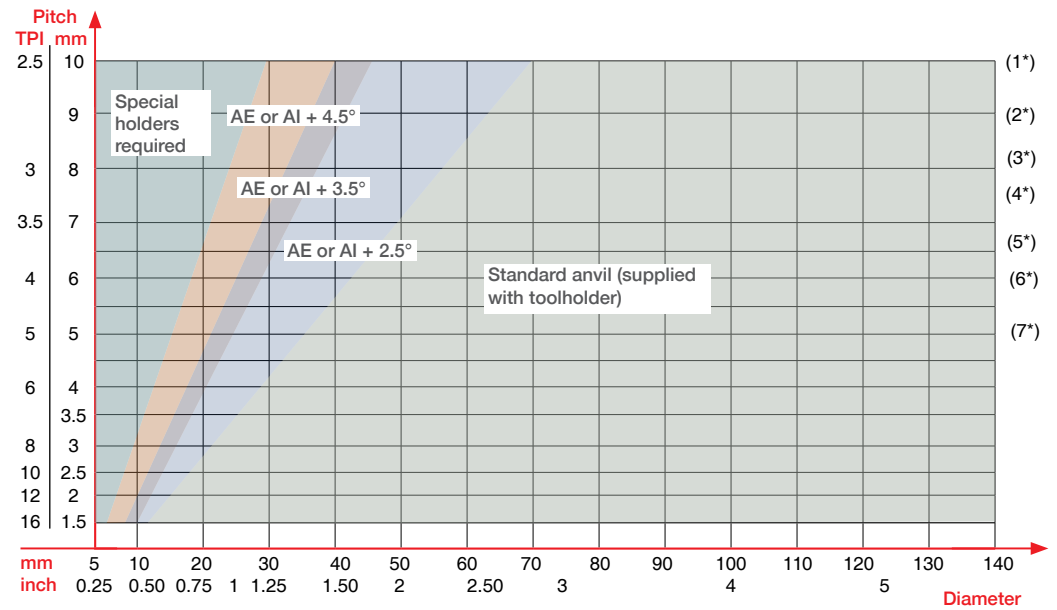

- (1*) PARTIAL PROFILE 60°
- (2*) PARTIAL PROFILE 55°
- (3*) ISO
- (4*) UN
- (5*) WHIT
- (6*) NPT
- (7*) BSPT

HIGH FEED MILLING

EFFECTIVE DIAMETER FOR RPM CALCULATION

The effective cutting diameter (D_{eff}) must be calculated to obtain the correct revolution per minute (RPM) and consequently the table feed.

The effective cutting diameter is calculated using the following values and formula.

$$n = \frac{V_c \times 1000}{D_{eff} \times \pi}$$

$$D_{eff} = D - \ell$$

Symbol	Designation	Unit
D	Cutter Diameter	mm
DOC	Depth of cut	mm
ℓ	Diameter compensation (see chart below)	mm

SDKX 0904-HF SDKW 0904-HF		SDKX 1205-HF SDKW 1205-HF		APKT 0602-HF APKW 0602-HF	
DOC (mm)	ℓ (mm)	DOC (mm)	ℓ (mm)	DOC (mm)	ℓ (mm)
1.5	0	2.0	0	0.5	0
1.4	0.22	1.8	0.66	0.4	0.32
1.3	0.58	1.6	1.58	0.3	0.72
1.2	1.04	1.4	2.58	0.2	1.28
1.1	1.52	1.2	3.66	0.1	2.22
1.0	2.02	1.0	4.84		
0.9	2.54	0.8	6.16		
0.8	3.10	0.6	7.66		
0.7	3.70	0.4	9.44		
0.6	4.34	0.2	11.76		
0.5	5.06				
0.4	5.82				
0.3	6.72				
0.2	7.74				
0.1	9.06				

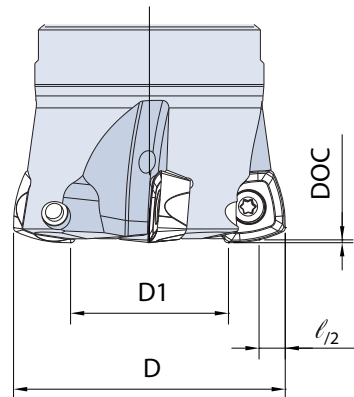

EXAMPLE FOR D_{eff} CALCULATION

Cutter: LT 903 S-W-D040/4 (D=40/Z=4)
 Insert: SDKX 1205-HF
 Material: Lamina Group 3 – 280 HB

VALUES	INCORRECT CALCULATION	CORRECT CALCULATION
Vc = 120 m/min D = 40 mm DOC = 1.0 mm ℓ = 4.84 mm $D_{eff} = D - \ell$ $D_{eff} = 40 - 4.84$ $D_{eff} = 35.16$	RPM for D=40 n = 954 rev/min	RPM for D_{eff} =35.16 n = 1085 rev/min

LT 752 / LT 910 - CUTTER LINE

APPLICATION PARAMETERS

LT 752 - SHOULDER MILLING - APKT 060204-PDTR

D	α° max. for linear ramping	Ap max. for linear ramping	Ae max. for linear plunging	Helical Milling			
				C min.	P max.	C max.	P max.
10	3	5.2	0.6	14	0.9	19	3.0
12	2.2			18		23	2.5
16	1.5			26		31	2.0
20	1.15			34		39	1.8
25	0.9			44		49	1.7
32	0.7			58		63	1.7

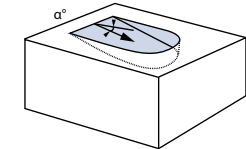

LT 910 - HIGH FEED MILLING - XPKT & XPKW 0602-HF

D	D1*	α° max. for linear ramping	Ap max. for linear ramping	Ae max. for linear plunging	Helical Milling			
					C min.	P max.	C max.	P max.
10	4.7	1.25	0.5	2.4	14.7	0.5	18	0.5
12	6.7	2.5			18.7		22	
16	10.7	2			26.7		30	
20	14.7	1.25			34.7		38	
25	19.7	1			44.7		48	
32	26.7	0.9			58.7		62	

* Flat surface on face milling = D1

PROGRAMMING RADIUS

Uncut Area = Uncut thickness, maximum mismatch between programmed corner radii (R_{prog}) and generated machined profile.

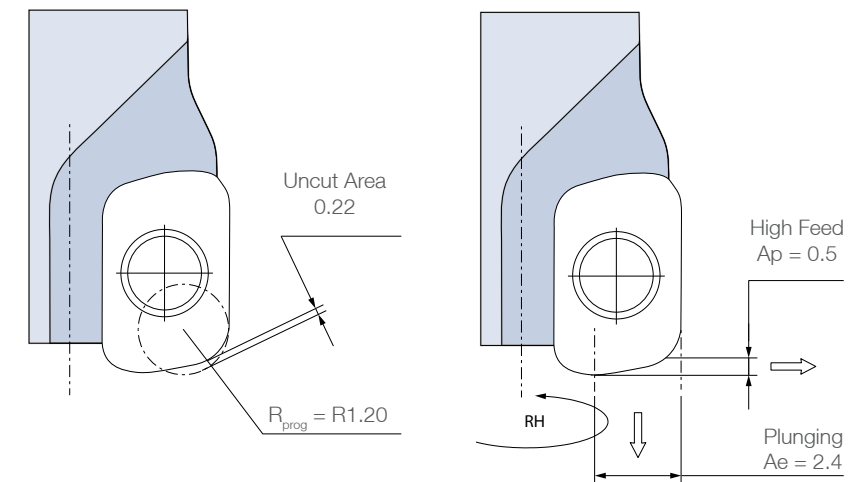

LT 752 / LT 910 - ASSEMBLING INSTRUCTIONS

HOW TO ASSEMBLY LT 752 / LT 910 CUTTERS TO AVOID PREMATURE BREAKAGE

- Due to the small size of these inserts, it is vital that you only use a pre-set torque screw driver (0.4Nm) at all times for assembly and adjustment.
- It is also recommended that during mounting, the insert should be held in place with your finger.
- When using the cutter for the first time, the following start procedure should be followed. This procedure needs to be done only once, the first time the milling cutter perform the first touch on the material.
 1. Start the milling operation and stop it after 10-20 seconds of machining
 2. Tighten the screw again using the pre-set torque screw driver (0.4Nm)
 3. Re-start the milling operation
 4. This procedure will guarantee a precise and real torque force on the screw.

This procedure needs to be done only the first time any you use a new LT 752 milling cutter. After this your cutter should work without issue even after loading new inserts or starting and restarting the machining process.



Keep the insert positioned with the finger, when tightening the screw.

COPY MILLING

EFFECTIVE DIAMETER FOR RPM CALCULATION

When calculating revolution per minute (n), the effective diameter must be taken into account. Refer to the formula below.

$$n = \frac{V_c \times 1000}{D_{\text{eff}} \times \pi}$$

$$D_{\text{eff}} = D1 + \ell$$

Symbol	Designation	Unit
D	Milling Cutter Diameter	mm
D_{eff}	Depth of cut (d.o.c.)	mm
D1	Cutter flat surface	mm
DOC	Depth of cut	mm
iC	Insert Diameter - Inscribed circle	mm
V_c	Cutting Speed	m/min
n	Rotation	rev/min
ℓ	Diameter compensation	mm

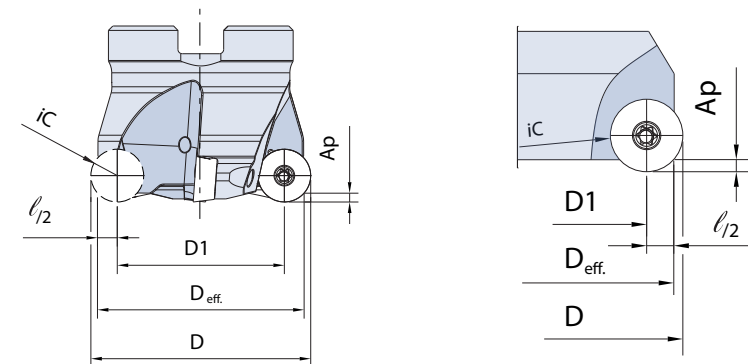

ℓ VALUES FOR DOC VALUES*

iC	DOC (Ap)							
	0.5	1.0	1.5	2.0	2.5	3.0	3.5	4.0
6	3.3	4.5	5.2	-	-	-	-	-
7	3.6	4.9	5.7	6.3	-	-	-	-
8	3.9	5.3	6.2	6.9	-	-	-	-
10	4.4	6.0	7.1	8.0	8.7	-	-	-
12	4.8	6.6	7.9	8.9	9.7	10.4	-	-
16	5.6	7.7	9.3	10.6	11.6	12.5	13.2	13.9

* For min/max depth of cut, please check the cutting parameter pages for each insert.

DRILLING - COOLANT

COOLANT VOLUME REQUIREMENTS

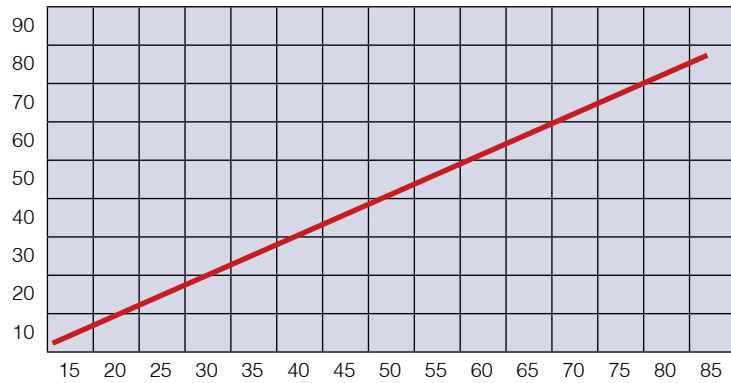

COOLANT PRESSURE REQUIREMENT

Drilling depth	Recommended pressure (Bar)		
	Drill diameter		
	15-25	> 25-40	> 40
< 3 x D	6	4.5	3
≥ 3 x D	12	9	6

HOLE TOLERANCE (BASED ON STABLE CONDITIONS)

Drill length	Hole tolerance (mm)
2 x D	+ 0.20 / - 0.1
3 x D	+ 0.25 / - 0.1
4 x D	+ 0.30 / - 0.1

RECOMMENDED

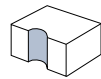

GENERAL DRILLING

* SUITABLE

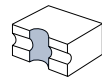

CROSS DRILLING

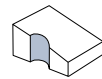

IRREGULAR SURFACE DRILLING

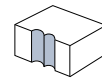

INTERRUPTED DRILLING

* **SUITABLE** Reduce the feed in 50%

MAX. AND MIN. HOLE DIAMETER

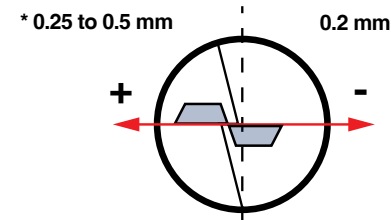

* the maximum diameter adjustment depends on the drill body diameter

Reduce the feed in 50% in case of 4xD drilling

DRILL DIAMETER	INSERT	RADIAL SHIFT	MAX. HOLE (Ø)
13	SPMG O50204	+0.5	14.0
14		+0.5	15.0
15		+0.5	16.0
16	SPMG O60204	+0.5	17.0
17		+0.5	18.0
18		+0.5	19.0
19		+0.5	20.0
20		+0.5	21.0
21		+0.25	21.5
22	SPMG O7T308	+0.5	23.0
23		+0.5	24.0
24		+0.5	25.0
25		+0.5	26.0
26		+0.25	26.5
27		+0.25	27.5
28	SPMG O90408	+0.5	29.0
29		+0.5	30.0
30		+0.5	31.0
31		+0.25	31.5
32		+0.25	32.5
33		+0.25	33.5

TROUBLESHOOTING

1 - OVERSIZED AND UNDERSIZED

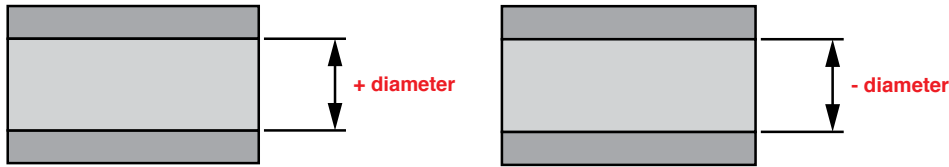

ROTATING DRILLS

1. Check the coolant flow and increase it, clean machine filter, clean the drill holes
2. Check the coolant pressure and volume according to the drill diameter and length of hole

NON ROTATING DRILLS

1. Check the lathe alignment
2. Rotate the drill 180

2 - PIN IN HOLES

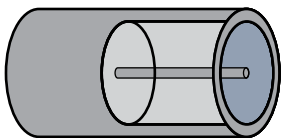

ROTATING DRILLS

1. Check the coolant pressure and volume according to the drill diameter and length of hole
2. Use a shorter drill

NON ROTATING DRILLS

1. Check the coolant flow and increase it, clean machine filter, clean the drill holes
2. Check the lathe alignment
3. Use a shorter drill

3 - VIBRATIONS

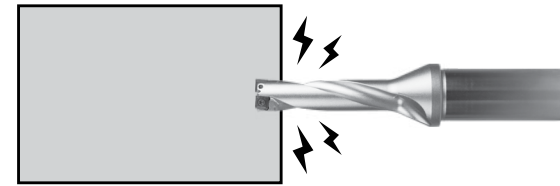

ROTATING DRILLS

1. Check the coolant pressure and volume according to the drill diameter and length of hole
2. Use a shorter drill

NON ROTATING DRILLS

1. Check the coolant flow and increase it, clean machine filter, clean the drill holes
2. Check the lathe alignment
3. Use a shorter drill

4 - THE IMPORTANCE OF COOLANT IN DRILLING

Coolant in drilling is always recommended, independent of the workpiece material, because it helps chip evacuation, improves hole quality and increases tool life.

The best results are achieved with internal coolant, when it is not available, external coolant can help to achieve acceptable results if the coolant noses are well directed to the drill flutes and if the coolant pressure is good.

⚠ Drilling without coolant is not recommended, mainly because the chips can get stuck inside the hole causing the breakage of the drill. If it's unavoidable due to machine limitations, the cutting speed should be reduced and the "wood peck" drilling technique should be applied (after drilling a few millimeters, the drill is retracted out from the hole to ensure no chips are stuck on the drill, and then continue drilling).

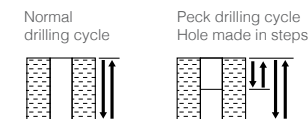

HELICAL INTERPOLATION

DRILLING - IRREGULAR WORK SURFACES

The example below shows a hole-making operation in a workpiece with irregular surface and weak set-up.

When using a drill body, until the full engagement is achieved, the operation is unbalanced causing vibrations, demanding a large feed rate reduction, with high risk of insert breakage. It can reduce the productivity in some cases.

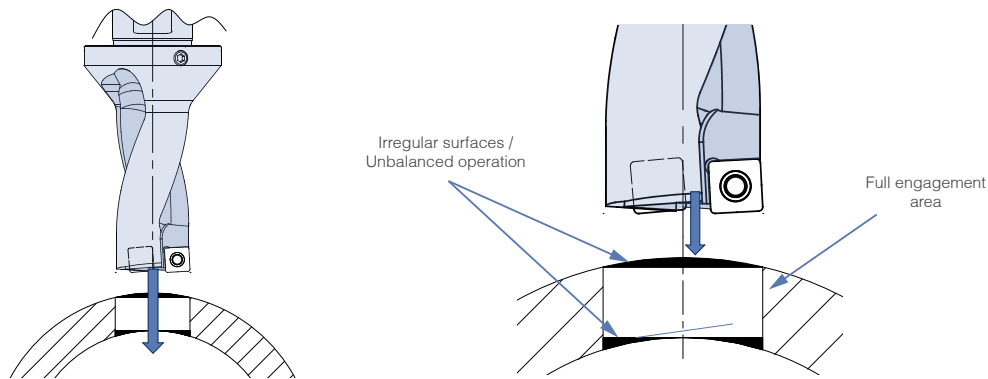

HELICAL MILLING - IRREGULAR WORK SURFACES

In this case, the helical milling machine strategy is the best option because it has:

1. Good chip control and evacuation
2. Better surface quality and dimensional tolerances
3. Lower power consumption and vibration tendencies = more machining stability

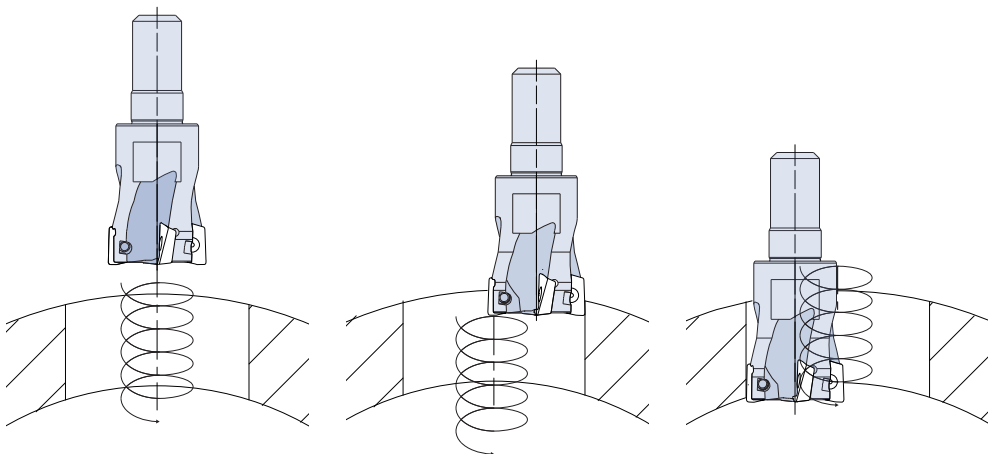

HELICAL MILLING - CUTTING DIRECTION

To maximize performance, the Helical Milling strategy must be applied with the correct cutting direction. For holemaking operations such as drilling and boring, CCLW is recommended for climb milling to keep the chip formation from thick to thin.



Counterclockwise direction (CCLW)

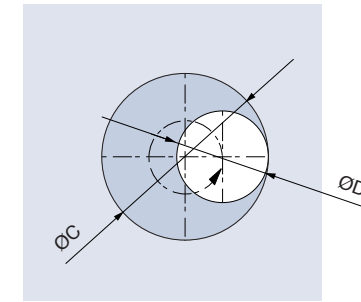

D = Milling Cutter Diameter
C = Hole Diameter

HELICAL MILLING - FEED RATE COMPENSATION

For Helical Milling, we need to compensate the feed rate, to keep the chip thickness like the same when performing a Linear Milling operation.

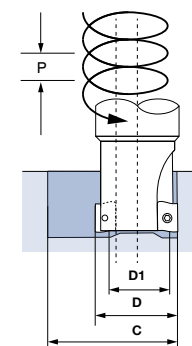

D = 16
C = 30

LINEAR MILLING

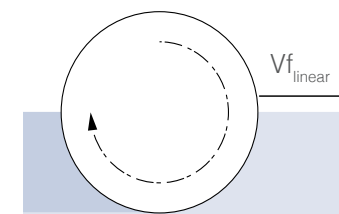

$$Vf_{linear} = fz \times RPM \times Z$$

RPM = 3600 rev/min
fz = 0.05 mm/tooth
Z = 4
Vf_{linear} = 720 mm/min
Climb Milling

CIRCULAR MILLING

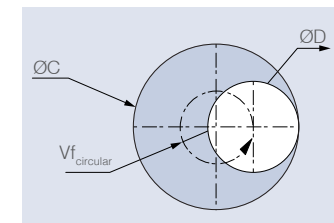

$$Vf_{circular} = ((C-D)/C) \times Vf_{linear}$$

Feed Rate Compensation

$((C-D)/C) \times \text{Linear feed Rate}$
 $((30-16)/30) \times 720 \text{ mm/min}$
 $(14/30) \times 720 \text{ mm/min}$
 $0.466 \times 720 \text{ mm/min} = 336 \text{ mm/min}$

Simplify your process

Decrease your tooling costs

Minimize your machining down time

Increase your production efficiency





LAMINA
TECHNOLOGIES

HEADQUARTERS

Lamina Technologies SA Switzerland

Rue Pythagore, 2
1400 Yverdon-les-Bains
Switzerland
+41 (0)24 423 55 55
info@lamina-tech.ch
www.lamina-tech.ch

FOLLOW US

-  /LaminaTechnologies
-  /LaminaTechnologiesHQ
-  /LaminaTech
-  /LaminaTechnologies

Proud sponsor of
Junior National Team



SUBSIDIARIES

Lamina Technologies Deutschland GmbH

Athenslebener Weg 33
39418 Staßfurt
Germany
+49 (3925) 329 277
info@lamina-tech.de
www.lamina-tech.ch

Lamina Technologies (France) SA

15 Rue Bernard Palissy, Entrepot Jeantet STJ
25300 Granges Narboz
France
+33 (0)6 60 52 98 72
info@lamina-tech.fr
www.lamina-tech.ch

Lamina Technologii LLC Russia

Kantemirovskaya str. 58 Office 6023
115477 Moscow
Russia
+7 499 653 93 56
info@lamina-russia.ru
www.lamina-tech.ch

Lamina Trading (Shanghai) Co.,Ltd

Room 340, Building No.1,
No. 526 Fute 3rd Road East, Pilot Free Trade Zone
200131 Shanghai
China
+86 21 6479 0515
info-cn@lamina-tech.ch
www.lamina-tech.ch

Lamina Technologies do Brasil Ltda.

Avenida Macuco, 726 - Cj. 1805/1806/1807
04523-001 Moema
Sao Paulo-SP
Brazil
T. +5511 2344-7890
F. +5511 2344 7888
info@lamina-tech.ch
www.lamina-tech.ch

Lamina Teknolojileri Kesici Takimler Sanayi ve Ticaret Limited Sirketi

Cihangir Mahallesi, Petrol Ofisi Caddesi
Şehit Komando Onbaşı Uğur Hancı Sokak No:5
Avcılar / İstanbul / Turkey 34315
+90 212 292 09 21
info@laminateknolojileri.com.tr
www.lamina-tech.ch

PT. Lamina Technologies Indonesia

Ruko The Podium Mataram - A 9 Jl.Mataram
Lippo Cikarang - Bekasi 17550
Indonesia
+62 (21) 2210 4851
info@lamina-tech.ch
www.lamina-tech.ch